

# APIA

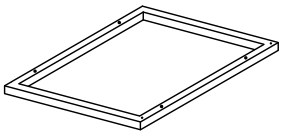

**A × 1**

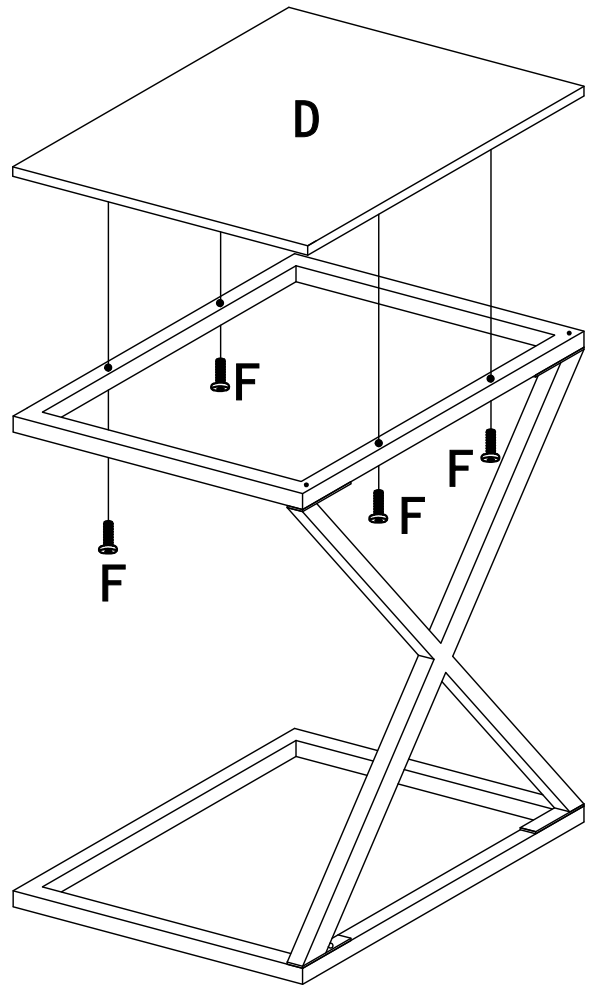
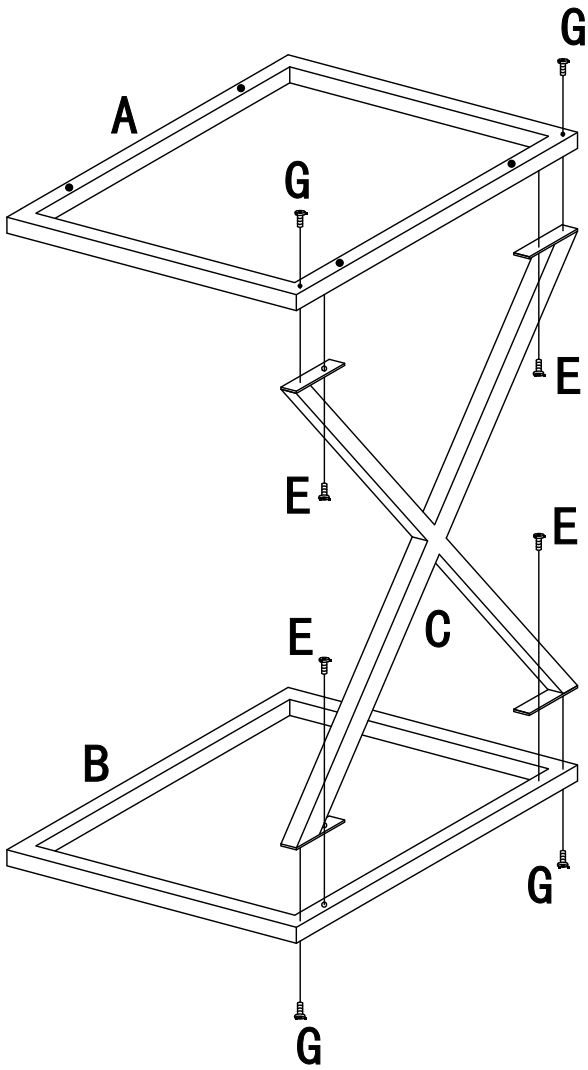
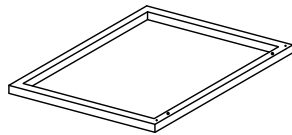

**B × 1**

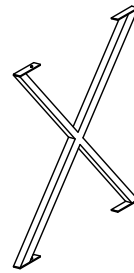

**C × 1**

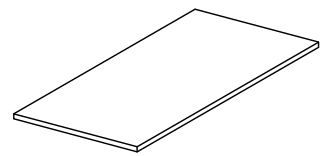

**D × 1**



**M6 × 12mm**

**E × 4**



**M6 × 30mm**

**F × 4**

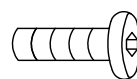

**M6 × 27mm**

**G × 4**

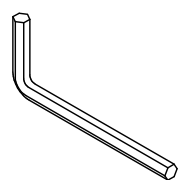

**H × 1**