

JOHAN 2 NEW 01

Art.-Nr.

278205
278004
278005

| | |
|--|------|
| | 1500 |
| | 735 |
| | 674 |
| | mm |

1/2
ZO

| | | | | | | |
|--|-------|--|----------|----|------|---|
| | | | | | | |
| | 30min | | ≤ 0,5 kg | 3m | PZ 2 | 4 |

| ID | ID | | | |
|-------|----|-------------|----|-----|
| 17605 | ② | 1500*674*22 | 1x | 1/1 |
| 12818 | ③ | 713*580*22 | 1x | 1/1 |
| 12819 | ④ | 1446*285*16 | 1x | 1/1 |
| 12820 | ⑤ | 713*580*22 | 1x | 1/1 |



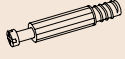

| | | | | | | | |
|------|------|------|------|------|------|------|------|
| | | | | | | | |
| A 4x | B 4x | C 4x | D 7x | E 7x | F 1x | G 6x | H 4x |

| | | | | | | | | | |
|---|---|---|---|---|---|---|---|---|---|
| | | | | | | | | | |
| ✓ | ✗ | ✗ | ✓ | ✗ | ✓ | ✗ | ✓ | ✗ | ✗ |

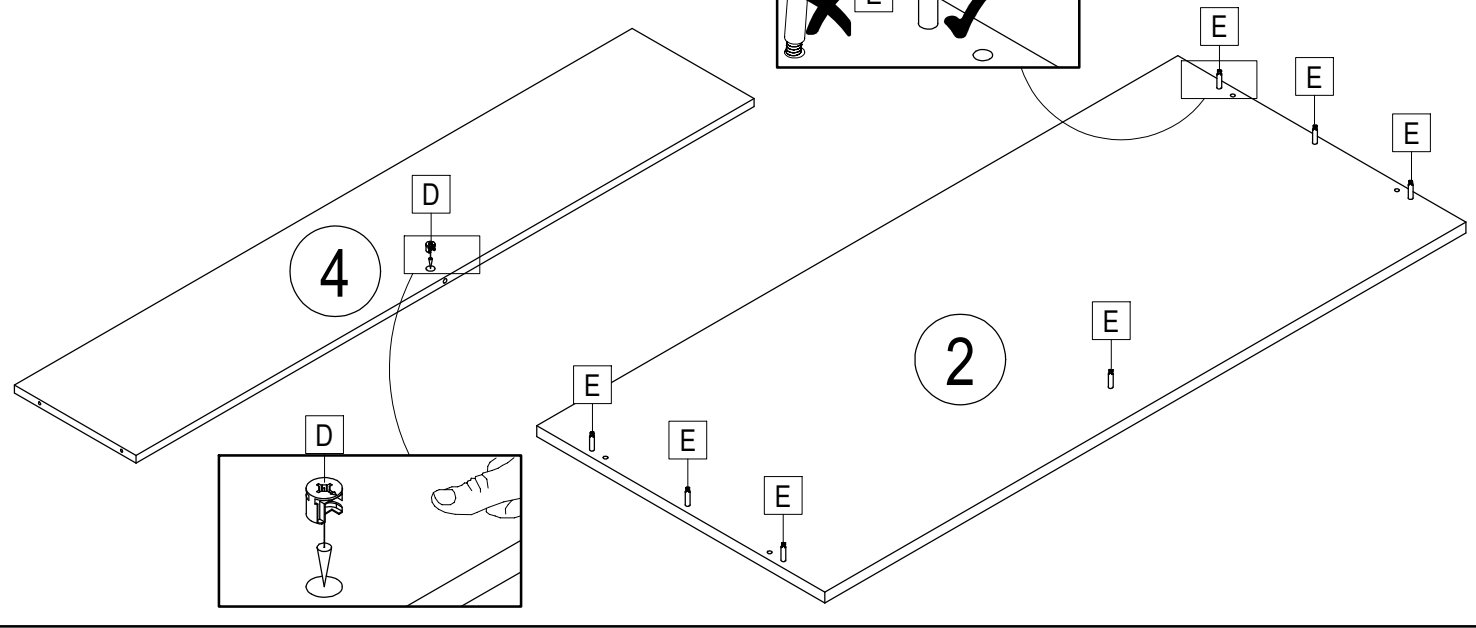
| | | |
|------|------|------|
| | | |
| B 4x | C 4x | D 6x |

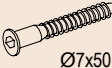
| | | | |
|--|--------|---|----|
|  | Ø15x13 |  | |
| D | 1x | E | 7x |



| | | | | | | | |
|--|-------|---|---|---|----|---|----|
|  | Ø7x50 |  |  |  | | | |
| A | 4x | F | 1x | G | 6x | H | 4x |

