











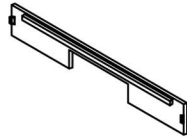











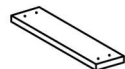

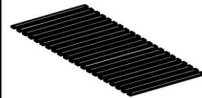

NÁVOD NA MONTÁŽ

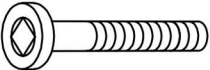
MODEL: KESADA

160x200
1/4
(CF 8949 - P)

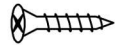
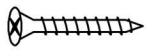
A ČELO ZÁHLAVÍ 1x 	B ČELO ZÁNOŽÍ 1x 	C BOČNICE 2x 	D STŘEDOVÁ LIŠTA 1x 	E PODPORNÁ NOHA 2x 	F BOČNICE-PODPORNÁ NOHA 4x 
G NOHY 4x 	H ČELO VELKÉ ZÁSUVKY 1x  (1)	I ZADNÍ ČELO VELKÉ ZÁSUVKY 1x  (2)	J BOK MALÉ ZÁSUVKY 6x  (3)	K DNO VELKÉ ZÁSUVKY 1x  (4)	L ČELO MALÉ ZÁSUVKY 2x  (5)
M ZADNÍ ČELO MALÉ ZÁSUVKY 1x  (6)	N DNO MALÉ ZÁSUVKY 2x  (7)	O ZPEVNĚJÍCÍ DESKA -VELKÁ 7x  (8)	P ZPEVNĚJÍCÍ DESKA -MALÁ 4x  (9)	Q ROŠT 21x 	

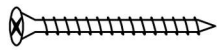
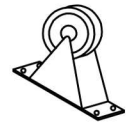
KOVÁNÍ K POSTELI

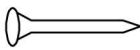
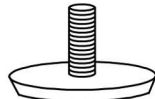
1 ŠROUB JCBC M6 x40 2x 	2 PODPĚRA KOV 6x 	3 IMBUSOVÝ KLÍČ M4 x 65mm 1x 	4 IMBUSOVÝ KLÍČ M5 x 70 mm 1x 	5 CSK M3.5 x16 mm 60x 
6 CSK M4 x 28 mm 8x 	7 CSK M4 x 32 mm 45x 	8 CSK M4 x 50 mm 32x 	9 KOLEČKO 14x 	10 PLASTOVÝ KOLÍK 8x 
11 HŘEBÍKEM 6/8 24x 	12 NASTAVITELNÝ ŠROUB 2x 			

1

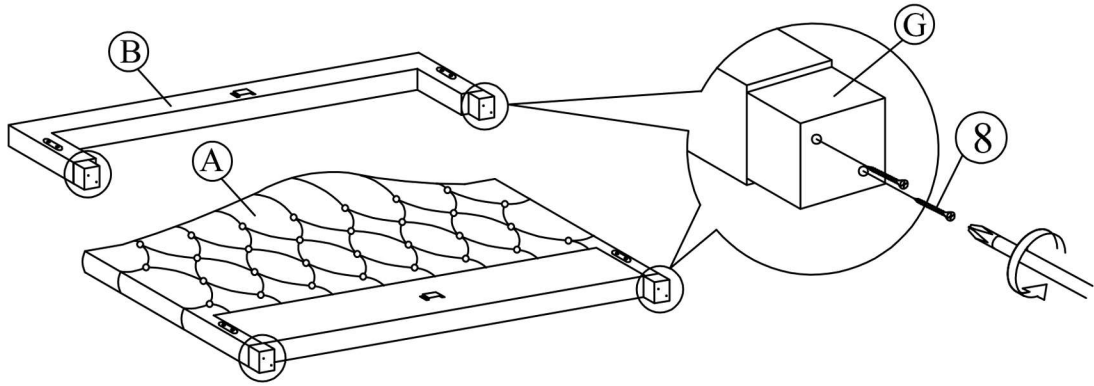

2

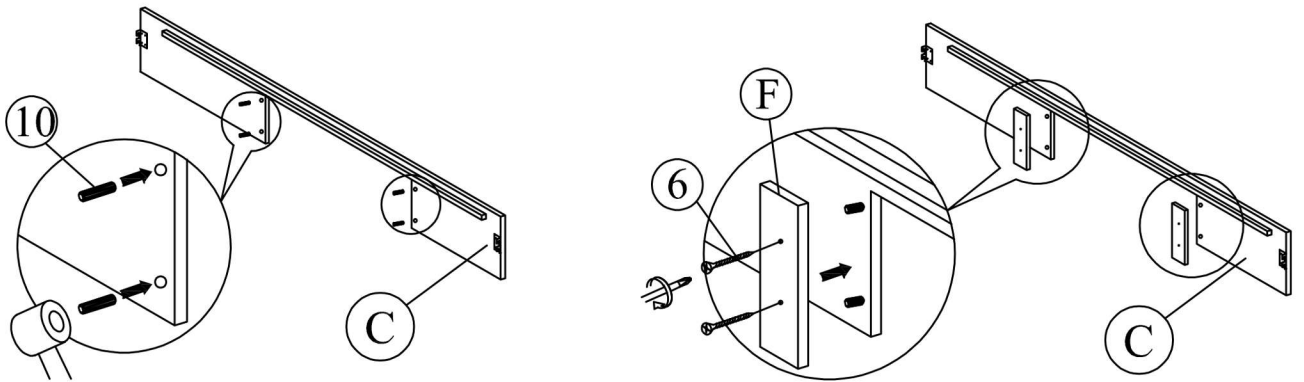

3

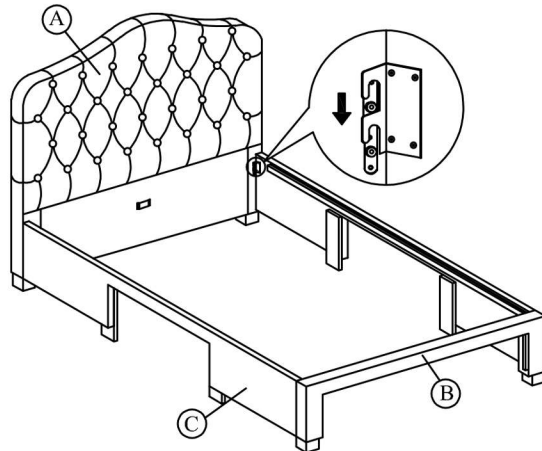

4

UPOZORNĚNÍ

Udržujte nastavitelný šroub asi 5 až 8 mm od podlahy.

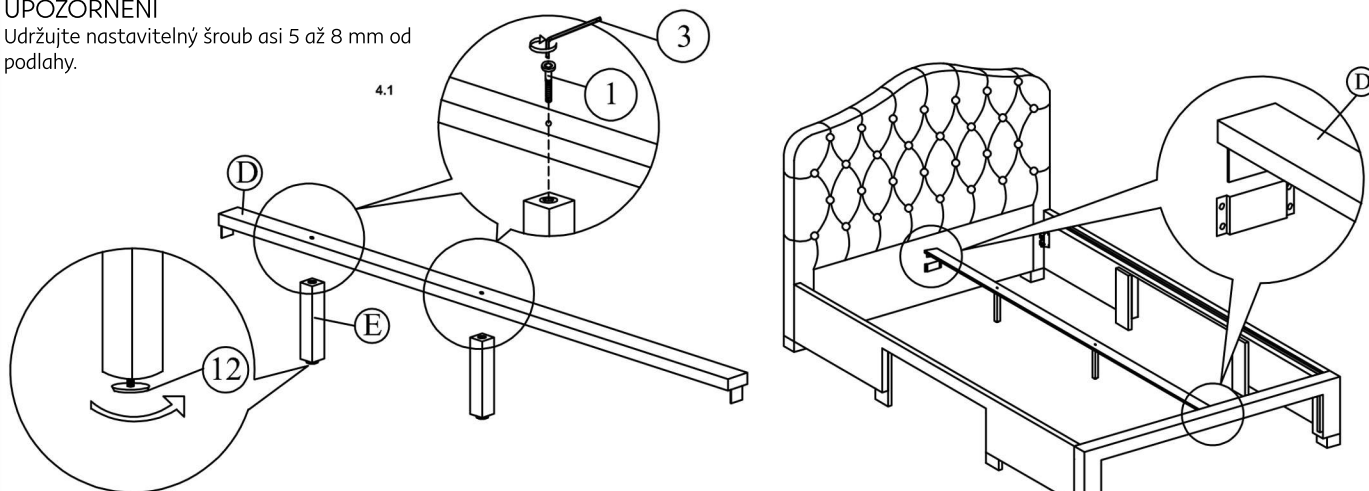

5

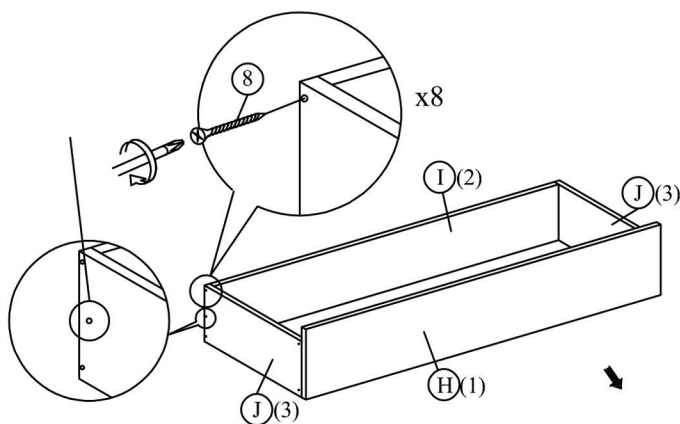

6

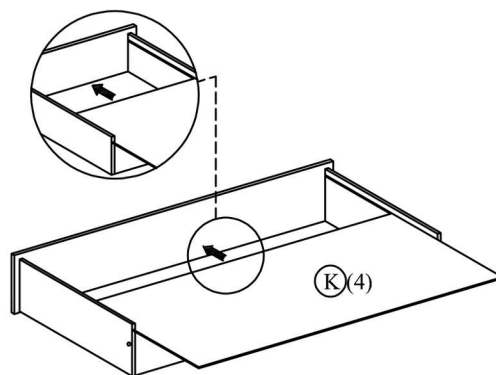

7

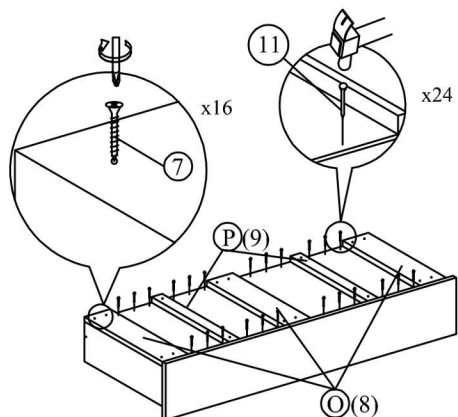

8

