







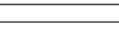

| | | | |
|---|----|-----|---|
| ① | 36 | 170 |  |
| ② | 21 | 265 |  |
| ③ | 28 | 545 |  |
| A | 4 | |  |
| B | 24 | |  |
| C | 2 | |  |
| D | 12 | |  |
| 0 | 14 | |  |
| M | 1 | |  |

1



2

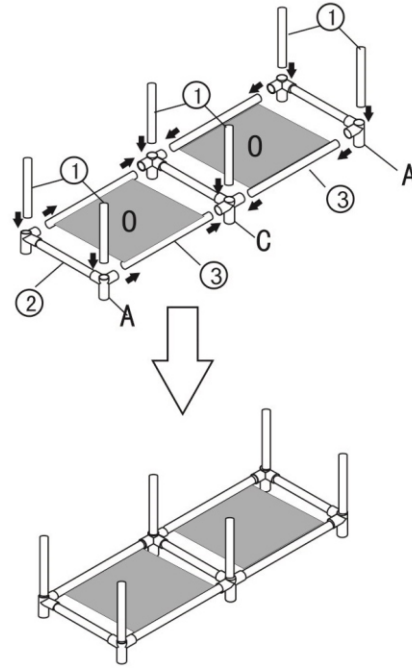
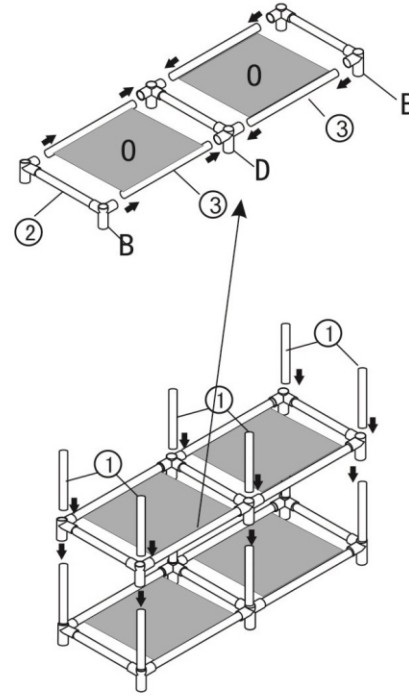

3

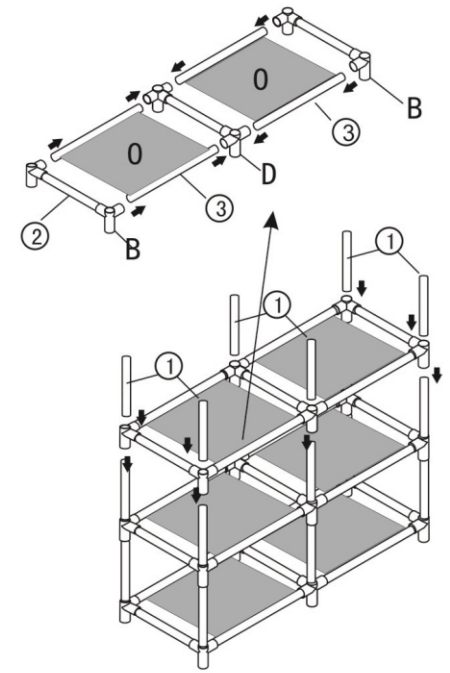

4

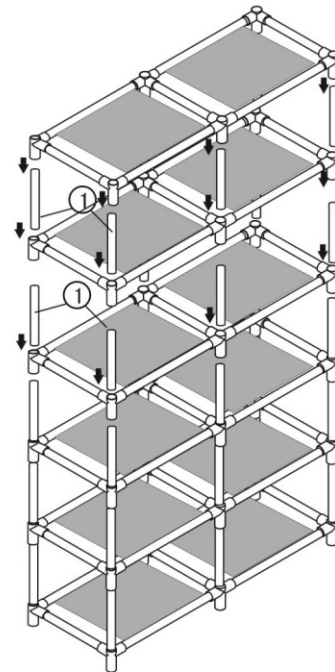

5

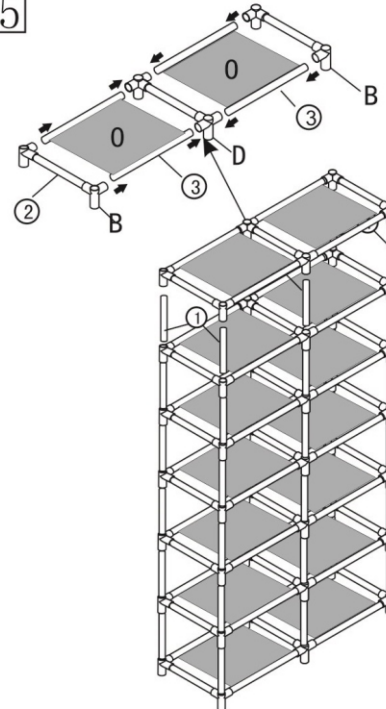

6

