

SELENE TYP 1

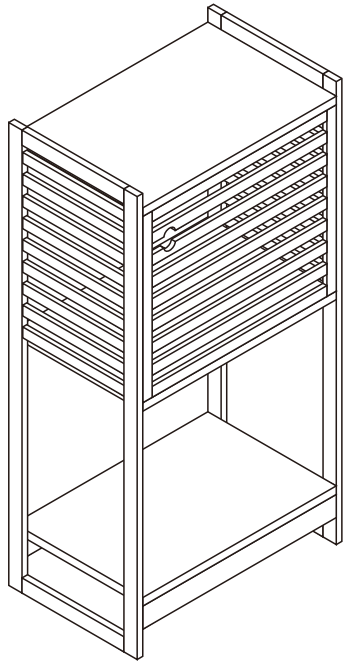

A



x16

B



x2

C



x1

D



x1

E



x4

F



x1

a

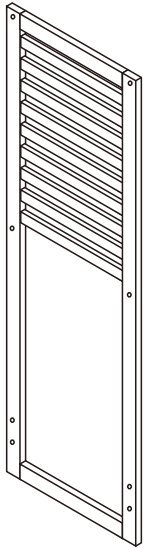

x2

b

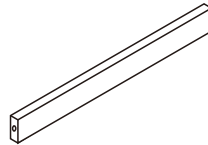

x2

c

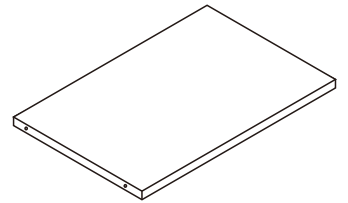

x1

d

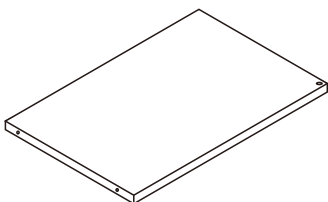

x1

e

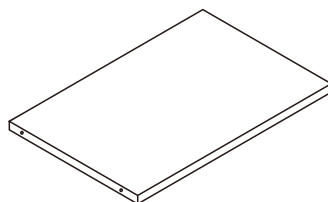

x1

f

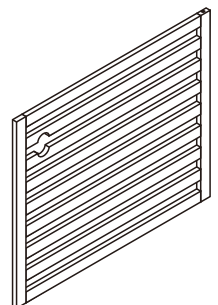

x1

