

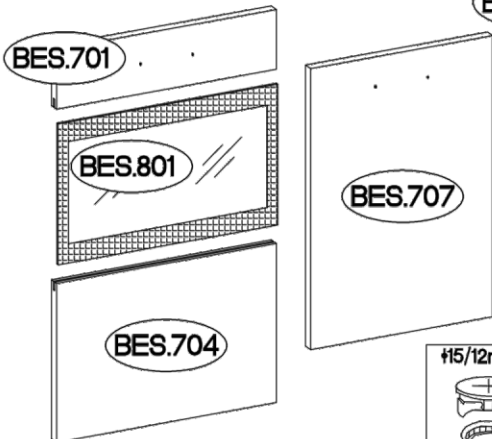

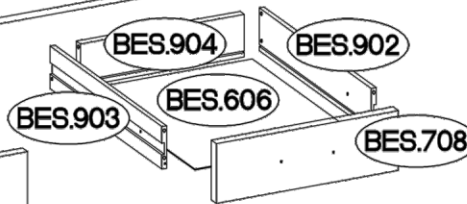

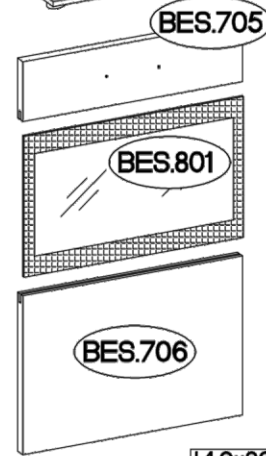

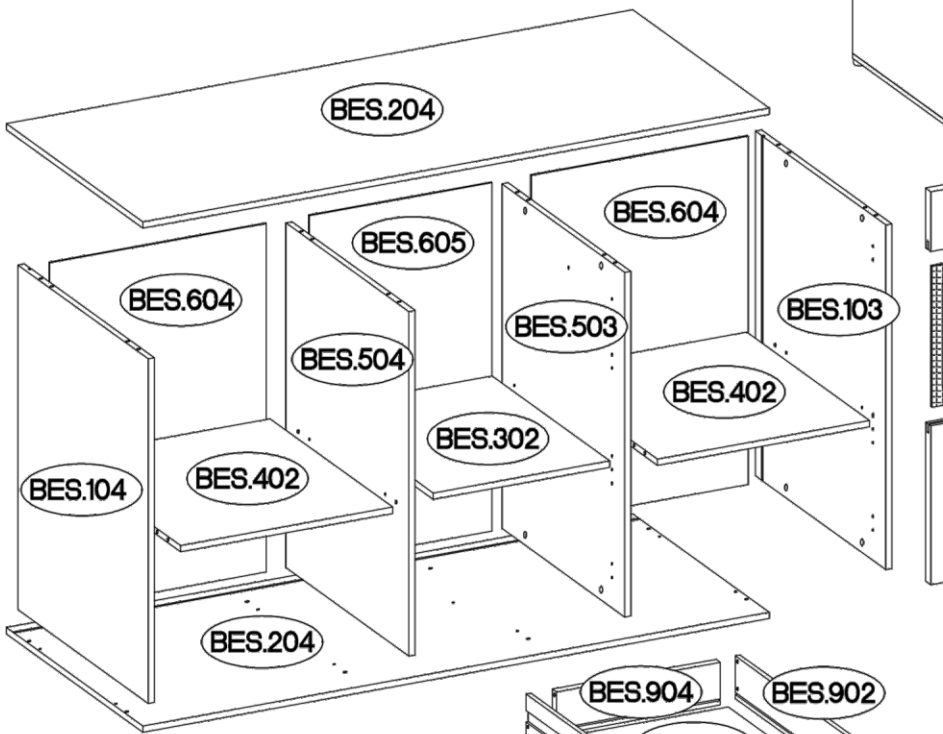

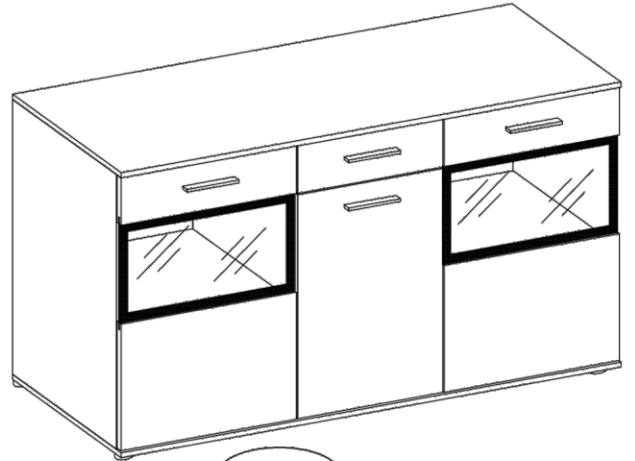
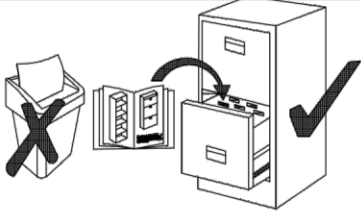
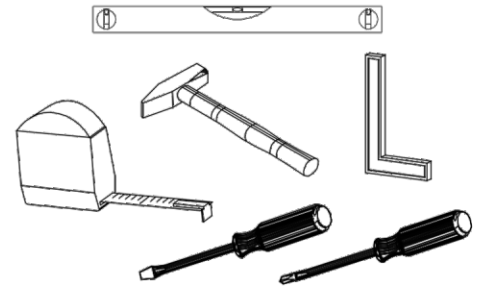
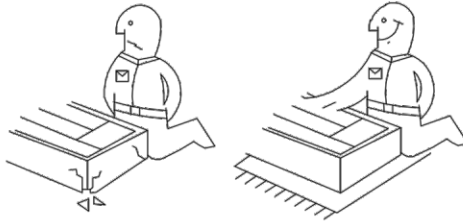
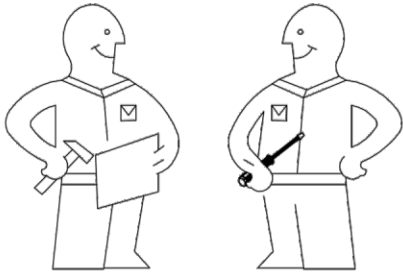











# BREAK

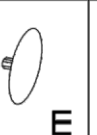
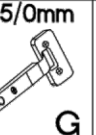

				L2
			10	
			G1	L9
	2	1		
			R2	S11
8	4	1		
			P14	F10
6	6	2		
			P7	M2
16	4	1		
			C	A
24	30	24		
			E	G
24	6	8		
			P5	O11
17	1			

1

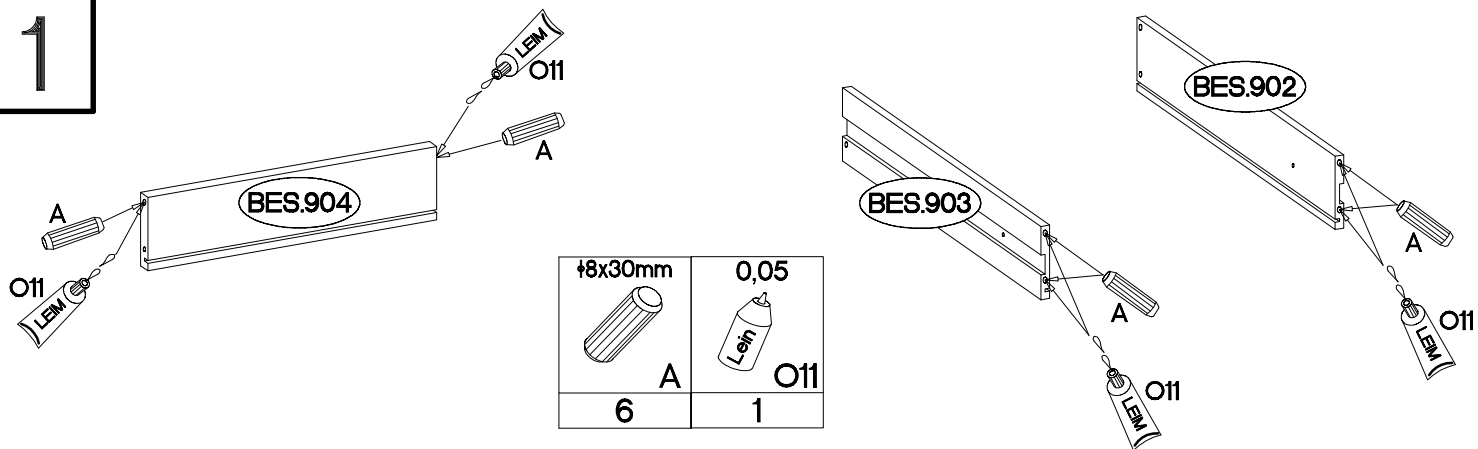



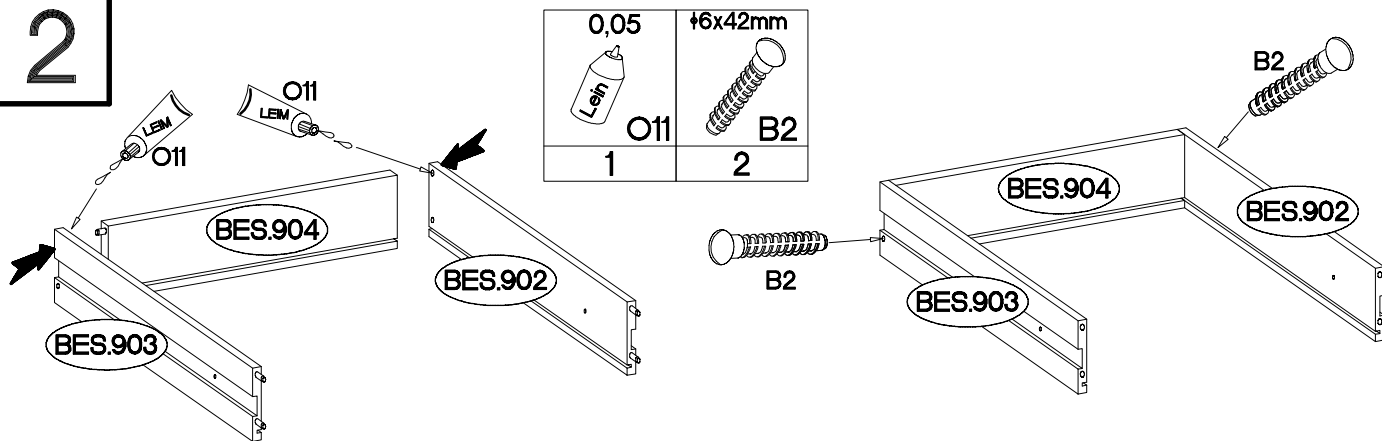

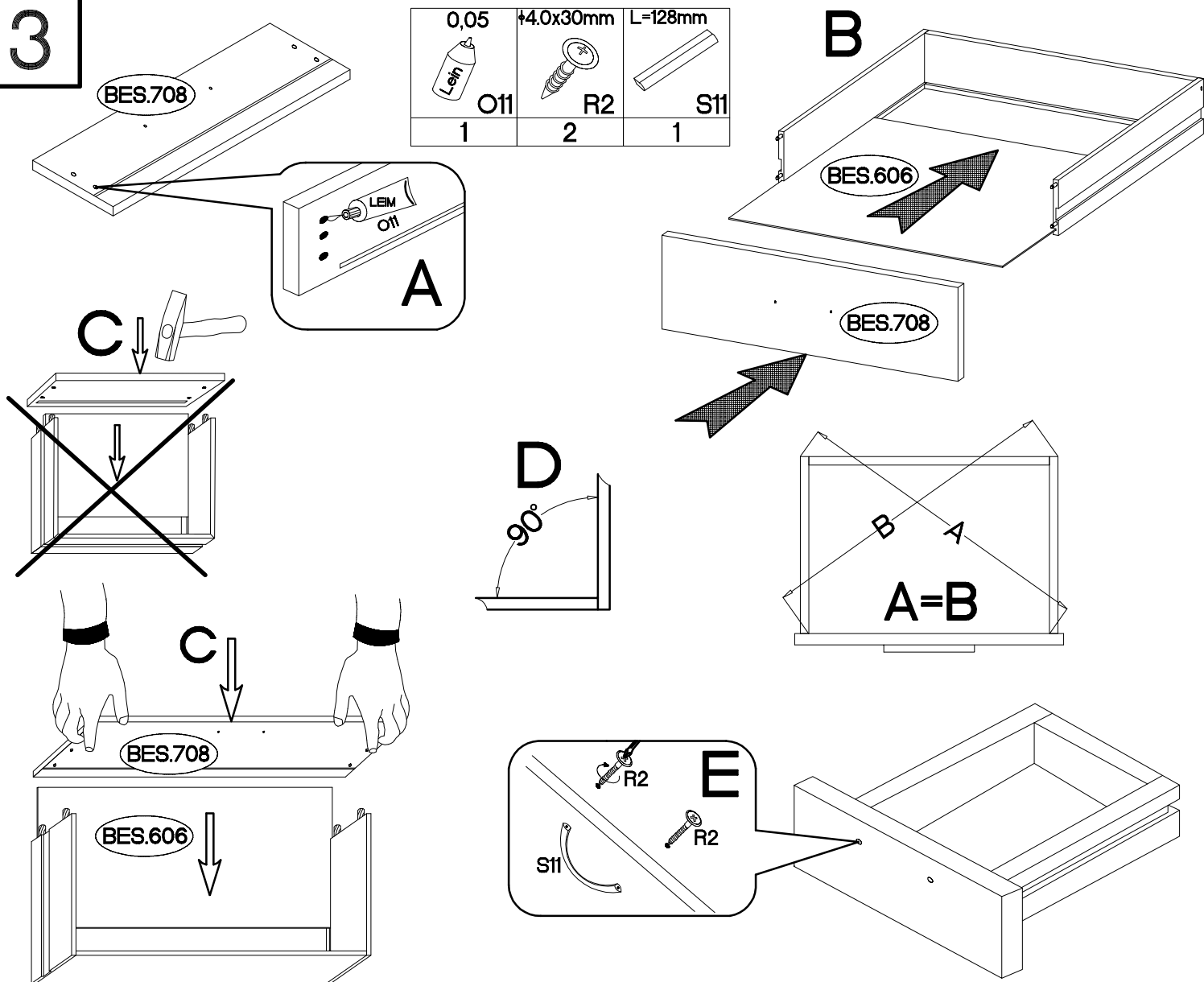

2



3



 C 24	 A 24	 D2 24	 P14 6	 F10 6	 M2 4	 I4 1
---	---	--	--	--	---	--

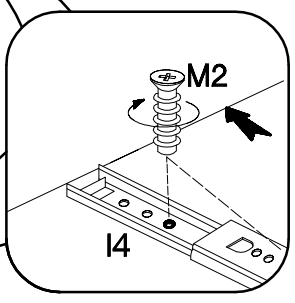
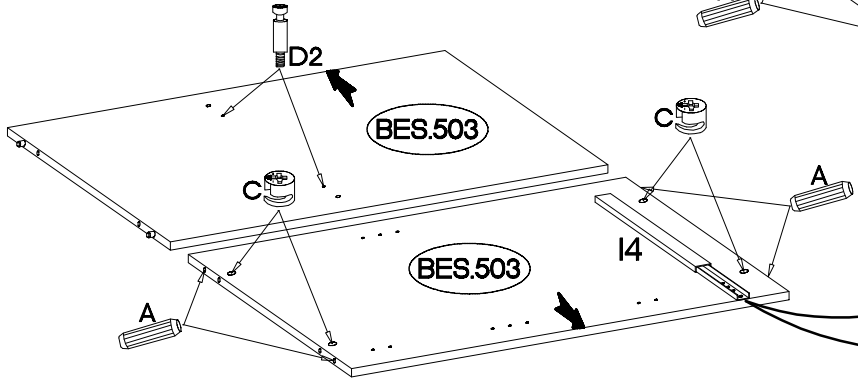
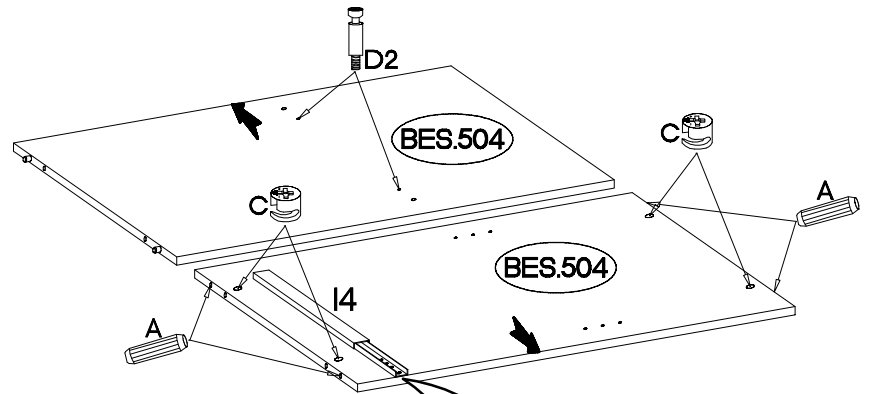
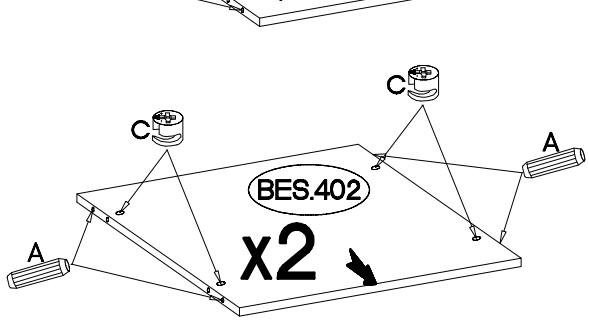
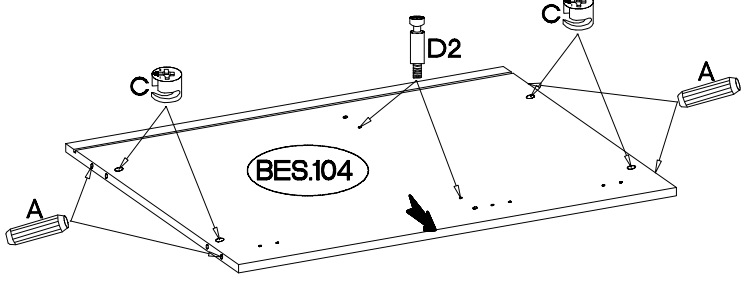
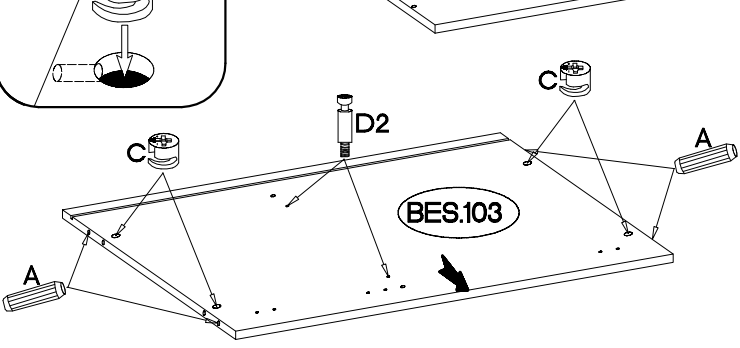
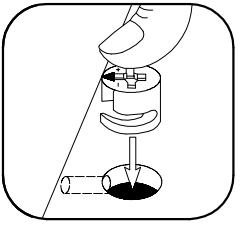
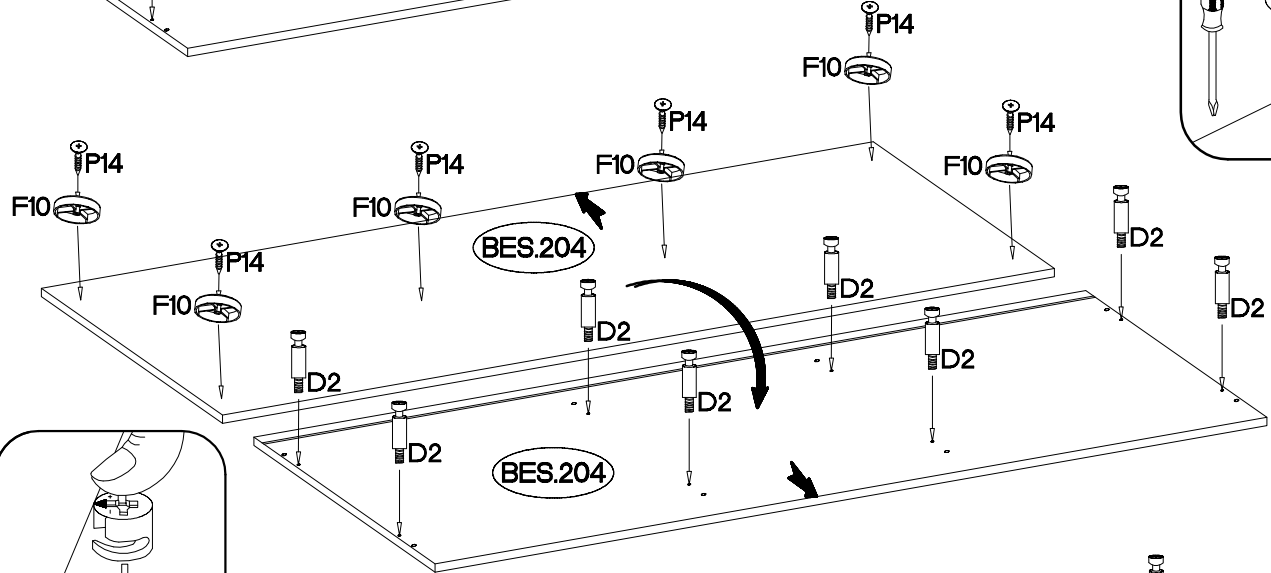
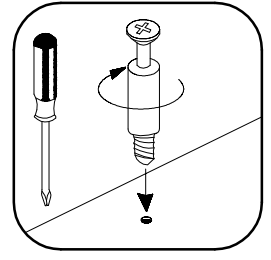
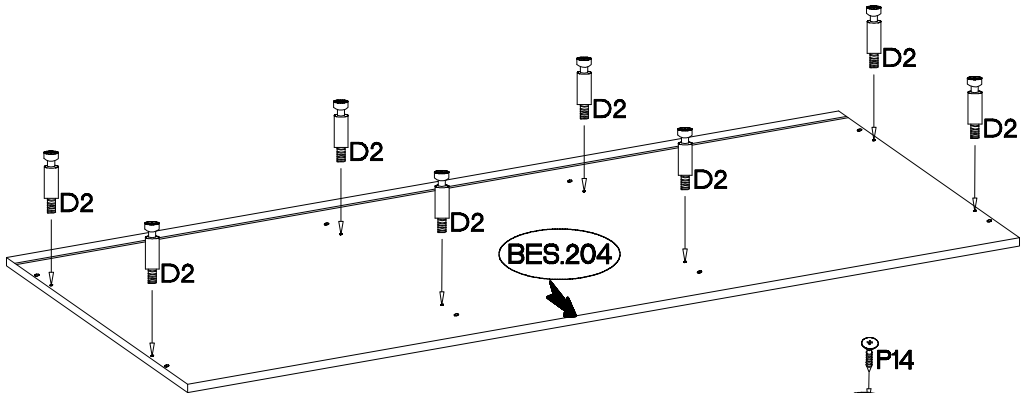
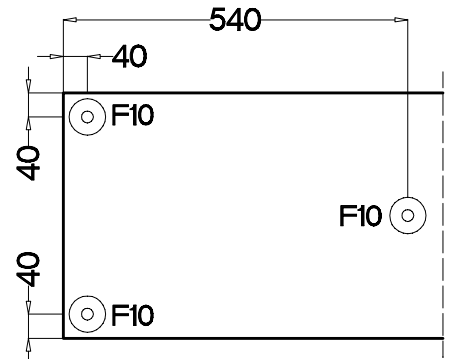

5

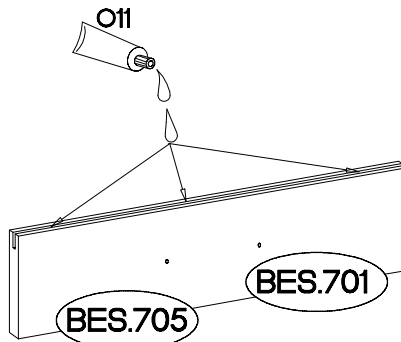
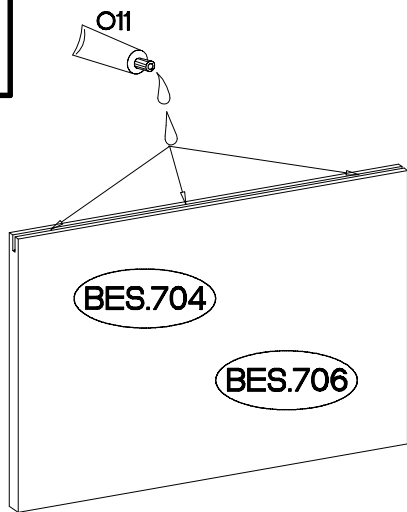

0,05
Lein
O11
1

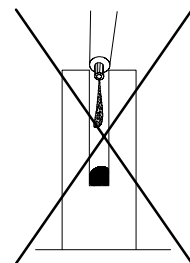
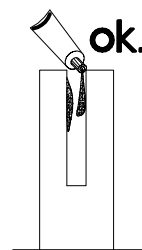

6

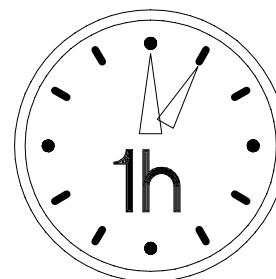
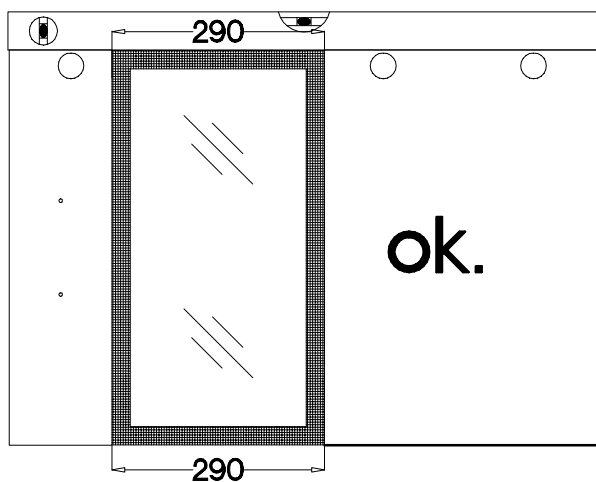
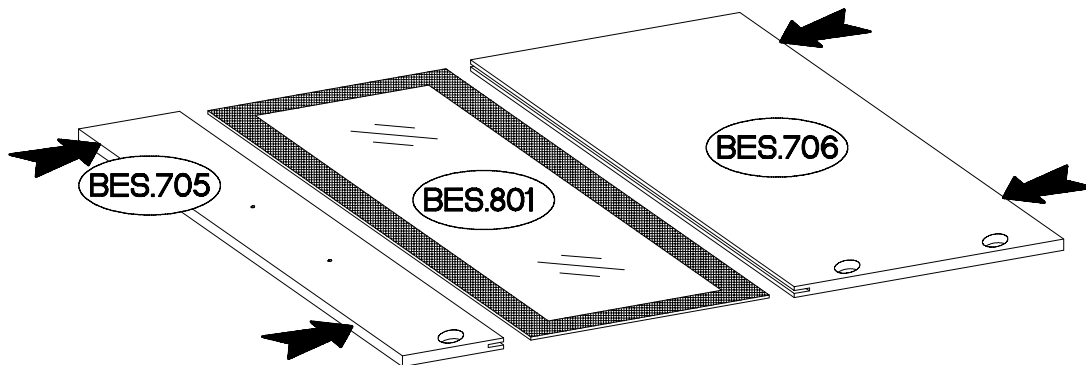
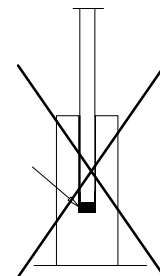
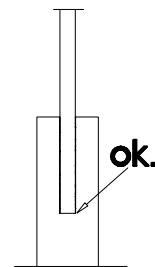
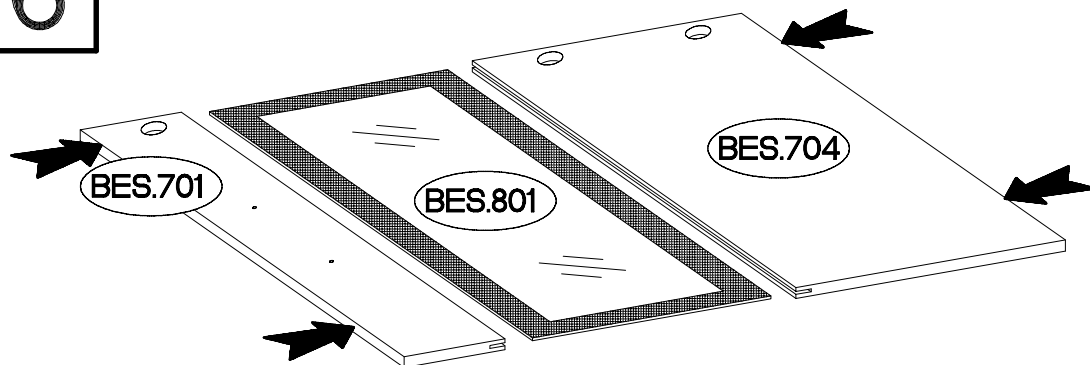

7

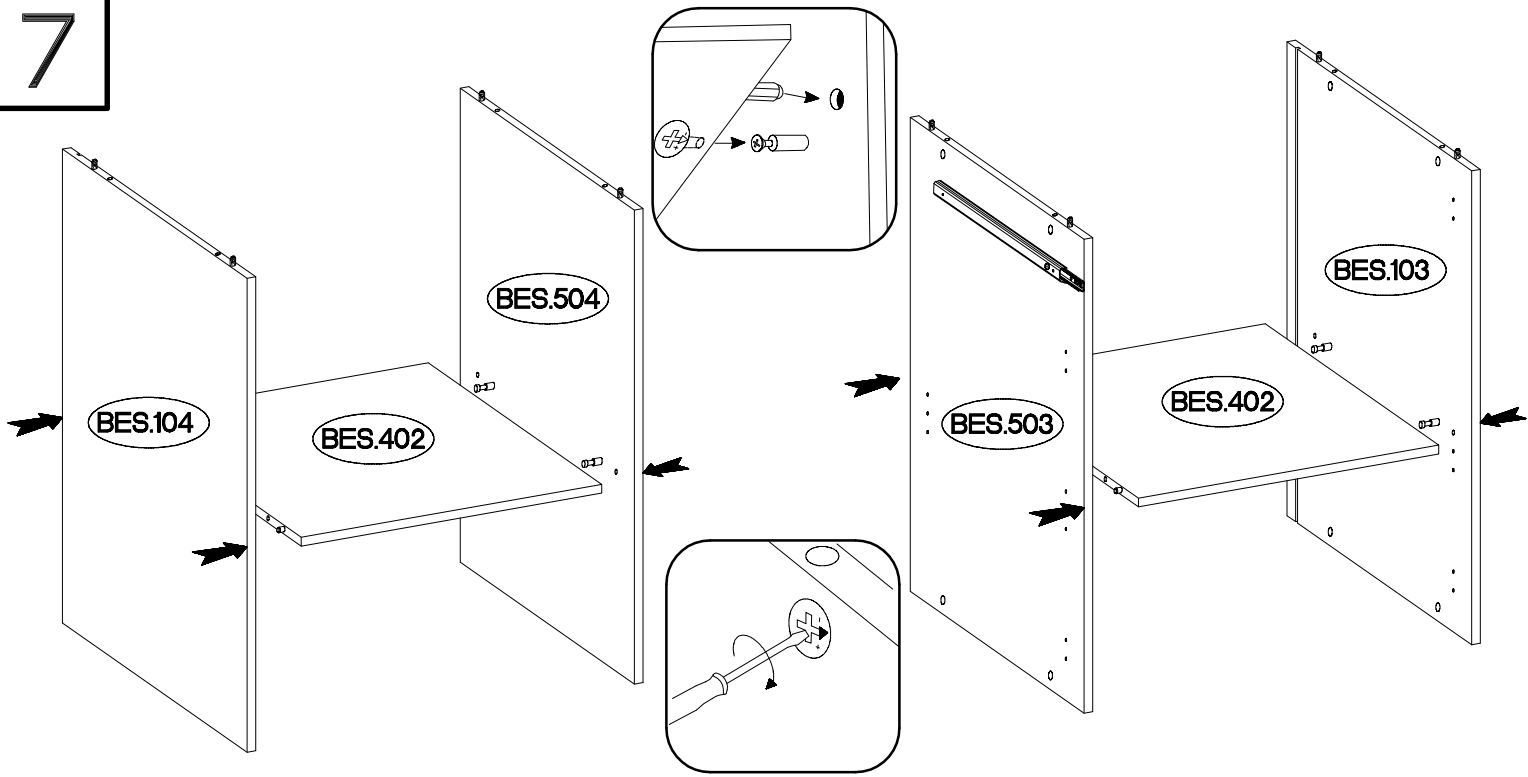

8

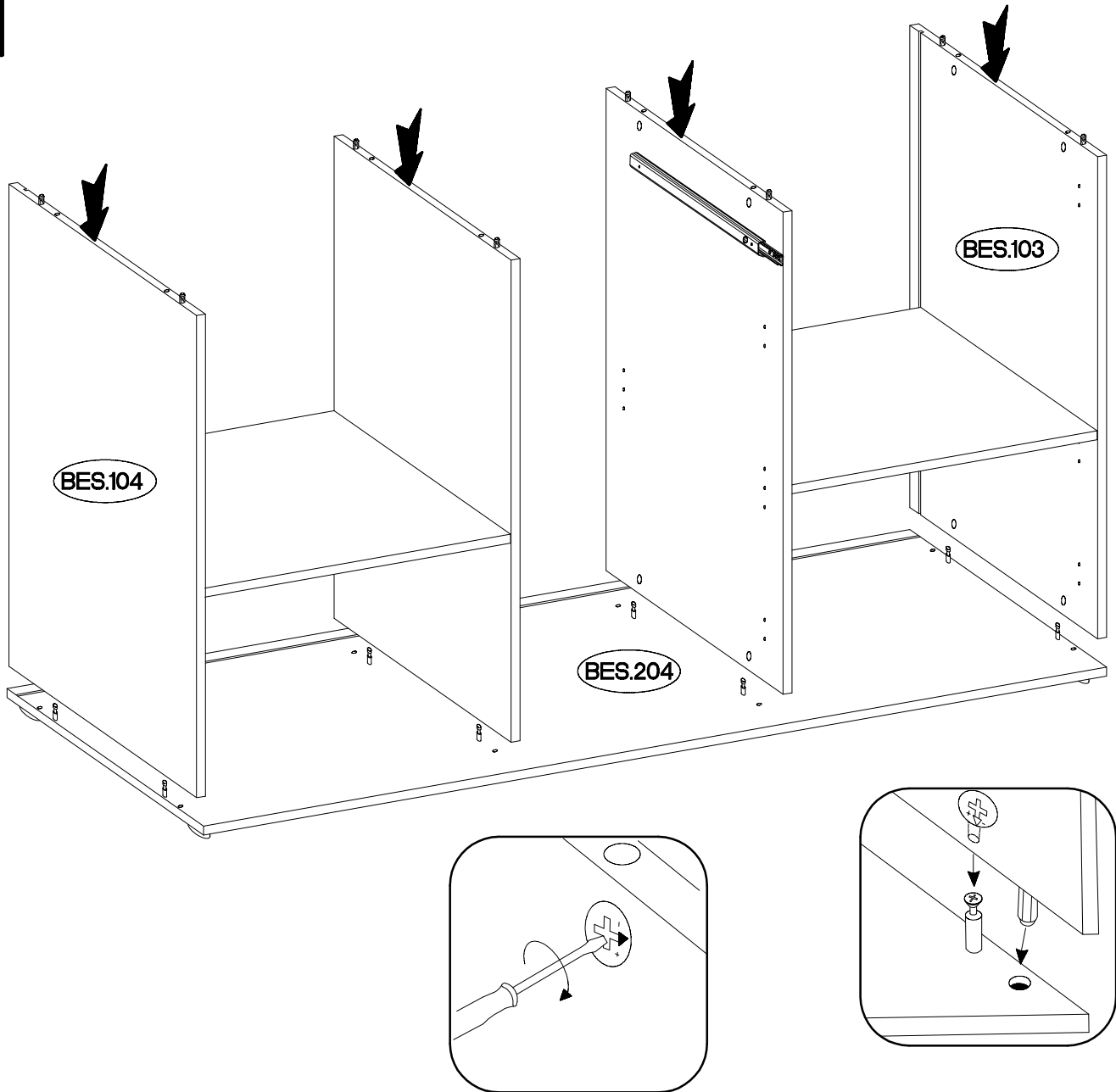

9

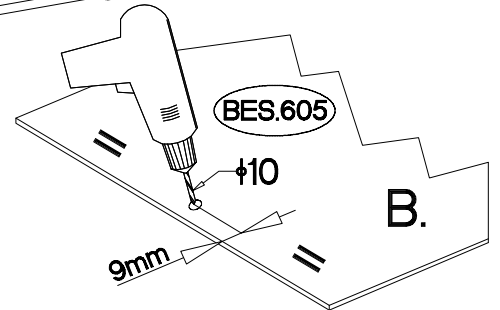
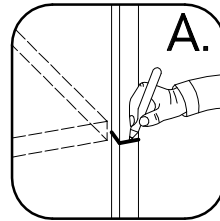
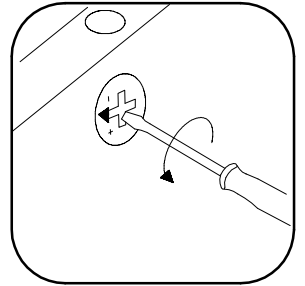
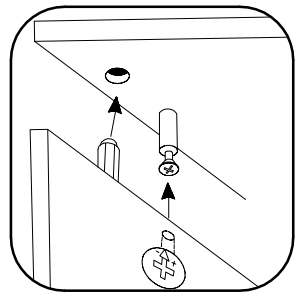
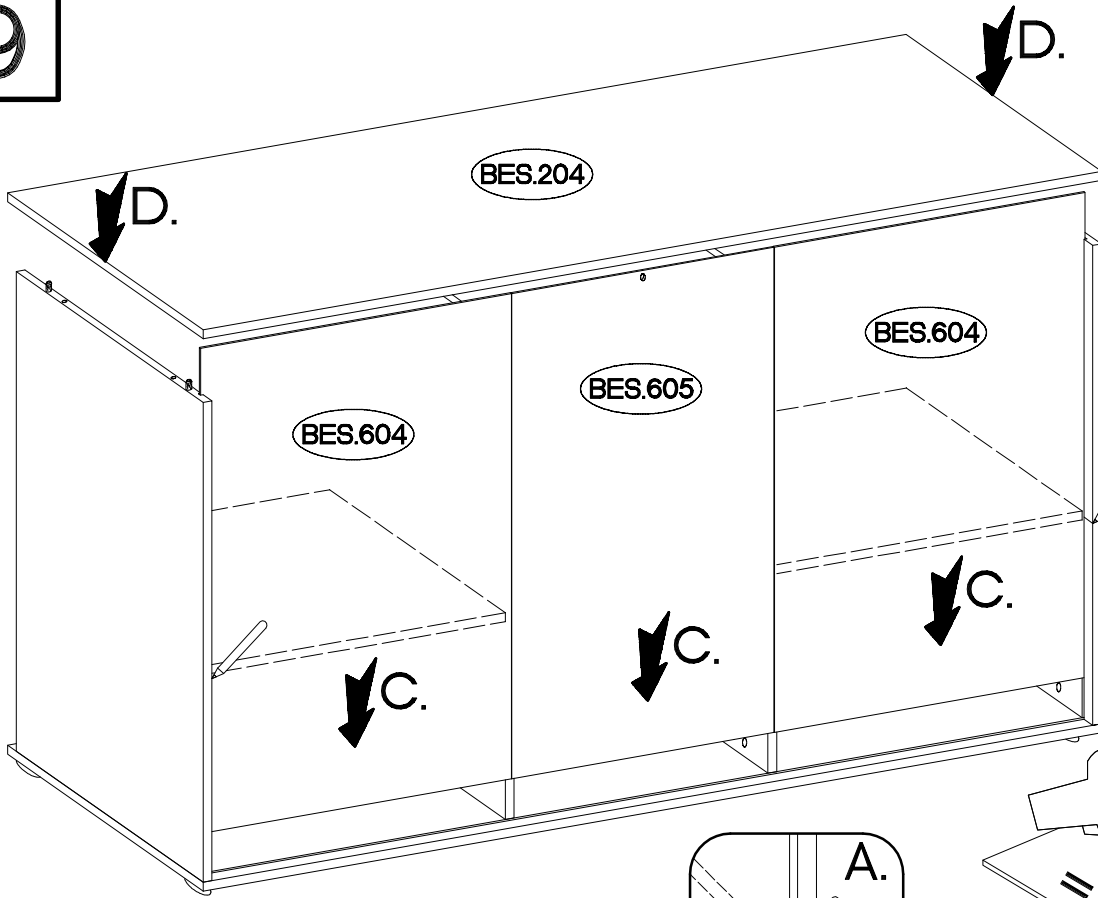

10

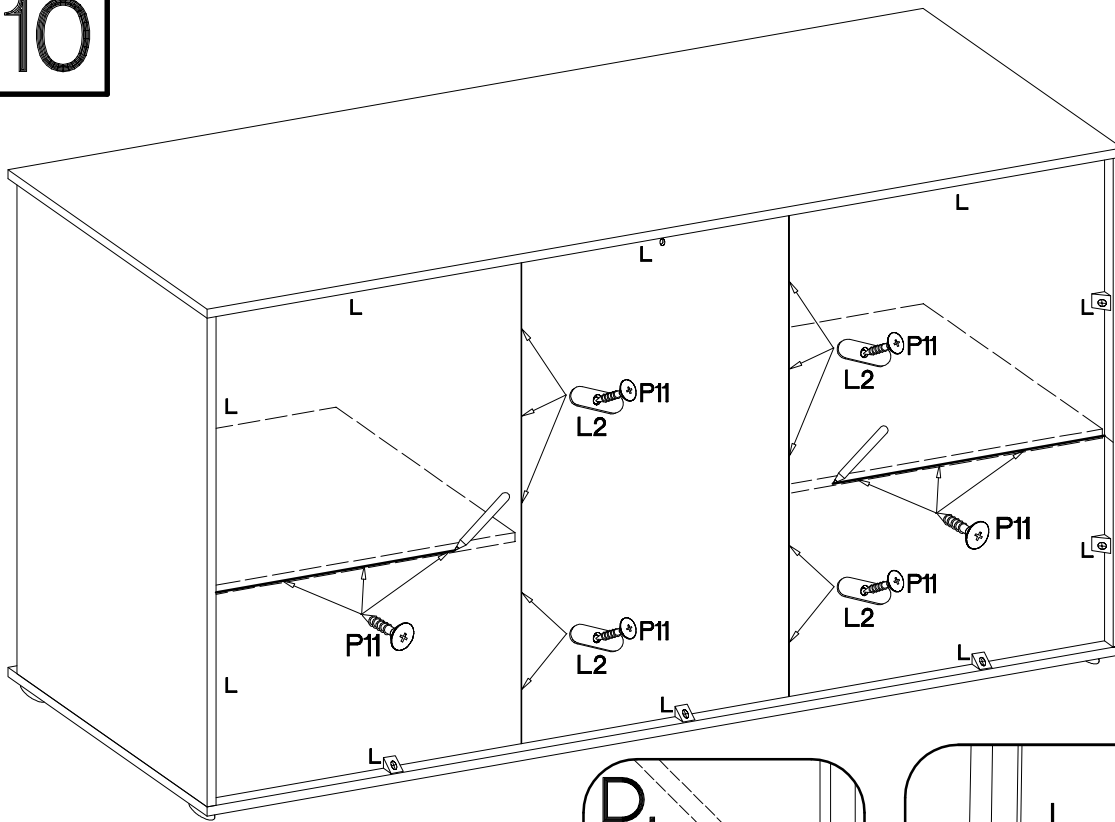

$\varnothing 3.0 \times 20 \text{mm}$		
P7	L2	L
16	10	10

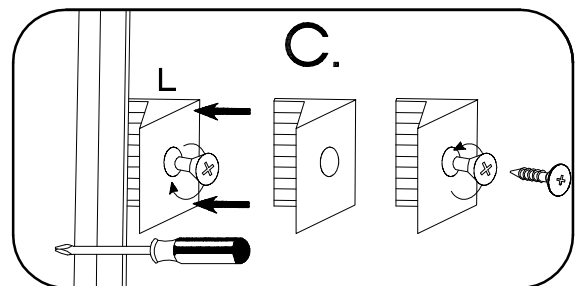
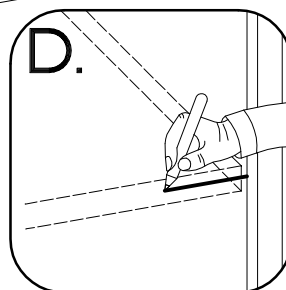
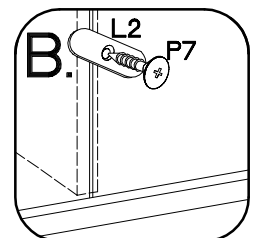
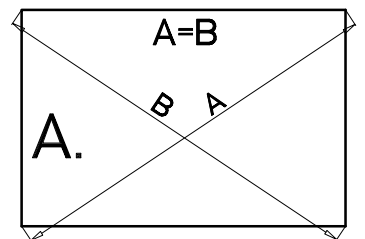

11

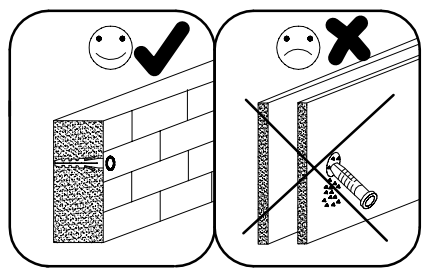
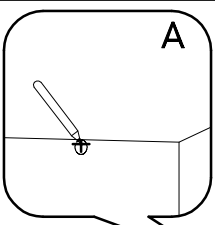

	$\pm 3.5 \times 13 \text{mm}$
L9	P5
1	1
$\pm 10 \times 50 \text{mm}$	
O7	
1	

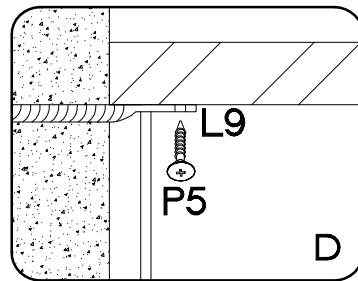
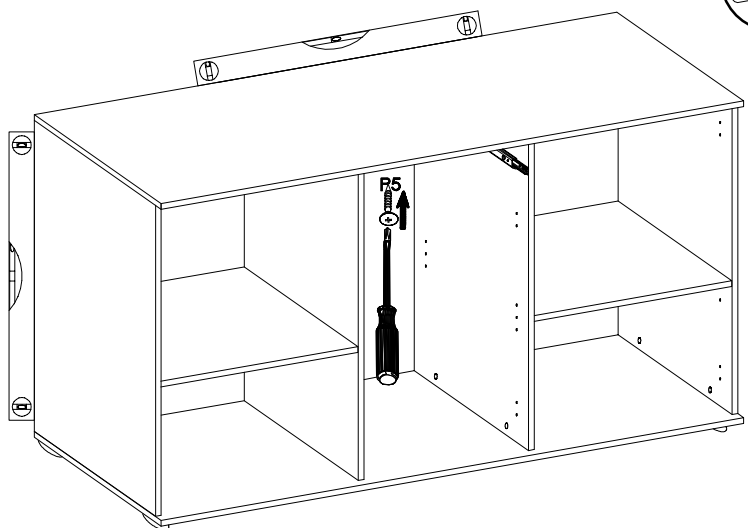
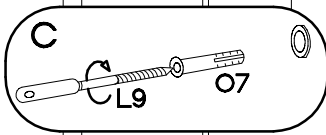
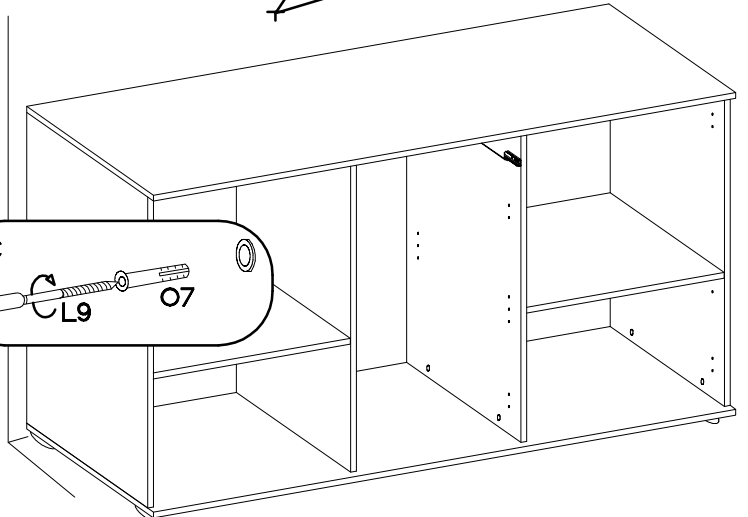
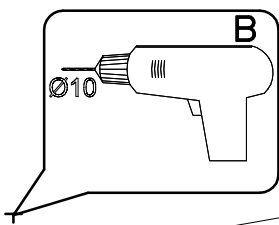
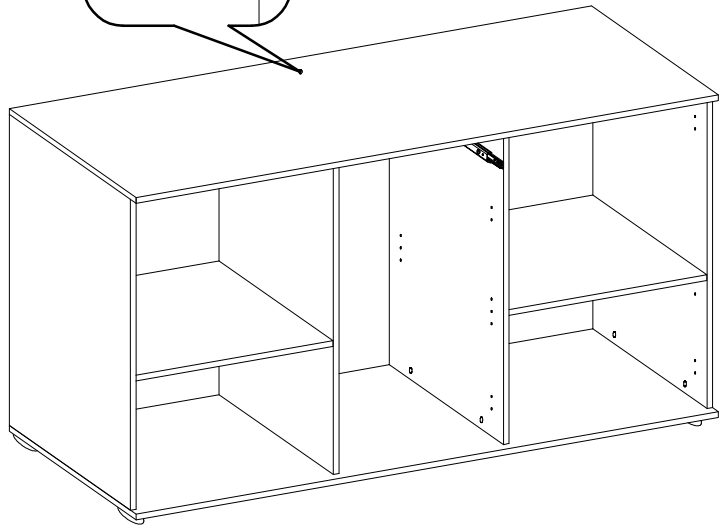

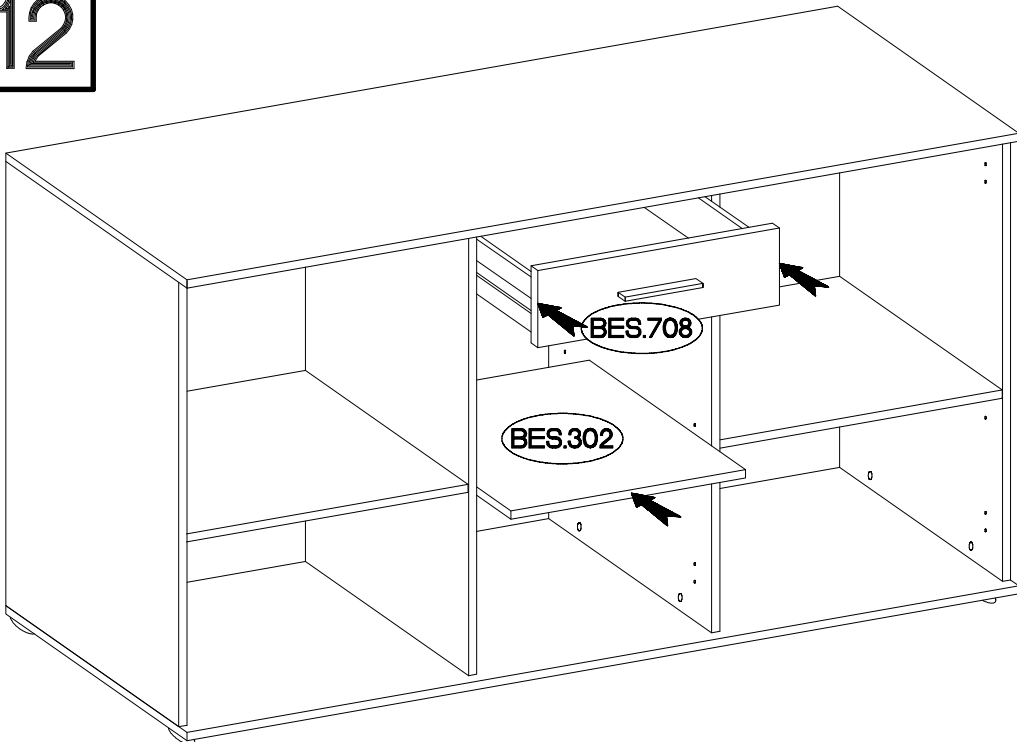

12

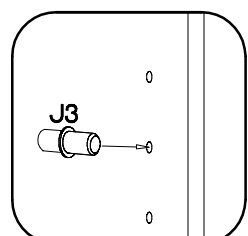
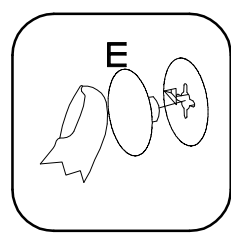
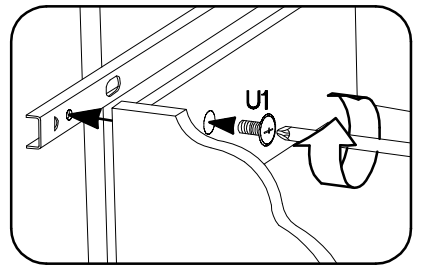

		$M4 \times 9 \text{mm}$
E	J3	U1
24	4	2

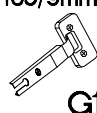
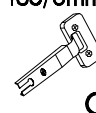
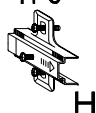

# 13

+35/9mm  G1 2	+35/0mm  G 6	H=0  H 8	+3.5x13mm  P5 16
--	---	---	---

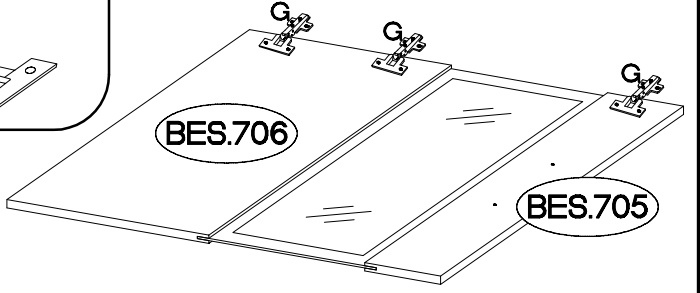
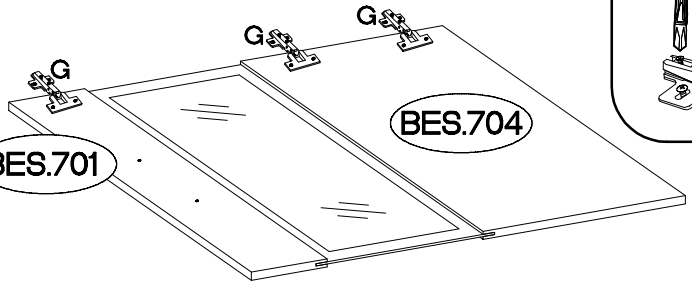
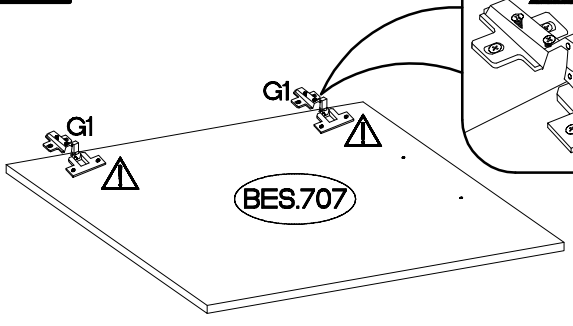
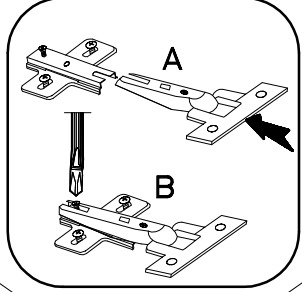
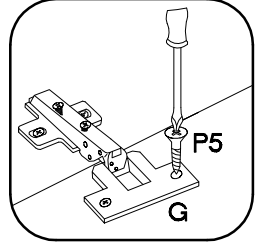
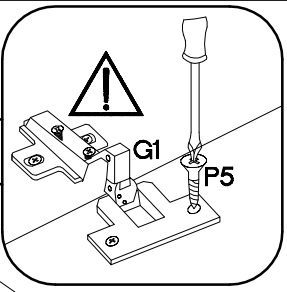

# 14

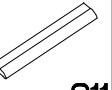
+4.0x30mm  R2 6	L=128mm  S11 3
---	--

