

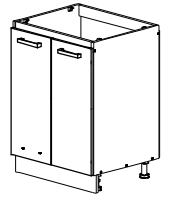

NOVA PLUS NOPL-057-0S

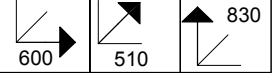

V PRÍPADE REKLAMÁCIE JE POTREBNÉ NAHLÁSIŤ
 VÝROBNÉ ČÍSLO VIDITEĽNÉ NA ETIKETE



22300,00 	27000,00 	21102,00 	50552,06 	32021,00 		35101,01 	22243,00 	36002,05 	36020,00
A 10x	B 8x	C 20x	D 4x	E 2x	F 10x	G 4x	H 8x	I 4x	J 4x
60025,05 	60035,00 	22244,01 	22224,01 						
K 4x	L 2x	M 8x	N 24x						

 0h 40min			 3m	 4		 ≤ 0,5 kg
--------------	--	--	--------	-------	--	--------------

ID	ID	Part	Qty	Ratio
00396	2	730*490*16	1x	1/1
00397	3	730*490*16	1x	1/1
00398	4	568*60*16	2x	1/1
00399	5	568*470*16	1x	1/1
00400	6	568*489*16	1x	1/1
00401	7	600*100*16	1x	1/1
00306	8	694*296*16	2x	1/1
00382	9	694*596*2,5	1x	1/1

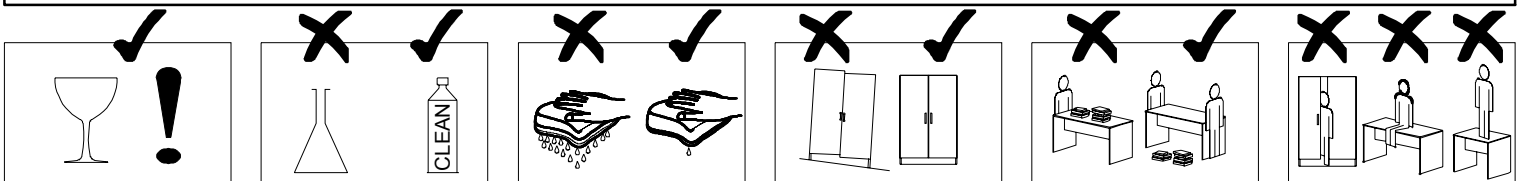
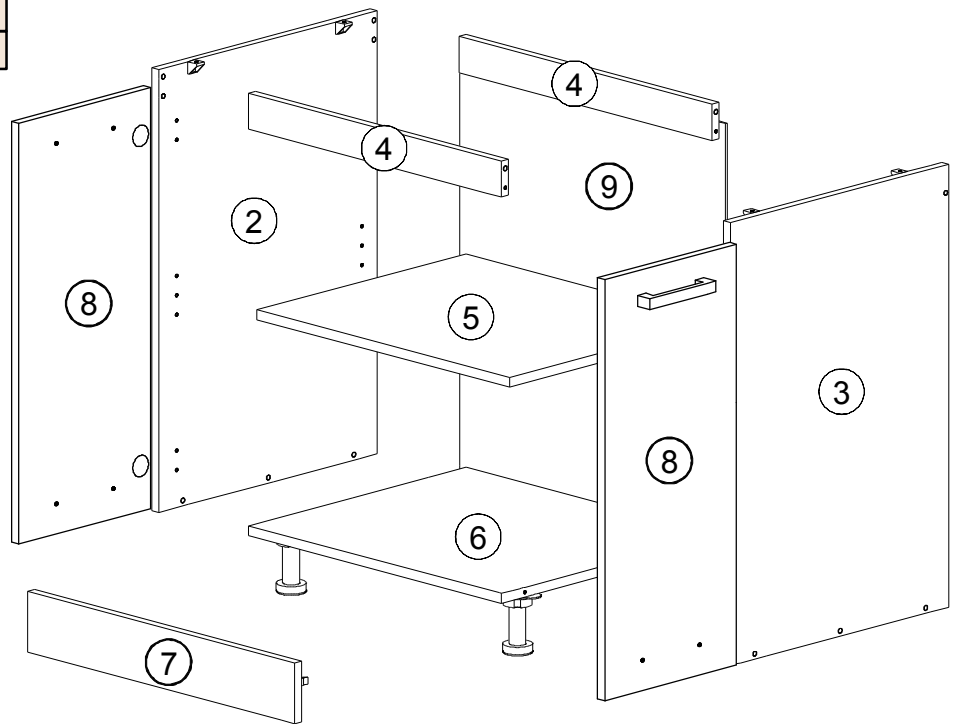

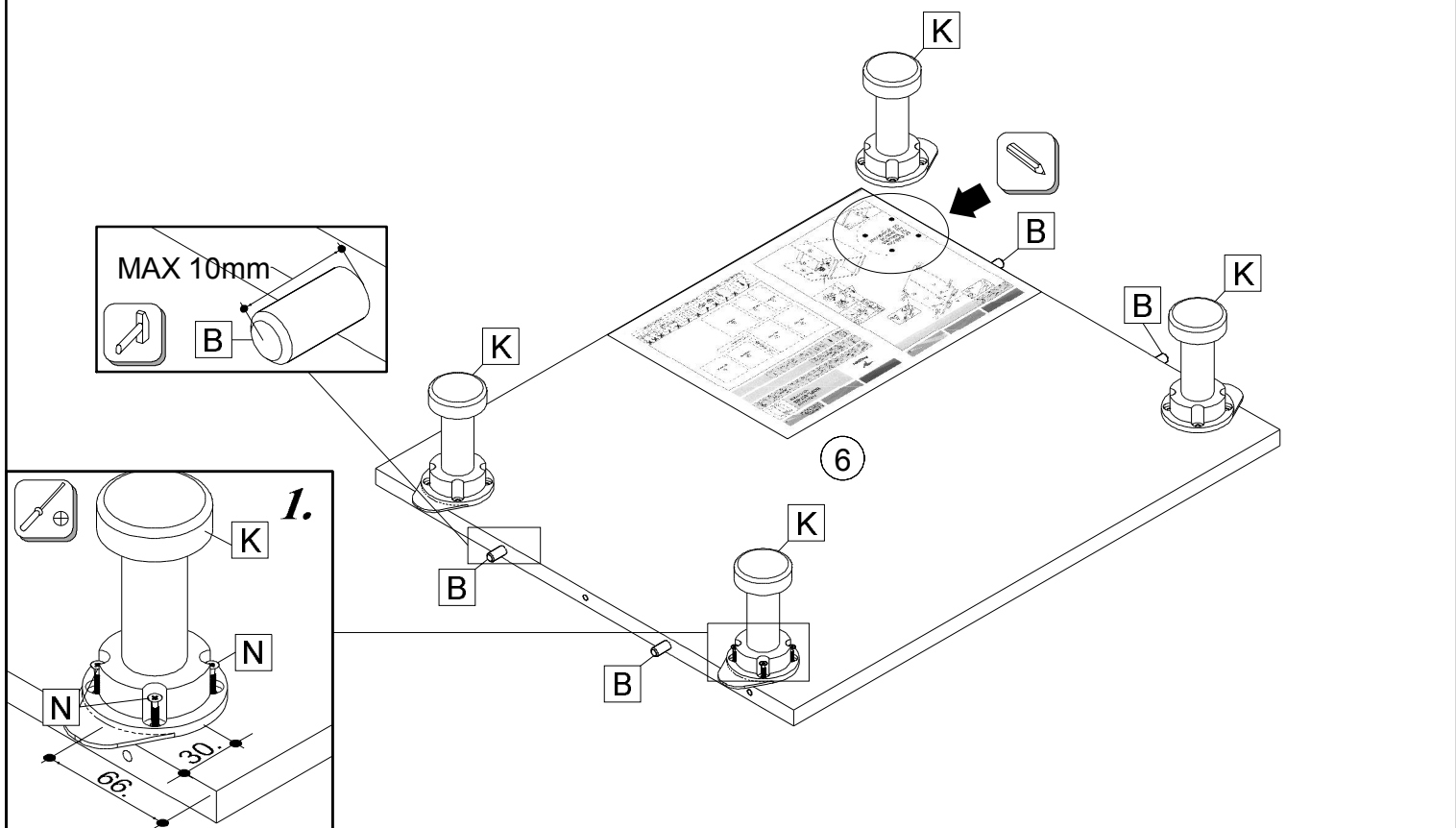

K 4x	Ø4x16 16x	Ø8x30 4x



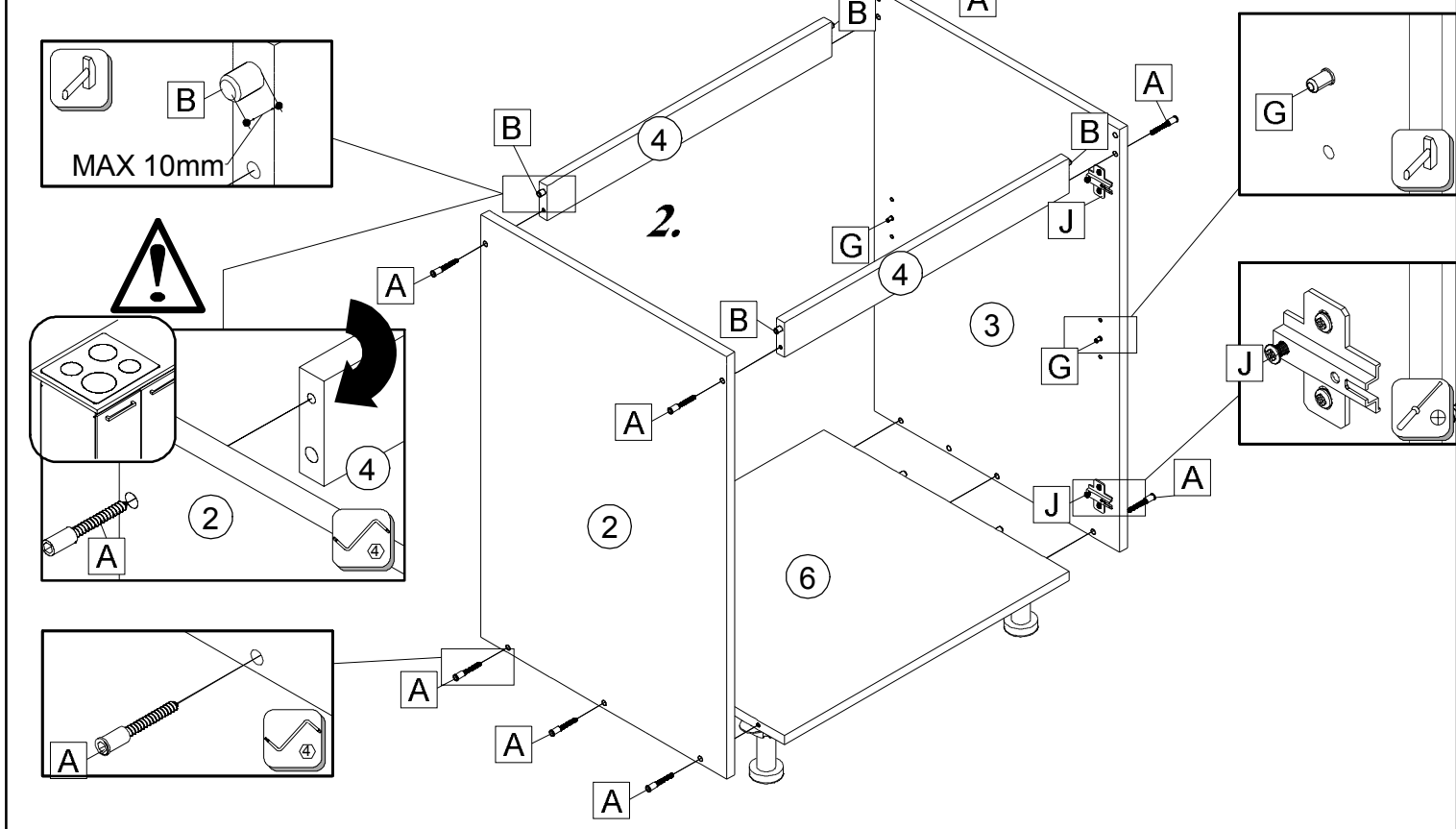



A 10x	Ø8x30 4x	G 4x	J 4x

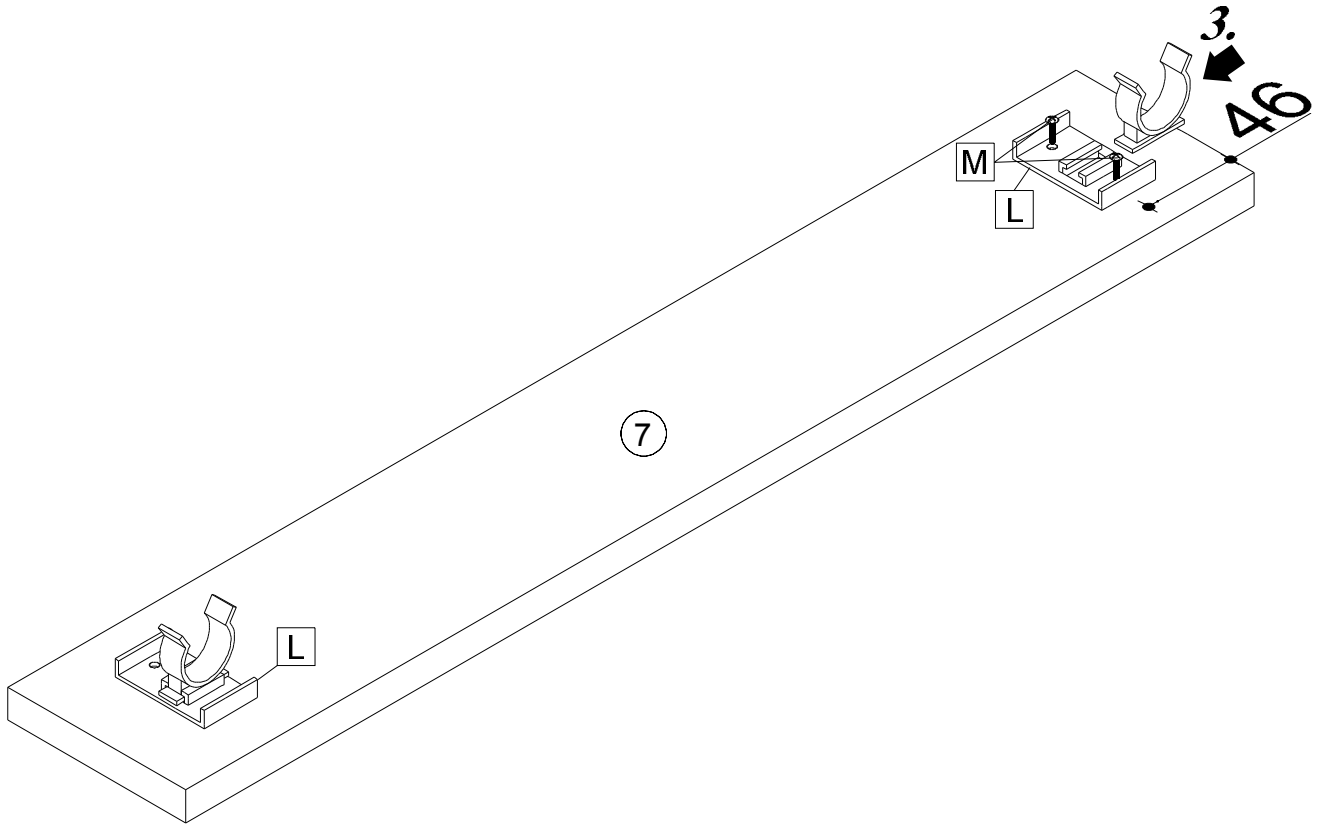



	
L 2x	M 4x

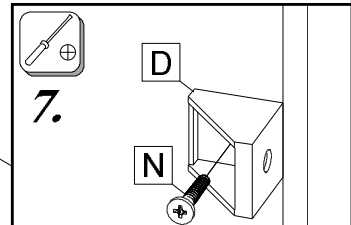
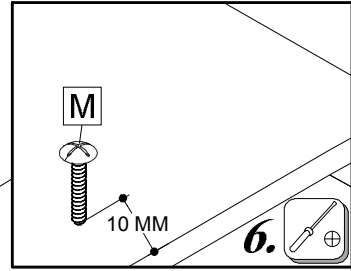
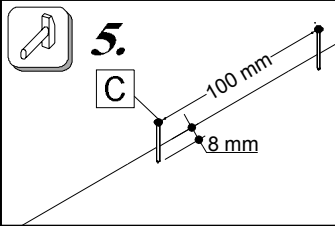
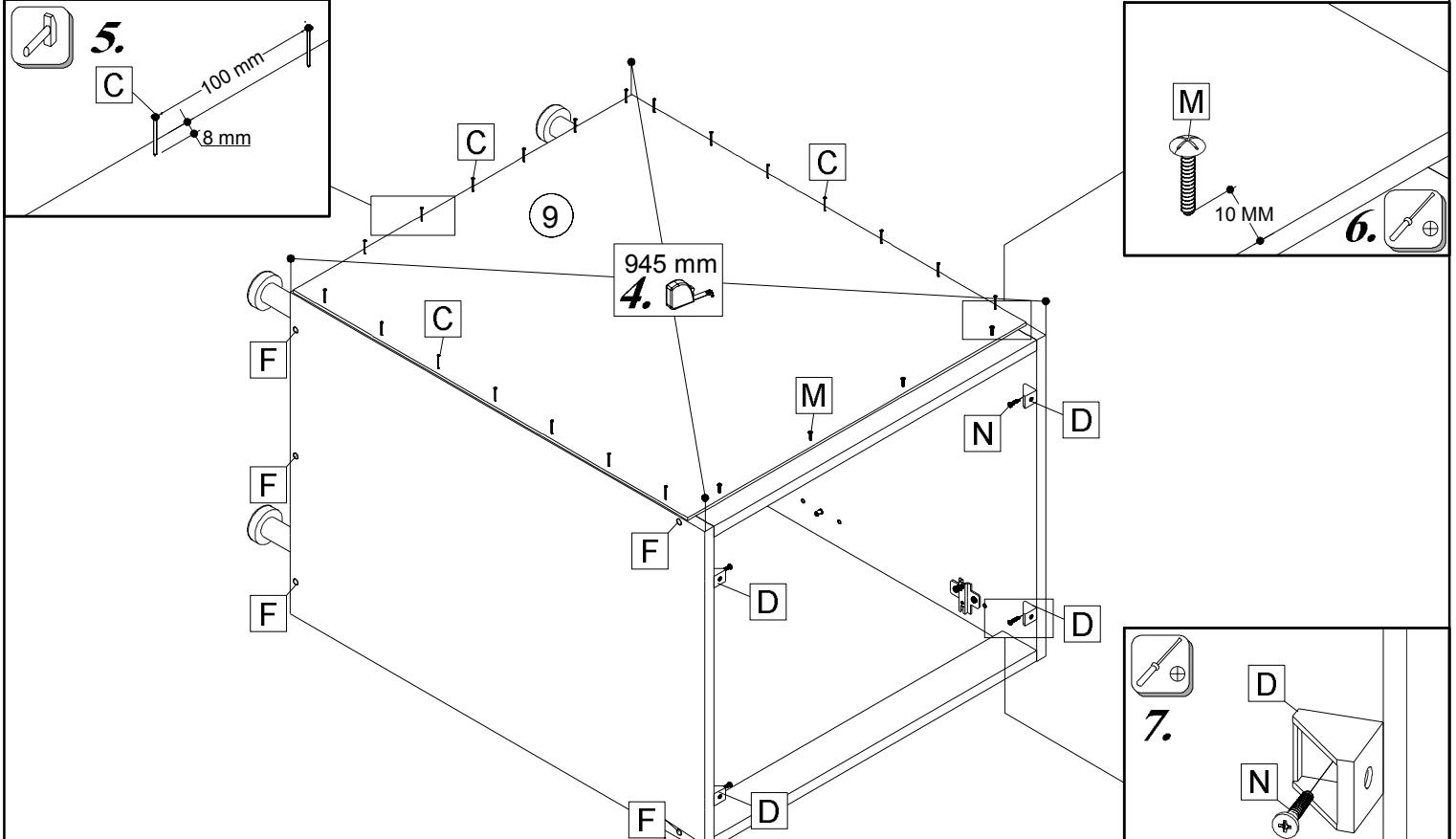

				
C 20x	D 4x	F 10x	M 4x	N 4x

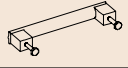

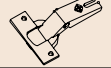
		
E 2x	H 8x	I 4x
Ø3,5x15		

