

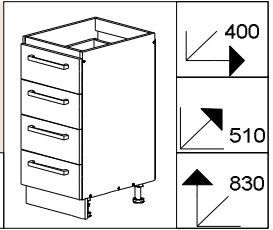

NOVA PLUS NOPL-055-0S



V PRÍPADE REKLAMÁCIE JE POTREBNÉ NAHLÁSIŤ
 VÝROBNÉ ČÍSLO VIDITEĽNÉ NA ETIKETE



A 26x	B 8x	C 20x	D 24x	E 4x	F 10x	Ga 4x Gb 4x	H 32x	J 16x	K 16x



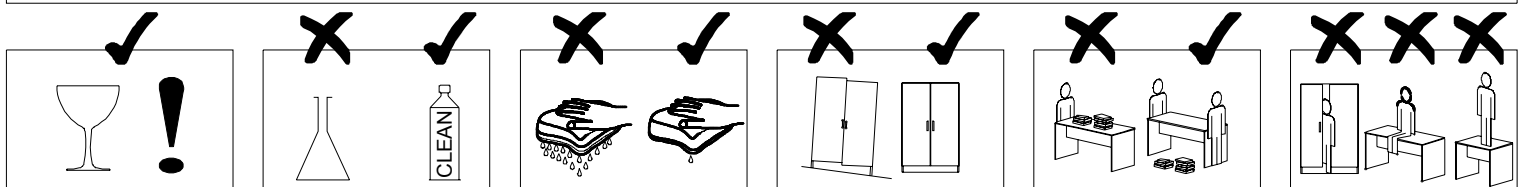
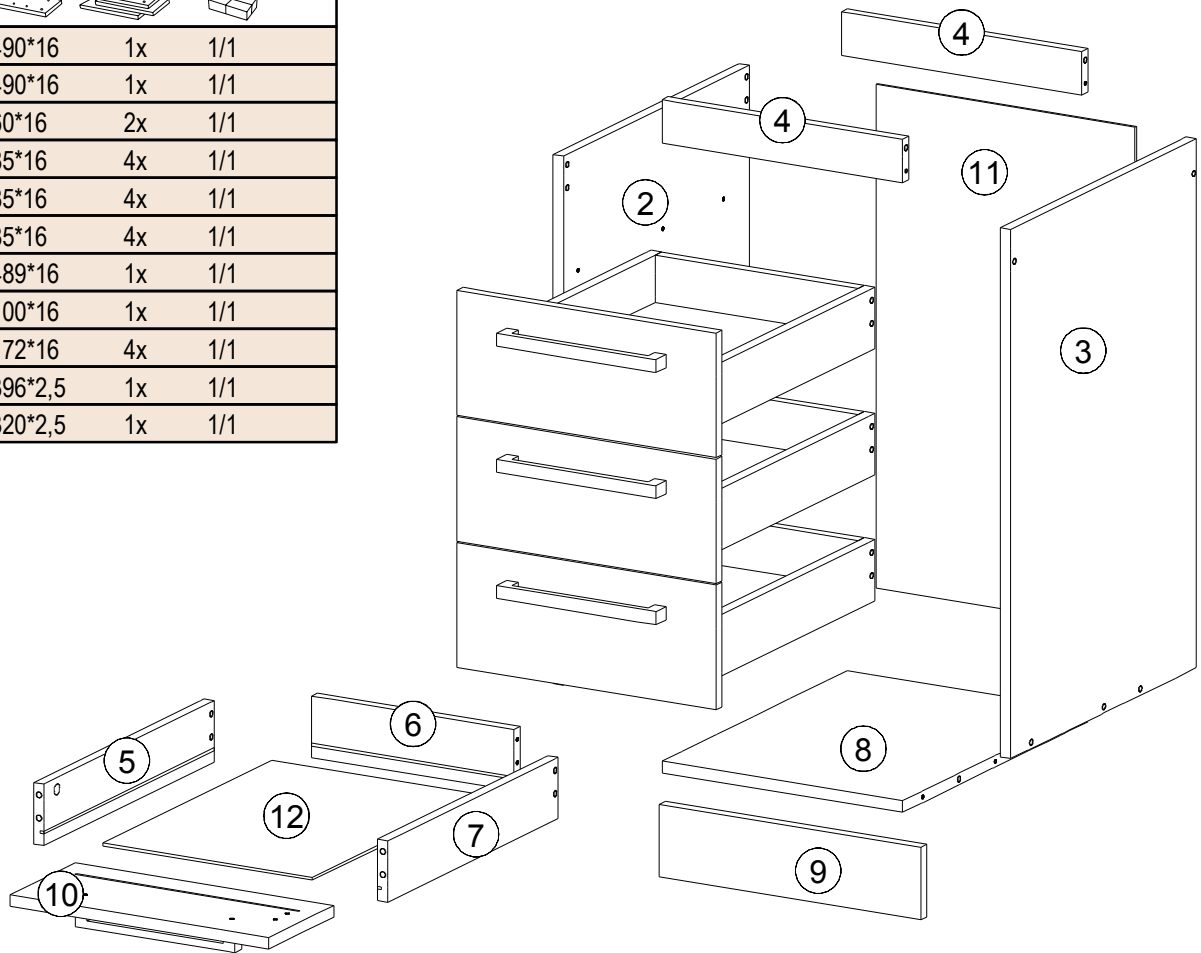

L 2x	M 4x	N 8x	P 24x	R 4x

0h 55min			3m	4		≤ 0,5 kg

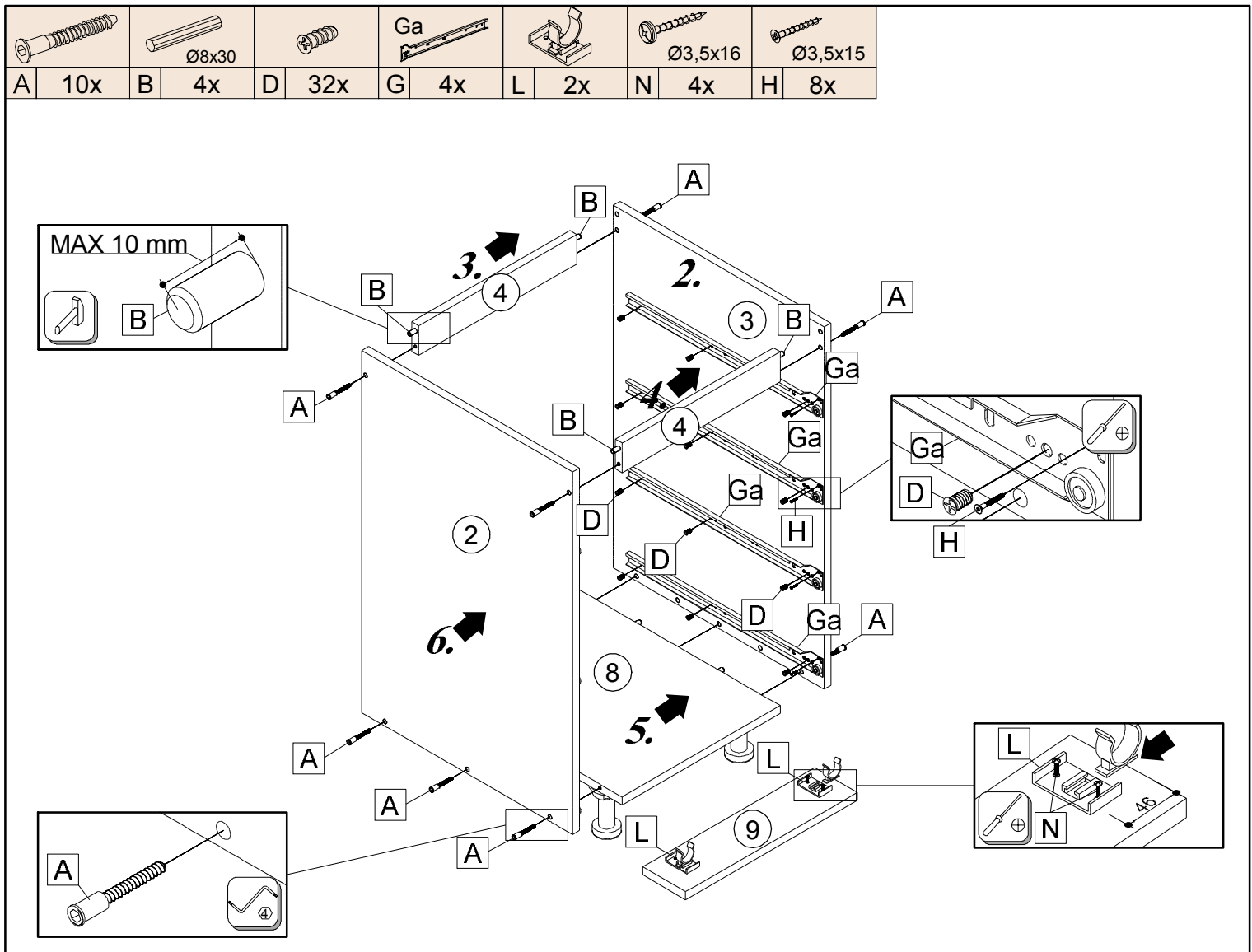
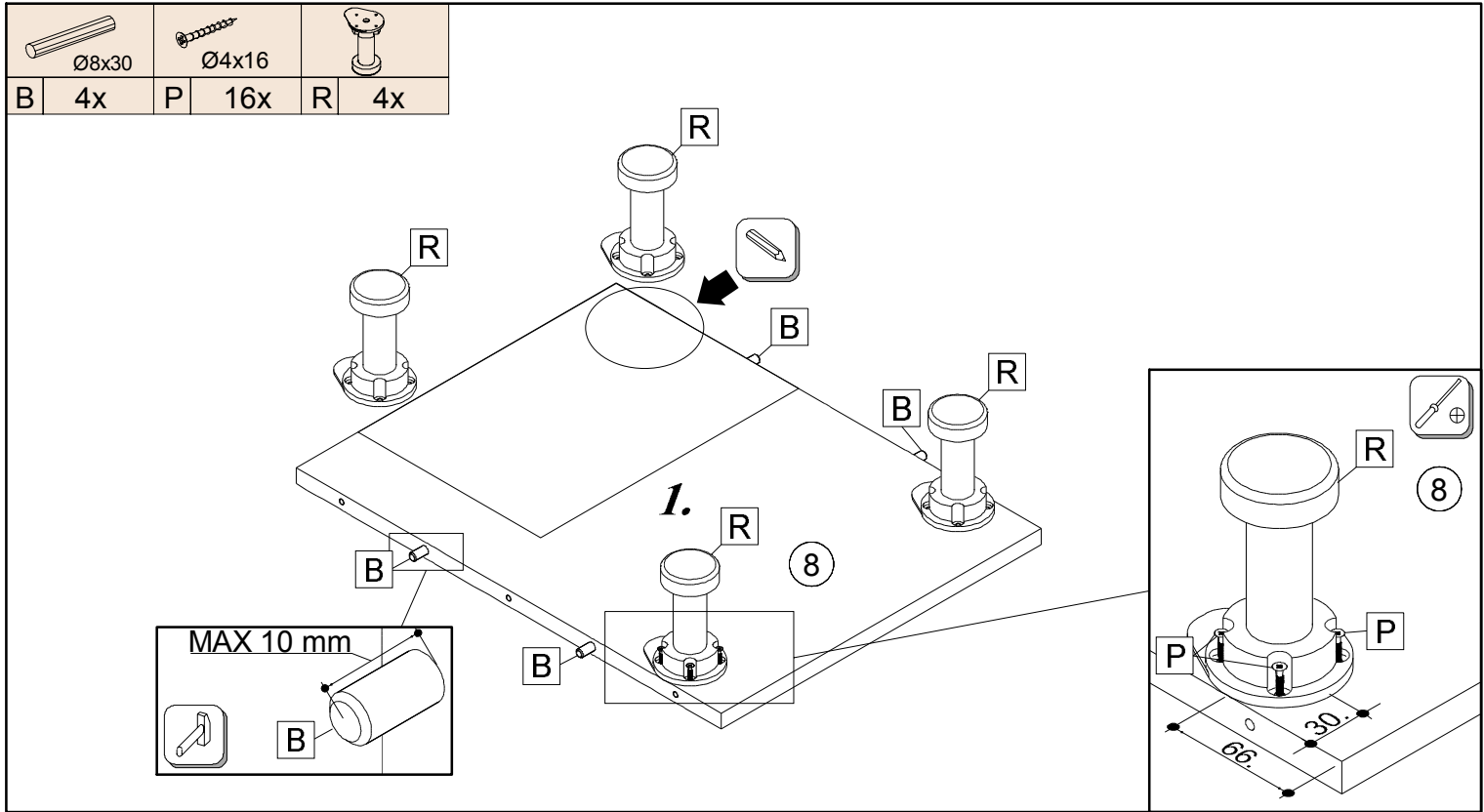

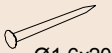

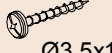
ID	ID	Part	QTY	Ratio
00360	②	730*490*16	1x	1/1
00361	③	730*490*16	1x	1/1
00354	④	368*60*16	2x	1/1
00362	⑤	450*85*16	4x	1/1
00363	⑥	310*85*16	4x	1/1
00364	⑦	450*85*16	4x	1/1
00356	⑧	368*489*16	1x	1/1
00357	⑨	400*100*16	1x	1/1
00365	⑩	396*172*16	4x	1/1
00857	⑪	694*396*2,5	1x	1/1
00366	⑫	446*320*2,5	1x	1/1



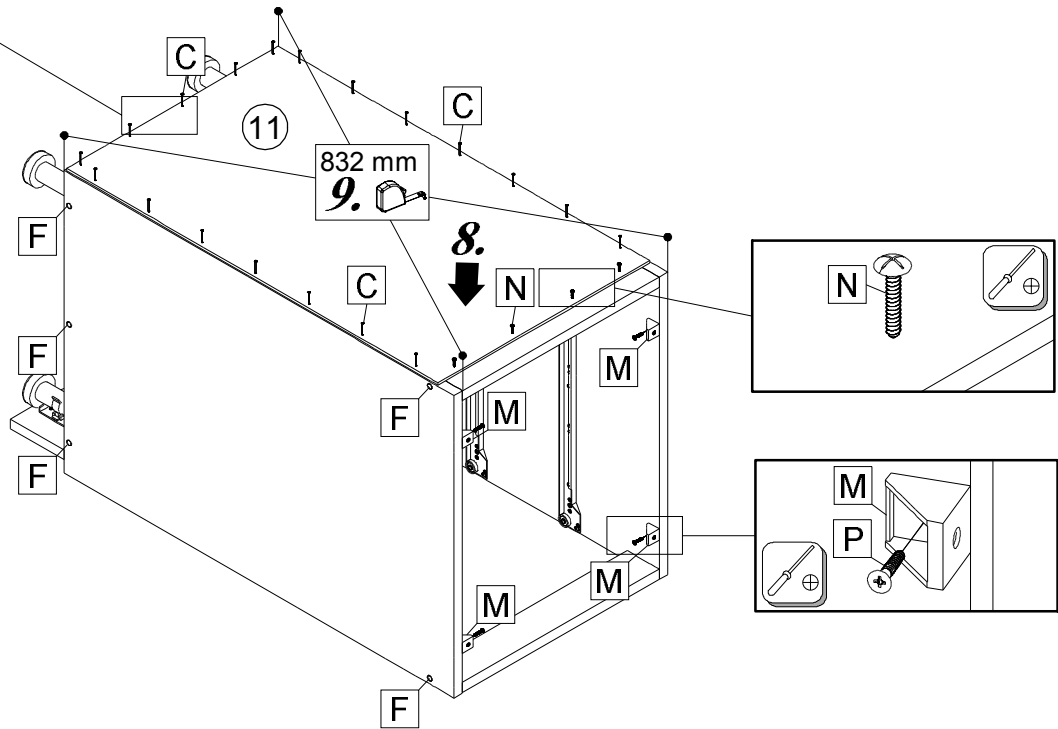
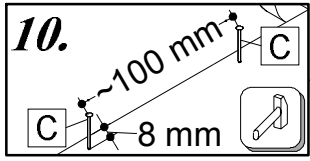

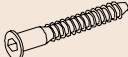
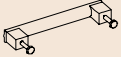
				
Ø1,6x20			Ø3,5x16	Ø4x16
C 20x	F 10x	M 4x	N 4x	P 4x

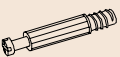

					
A 16x	E 4x	Gb 4x	Ø3,5x15	J 16x	K 16x

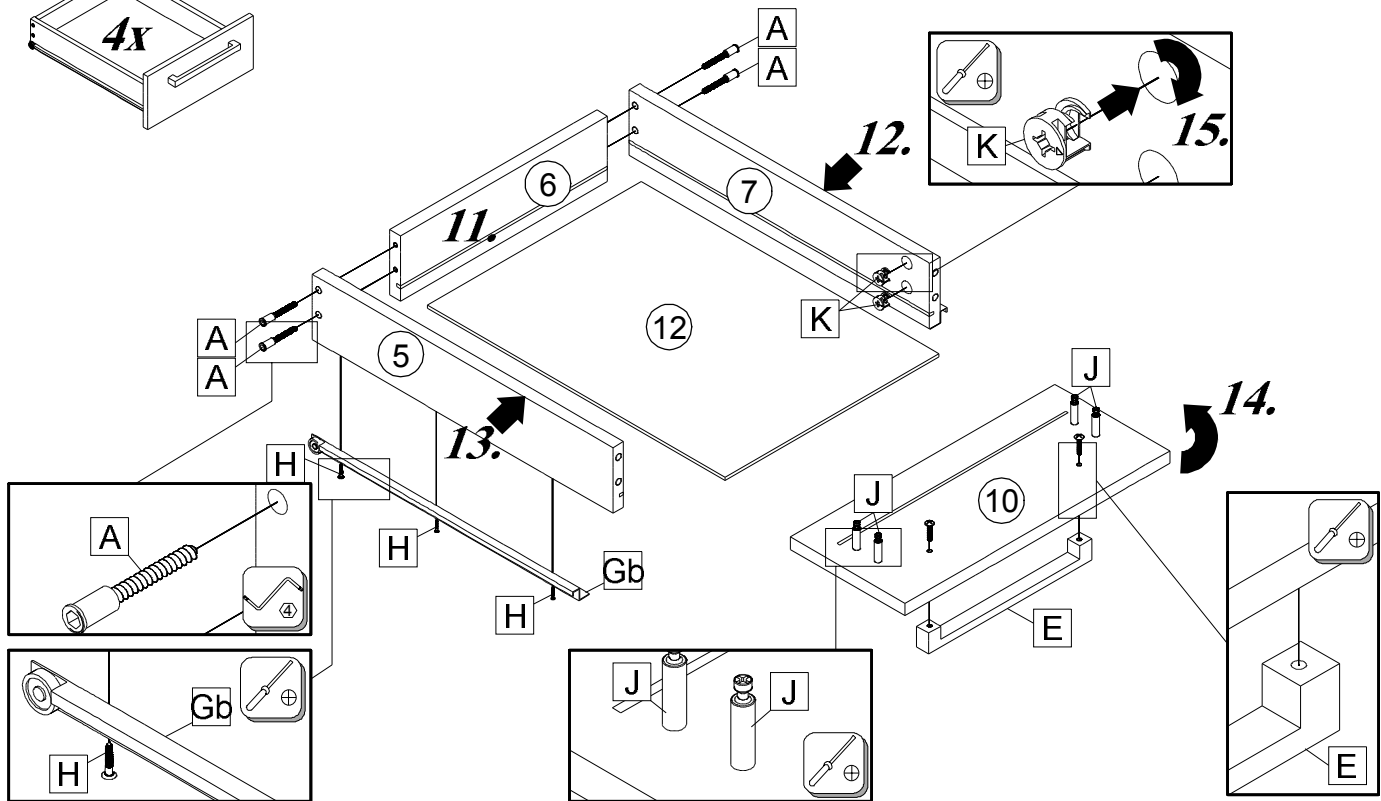
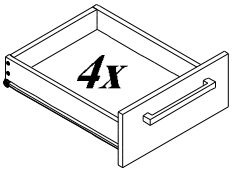

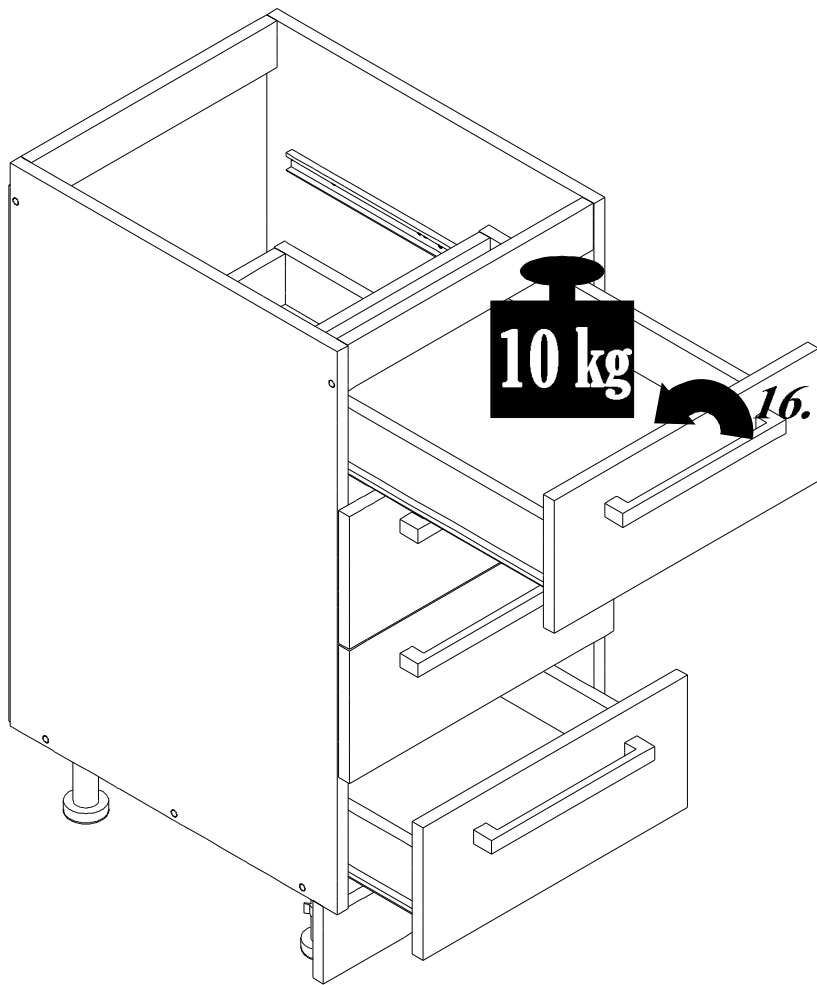

SK ŠABLÓNA
 CZ ŠABLONA
 HU SABLON
 DE SCHABLONE

