

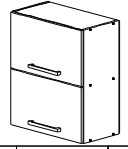

# NOVA PLUS NOPL-015-VH

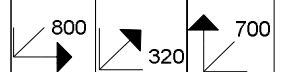

V PRÍPADE REKLAMÁCIE JE POTREBNÉ NAHLÁSIŤ  
 VÝROBNÉ ČÍSLO VIDITEĽNÉ NA ETIKETE





22300,00		Ø7x50	12x	21100,00		Ø1,6x20	25x	32021,00		2x	36002,07		2x	36002,07		4x	36013,02		2x	22243,00		Ø3,5x15	12x	24101,00		Ø10	2x	31000,01		2x
----------	--	-------	-----	----------	--	---------	-----	----------	--	----	----------	--	----	----------	--	----	----------	--	----	----------	--	---------	-----	----------	--	-----	----	----------	--	----

22206,00		Ø5x60	2x	70603,00		4x	70603,00		4x	70603,00		60N L=247	4x	70603,00		Ø3,5x15	12x	22236,00		Ø2,5x16	8x	22244,01		Ø3,5x16	4x	24008,00		Ø	8x
----------	--	-------	----	----------	--	----	----------	--	----	----------	--	-----------	----	----------	--	---------	-----	----------	--	---------	----	----------	--	---------	----	----------	--	---	----

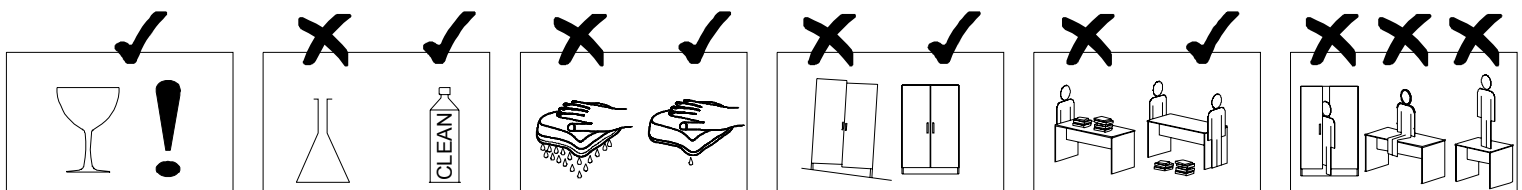
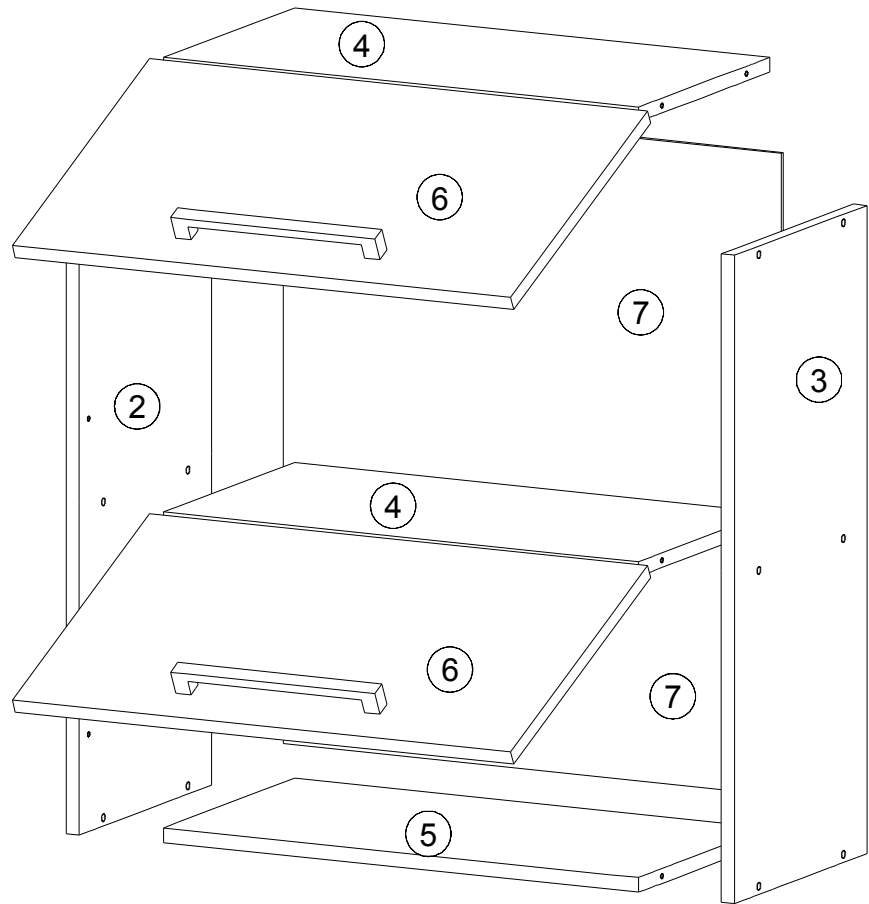

	0h 45min		4		±		≤ 0,5 kg		2		3m		2		Ø10mm
--	----------	--	---	--	---	--	----------	--	---	--	----	--	---	--	-------

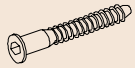
ID	D	Part	QTY	UNIT
00325	2	700*300*16	1x	1/1
00903	3	700*300*16	1x	1/1
00340	4	768*299*16	2x	1/1
00341	5	768*299*16	1x	1/1
00342	6	344*796*16	2x	1/1
00343	7	345*796*2,5	2x	1/1



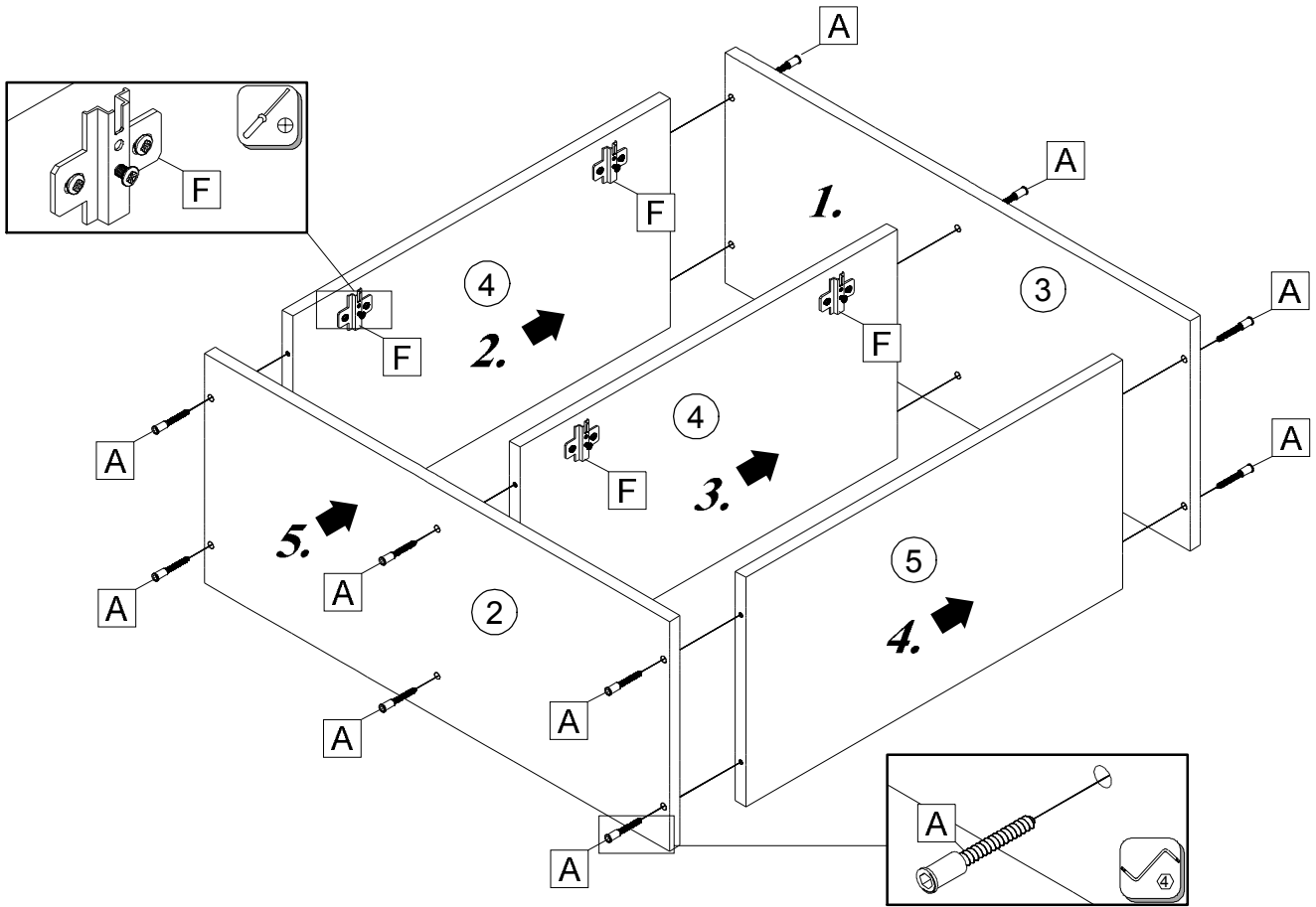

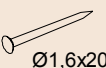
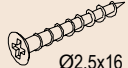

			
A	12x	F	4x

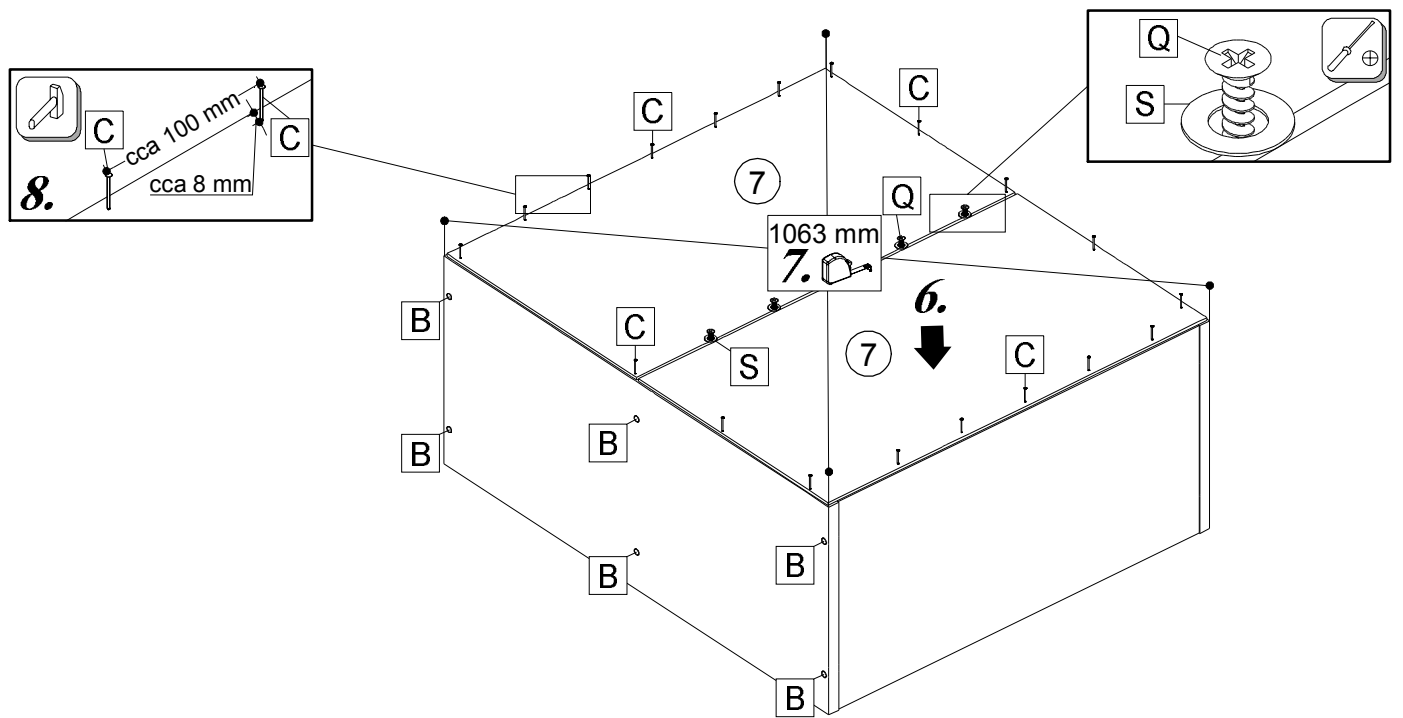

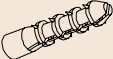



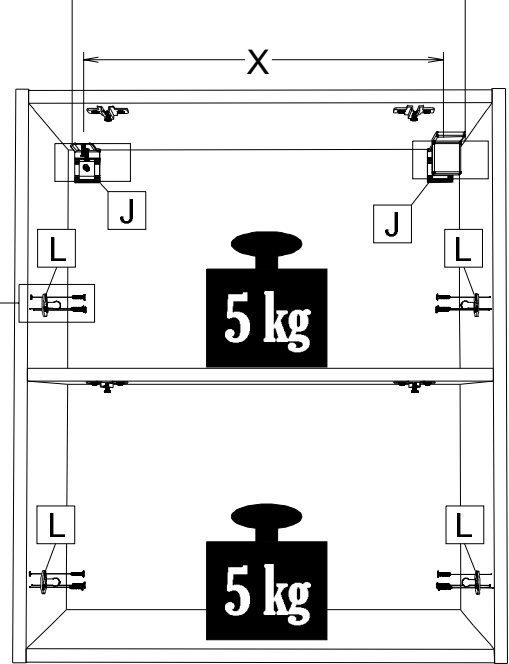
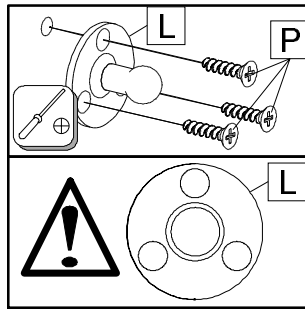
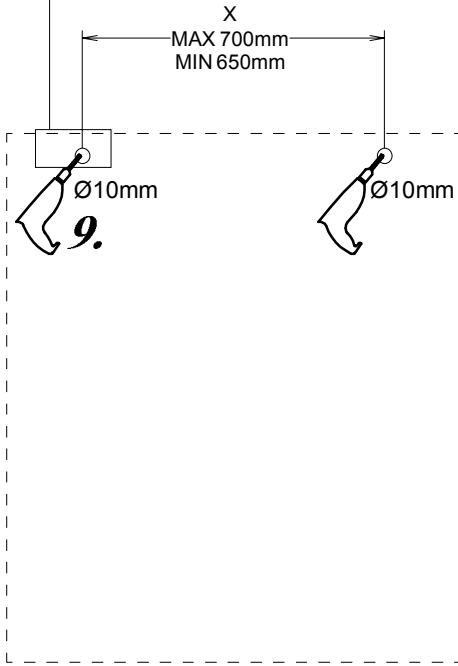
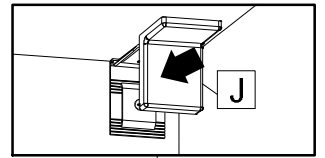
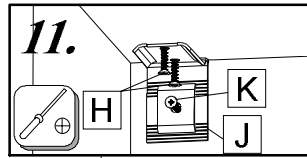
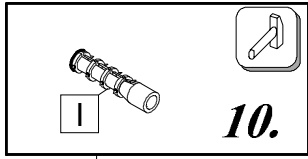

							
B	12x	C	25x	Q	8x	S	8x

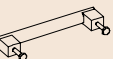

					
Ø3,5x15			Ø5x60		Ø3,5x15
H 4x	I 2x	J 2x	K 2x	L 4x	P 12x



					
			Ø3,5x15		Ø3,5x16
D 2x	E 2x	G 2x	H 8x	M 4x	R 8x

