

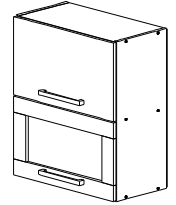

NOVA PLUS NOPL-009-VH

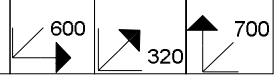

V PRÍPADE REKLAMÁCIE JE POTREBNÉ NAHLÁSIŤ
 VÝROBNÉ ČÍSLO VIDITEĽNÉ NA ETIKETE





22300,00 Ø7x50		21102,00 Ø1,6x20		32315,00		36002,07		36002,07		36013,02		22243,00 Ø3,5x15		24101,00 Ø10		31000,01			
A	12x	B	12x	C	25x	D	2x	E	2x	F	4x	G	2x	H	12x	I	2x	J	2x

22226,00 Ø5x60		70603,00		70603,00		70603,00		60N L=247		70603,00		Ø3,5x15	22236,00		Ø2,5x16	22244,01		Ø3,5x16	24008,00		
K	2x	L	2x	M	2x	N	2x	P	6x	Q	6x	R	4x	S	6x						

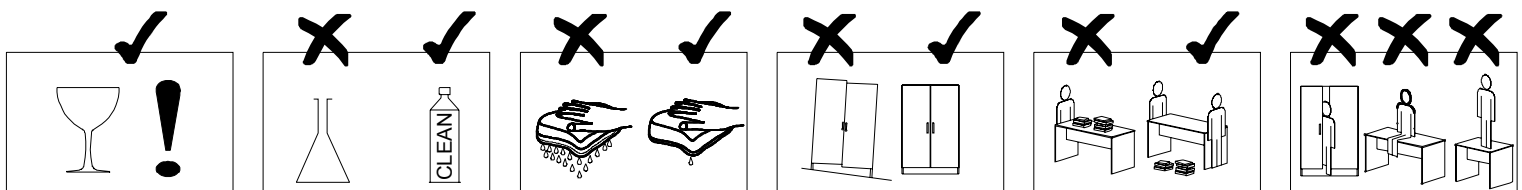
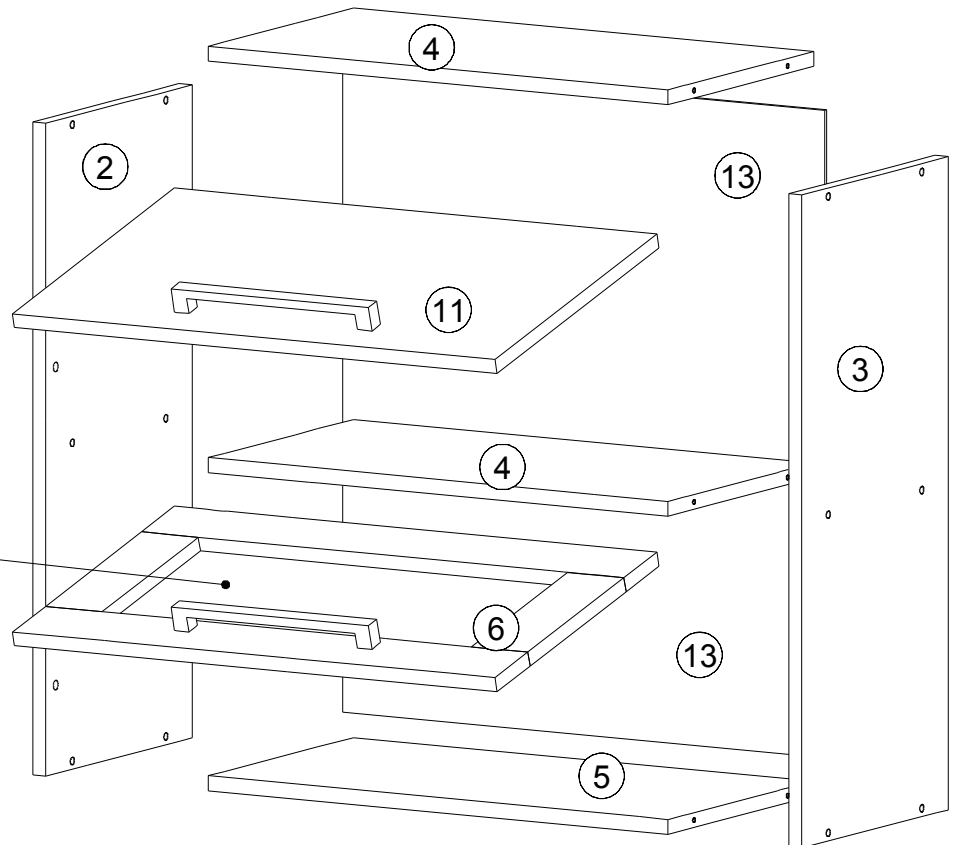

	0h 45min		4				≤ 0,5 kg				3m				Ø10mm
--	----------	--	---	--	--	--	----------	--	--	--	----	--	--	--	-------

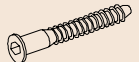
ID	D	Icon	Dimensions	Qty	Unit
00325	2		700*300*16	1x	1/2
00326	3		700*300*16	1x	1/2
00327	4		568*299*16	2x	1/2
00328	5		568*299*16	1x	1/2
	6		596*344*20	1x	2/2
00329	11		344*596*16	1x	1/2
00330	13		345*596*2,5	2x	1/2



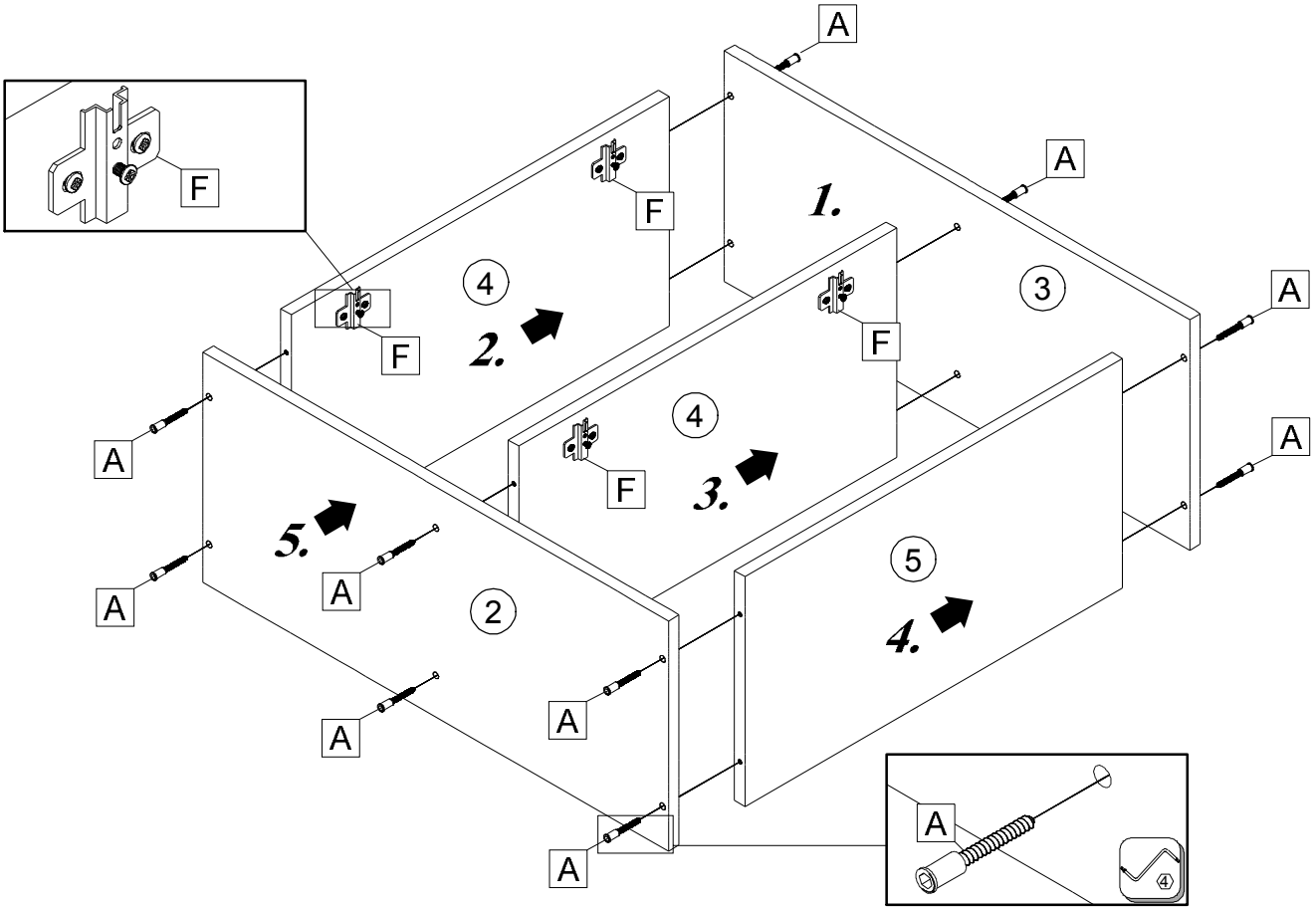

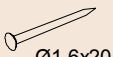
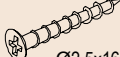

			
A	12x	F	4x

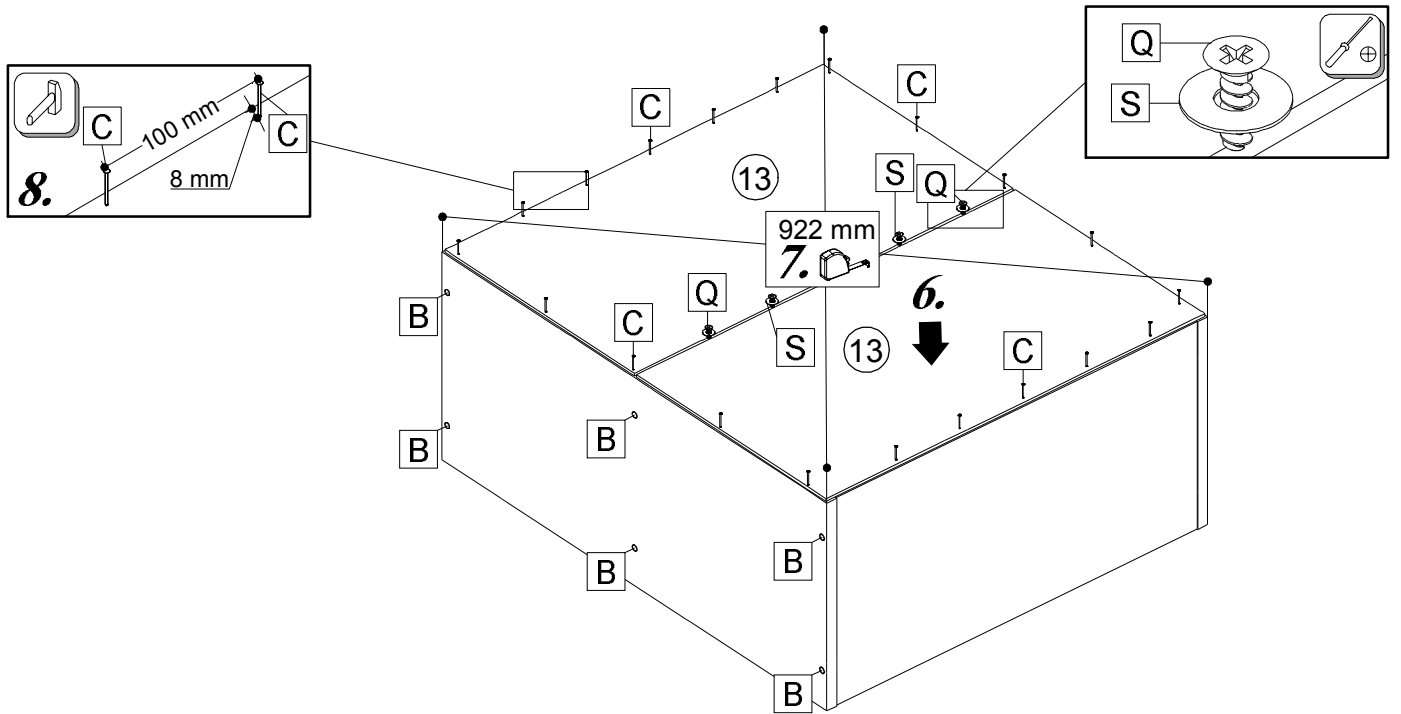

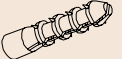



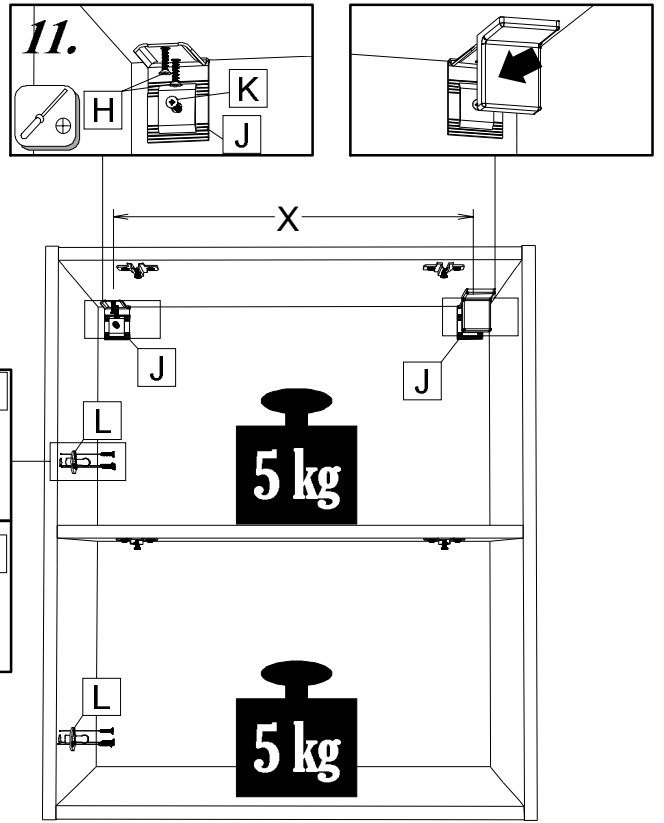
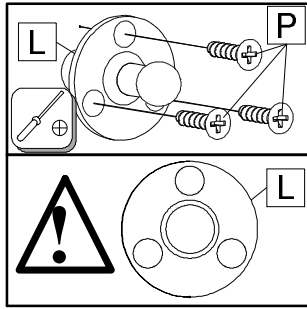
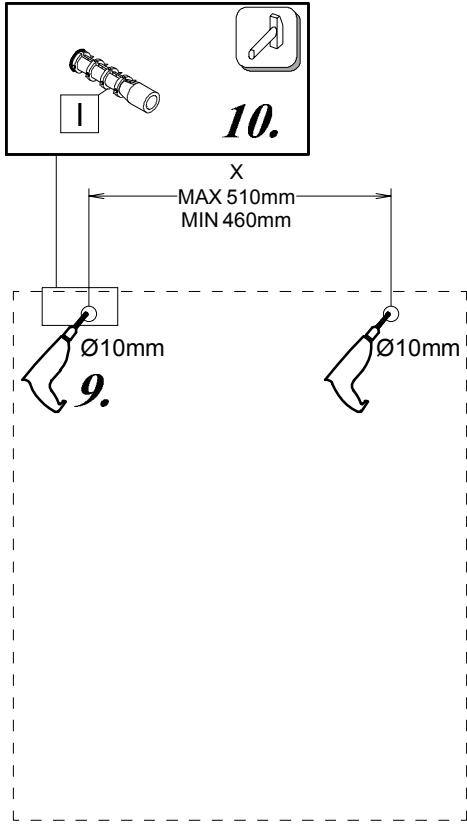

							
B	12x	C	25x	Q	6x	S	6x

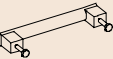

					
Ø3,5x15			Ø5x60		Ø3,5x15
H 4x	I 2x	J 2x	K 2x	L 2x	P 6x



					
			Ø3,5x15		Ø3,5x16
D 2x	E 2x	G 2x	H 8x	M 2x	R 4x

