

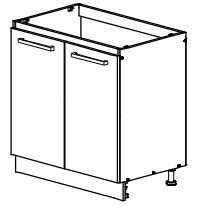

NOVA PLUS NOPL-060-0S

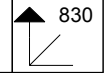

V PRÍPADE REKLAMÁCIE JE POTREBNÉ NAHLÁSIŤ
 VÝROBNÉ ČÍSLO VIDITEĽNÉ NA ETIKETE





22300,00 	27000,00 	21102,00 	50552,00 	32021,00 		35101,01 	22243,00 	36002,07 	36002,07 	
A 10x	B 8x	C 20x	D 4x	E 2x	F 10x	G 4x	H 8x	I 4x	J 4x	
60025,05 	60035,00 	22244,01 	22224,01 							
K 4x	L 2x	M 8x	N 24x							

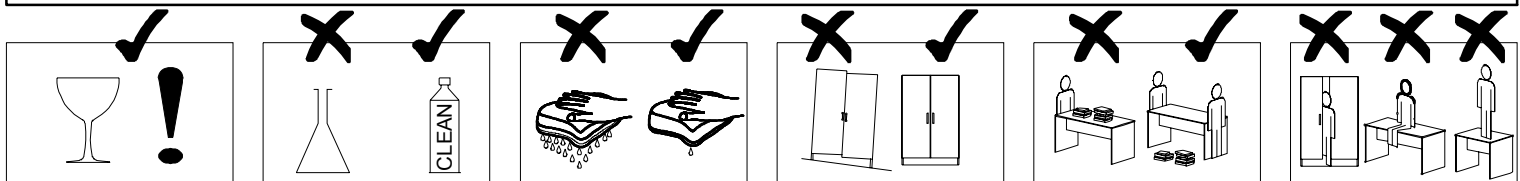
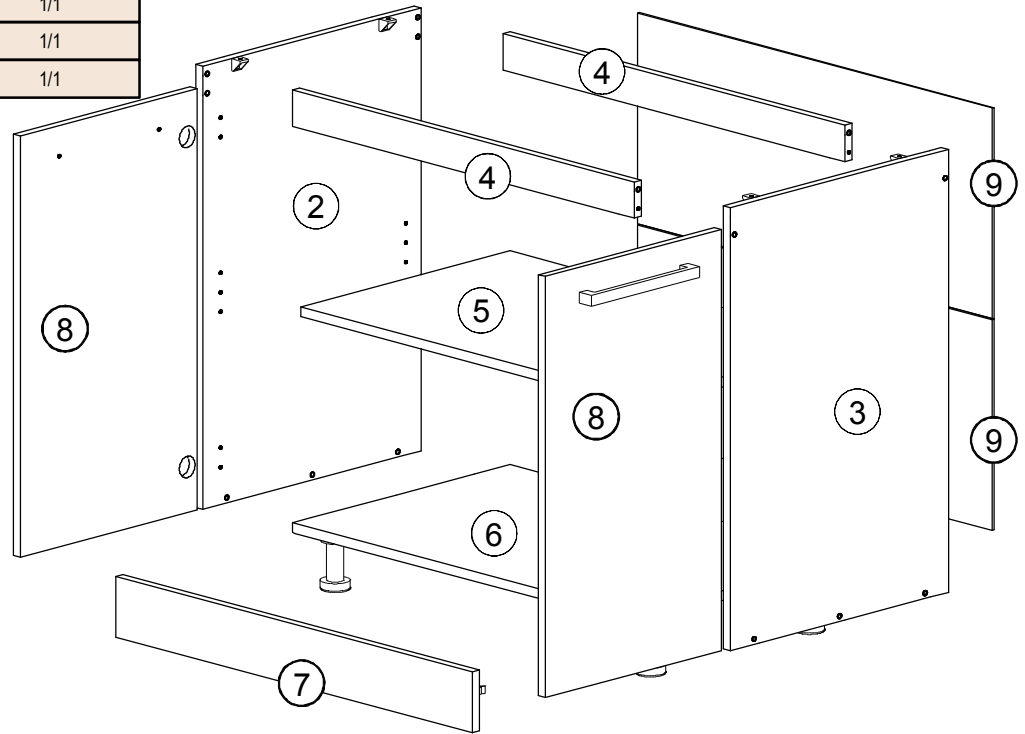

3m	4	PZ 2	≤ 0,5 kg	0h 45min		
----	---	------	----------	----------	--	--

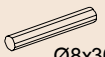
ID	ID			
00384	②	730*490*16	1x	1/1
00385	③	730*490*16	1x	1/1
00386	④	768*60*16	2x	1/1
00387	⑤	768*470*16	1x	1/1
00388	⑥	768*489*16	1x	1/1
00389	⑦	800*100*16	1x	1/1
00358	⑧	694*396*16	2x	1/1
00343	⑨	346*796*2,5	2x	1/1



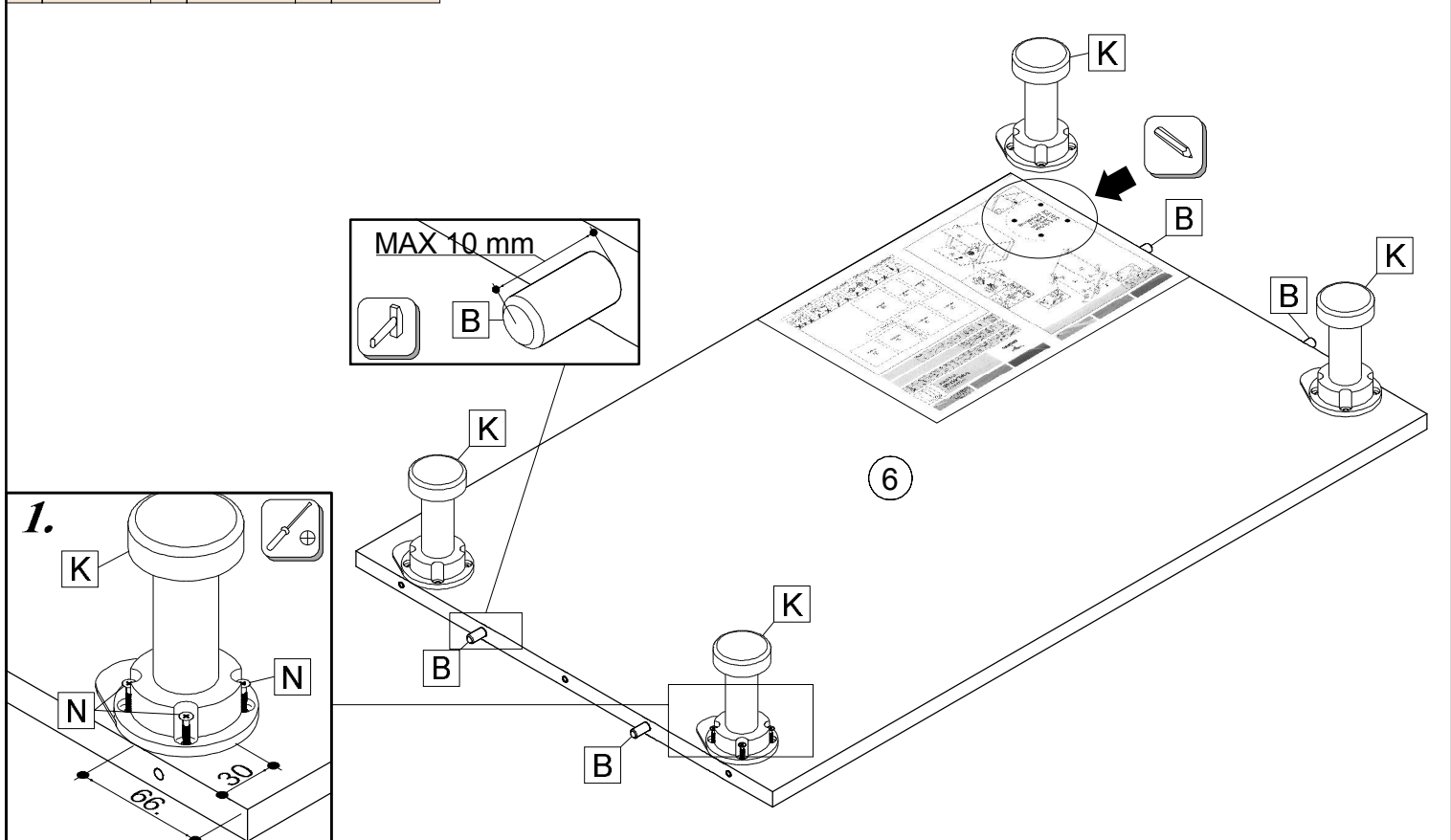

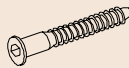
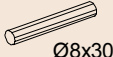
		
Ø8x30		Ø4x16
B 4x	K 4x	N 16x



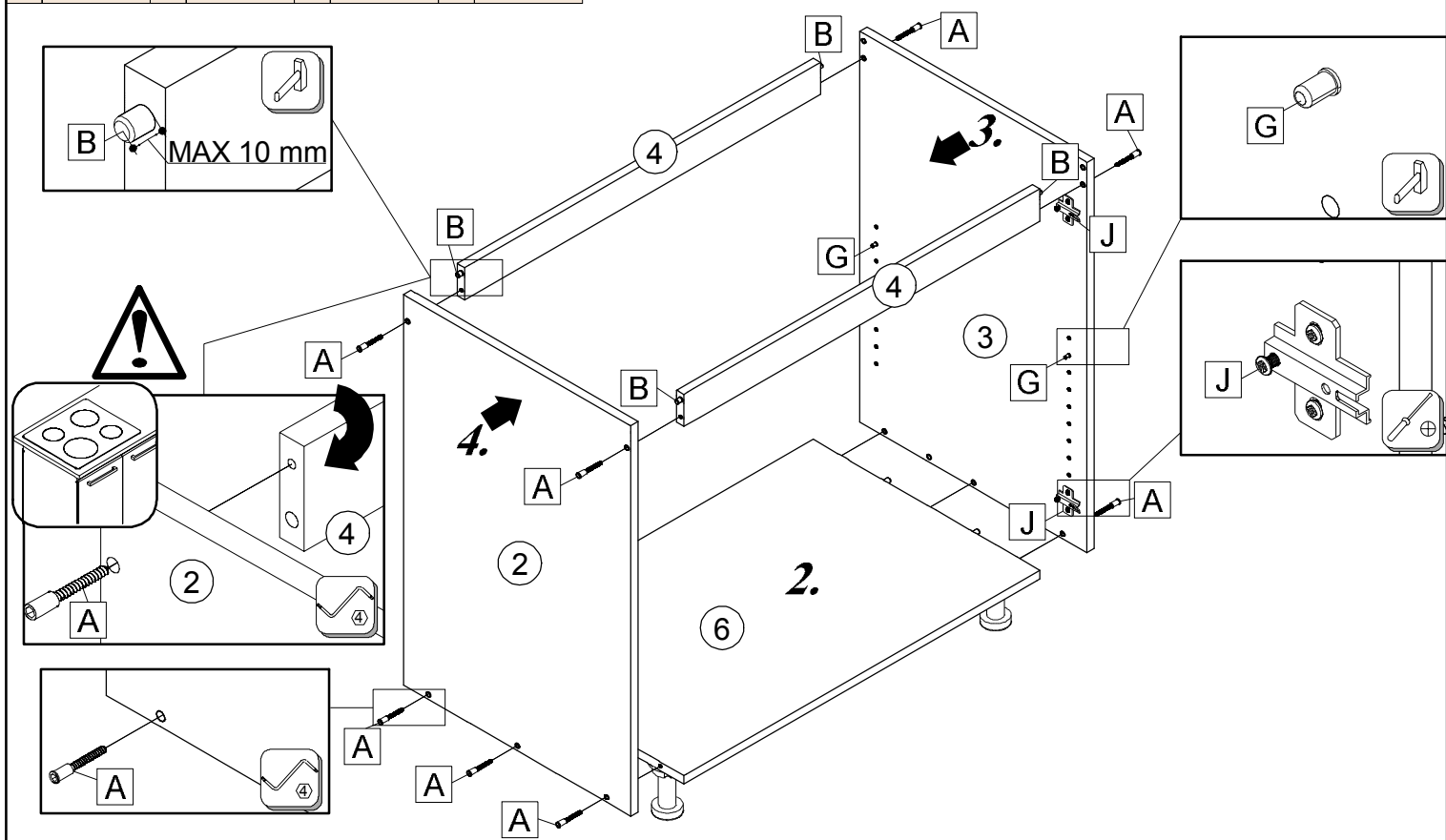



			
A 10x	Ø8x30	G 4x	J 4x

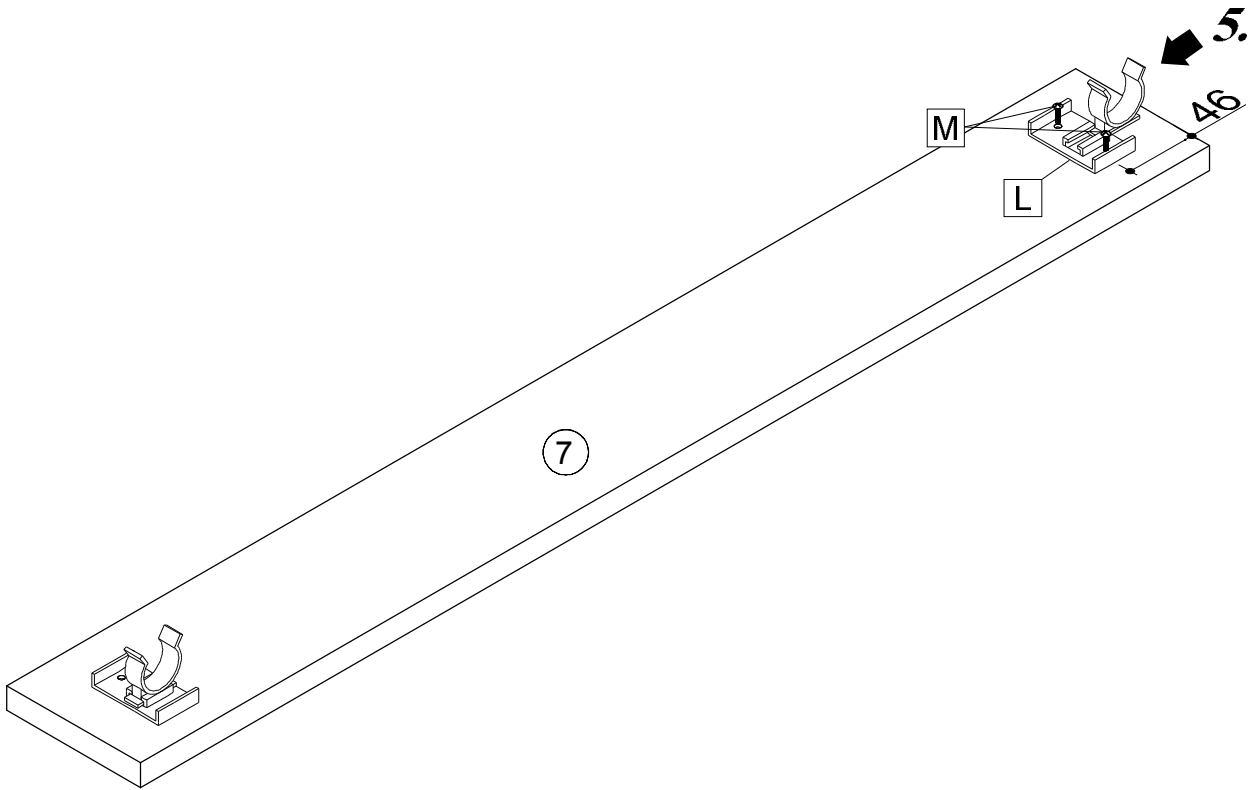



	
L	Ø3,5x16
2x	4x

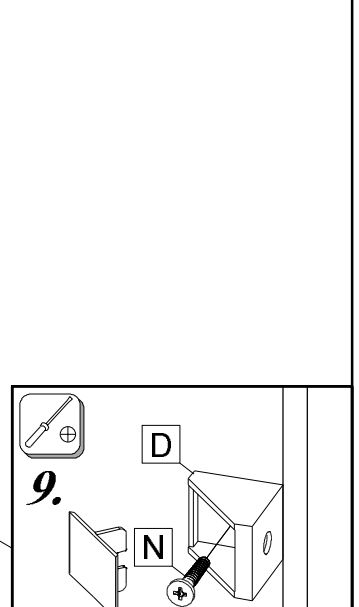
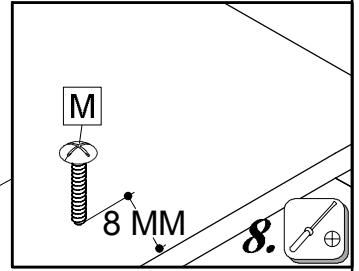
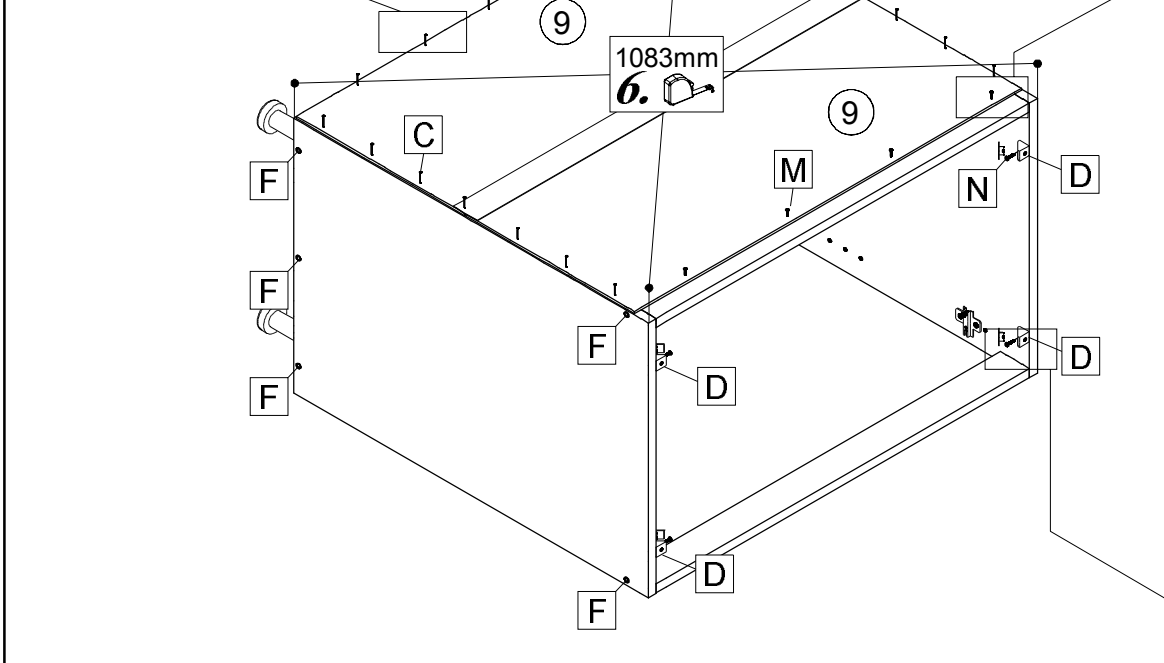
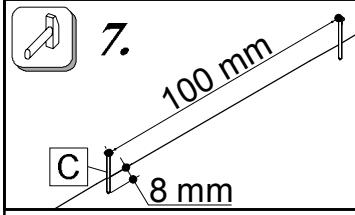

				
C	D	F	M	N
20x	4x	10x	4x	4x

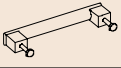

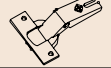
		
E 2x	H 8x	I 4x
Ø3,5x15		

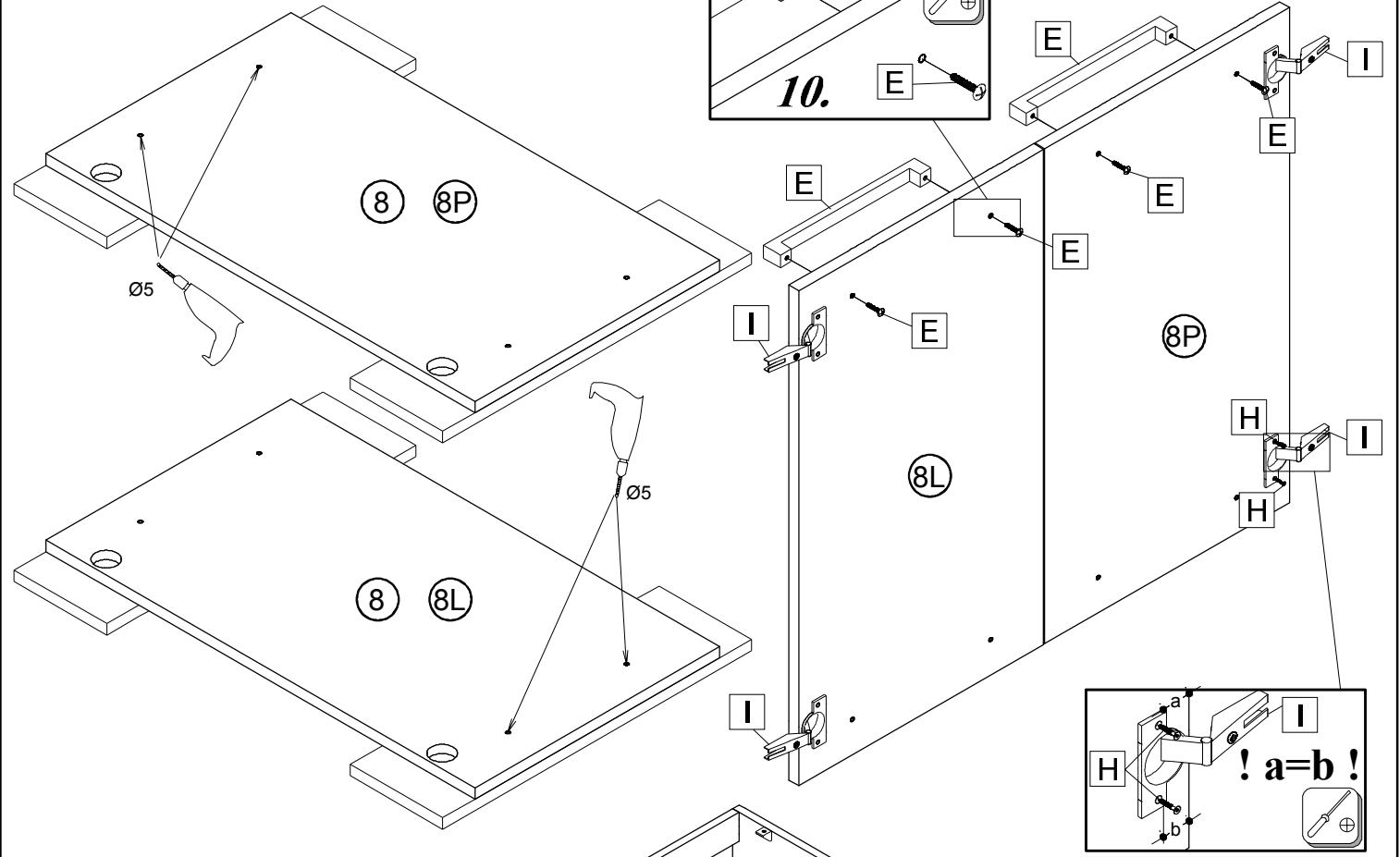

SK ŠABLÓNĀ
 CZ ŠABLONA
 HU SABLON
 DE SCHABLONE

