

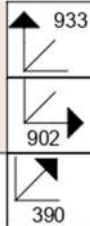

BETTY 02
BE02-007-00





V PRÍPADE REKLAMÁCIE JE POTREBNÉ NAHLÁSIŤ
VÝROBNÉ ČÍSLO VIDITEĽNÉ NA ETIKETE

A 18x	B 23x	C 6x	D 32x	E 5x	F 24x	G 20x	H 20x	J 50x	K 8x
M 4x	0h 45min		4	5,5 x 125	≤ 0,5 kg	0,6m	3m		

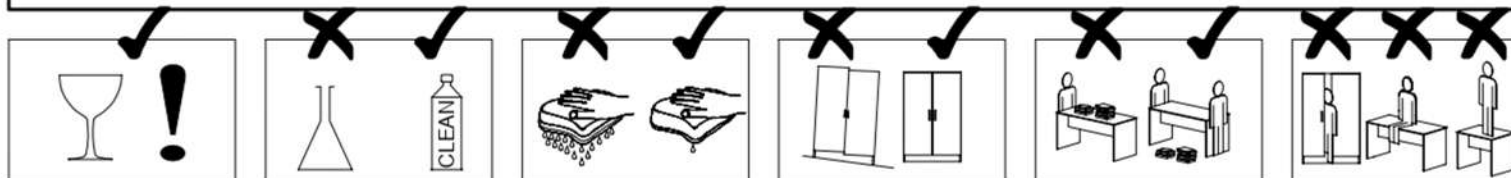
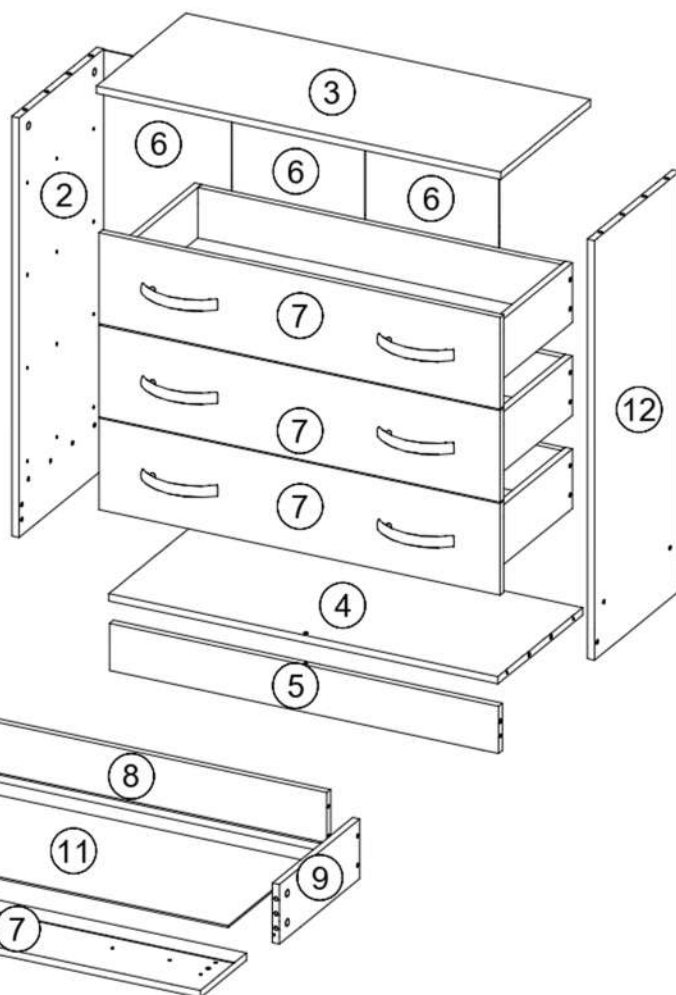

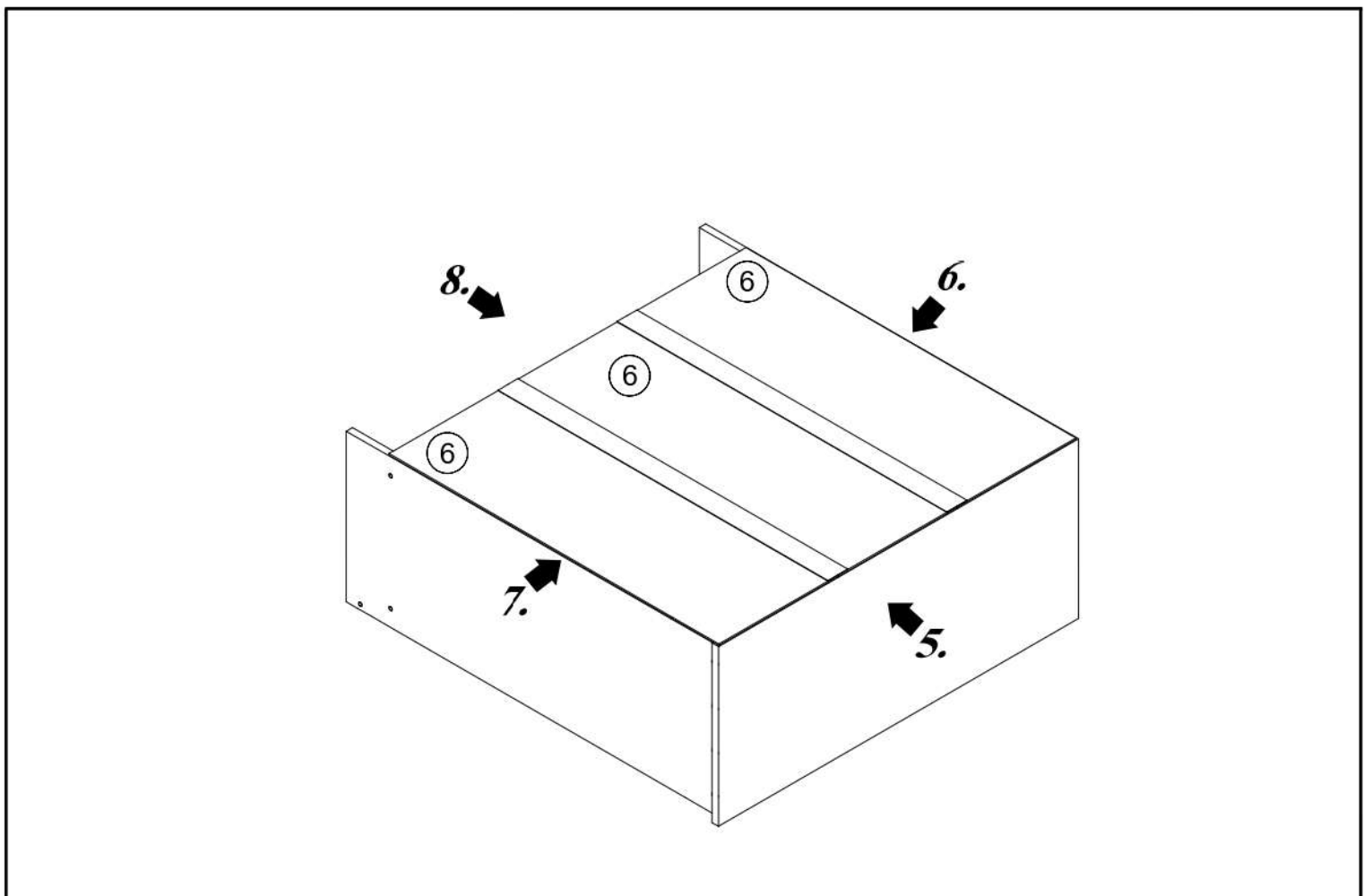
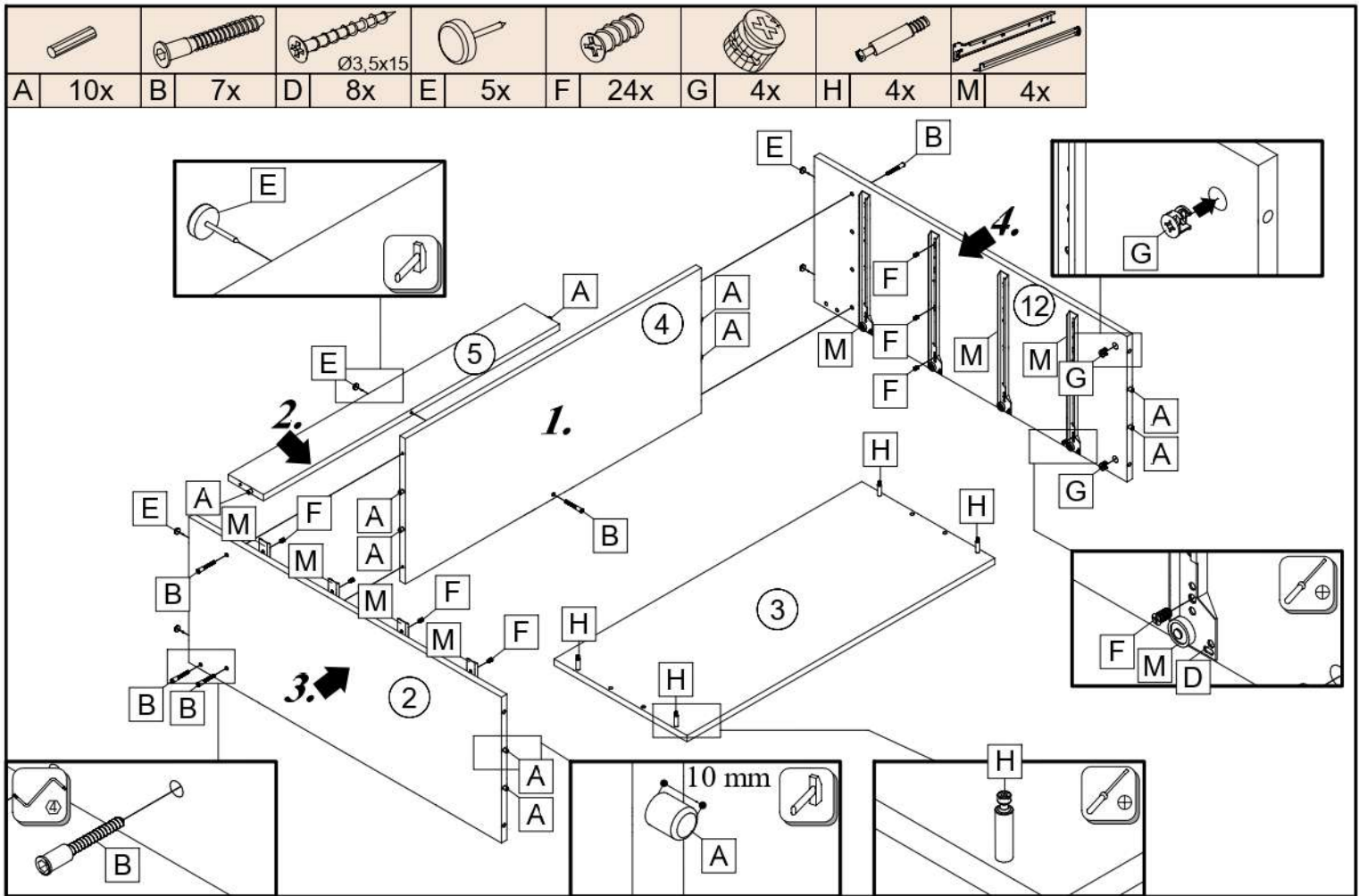

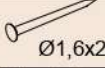

ID	ID	Icon	Dimensions	Quantity	Quantity
01380	②		917*370*16	1x	1/2
01381	③		902*390*16	1x	1/2
01382	④		868*369*16	1x	1/2
01318	⑤		103*868*16	1x	2/2
04062	⑥		826*298*2,5	3x	1/2
01324	⑦		895*200*16	4x	2/2
01327	⑧		811*130*16	4x	2/2
01384	⑨		350*130*16	4x	2/2
01385	⑩		350*130*16	4x	2/2
01386	⑪		346*820*2,5	4x	1/2
01379	⑫		917*370*16	1x	1/2

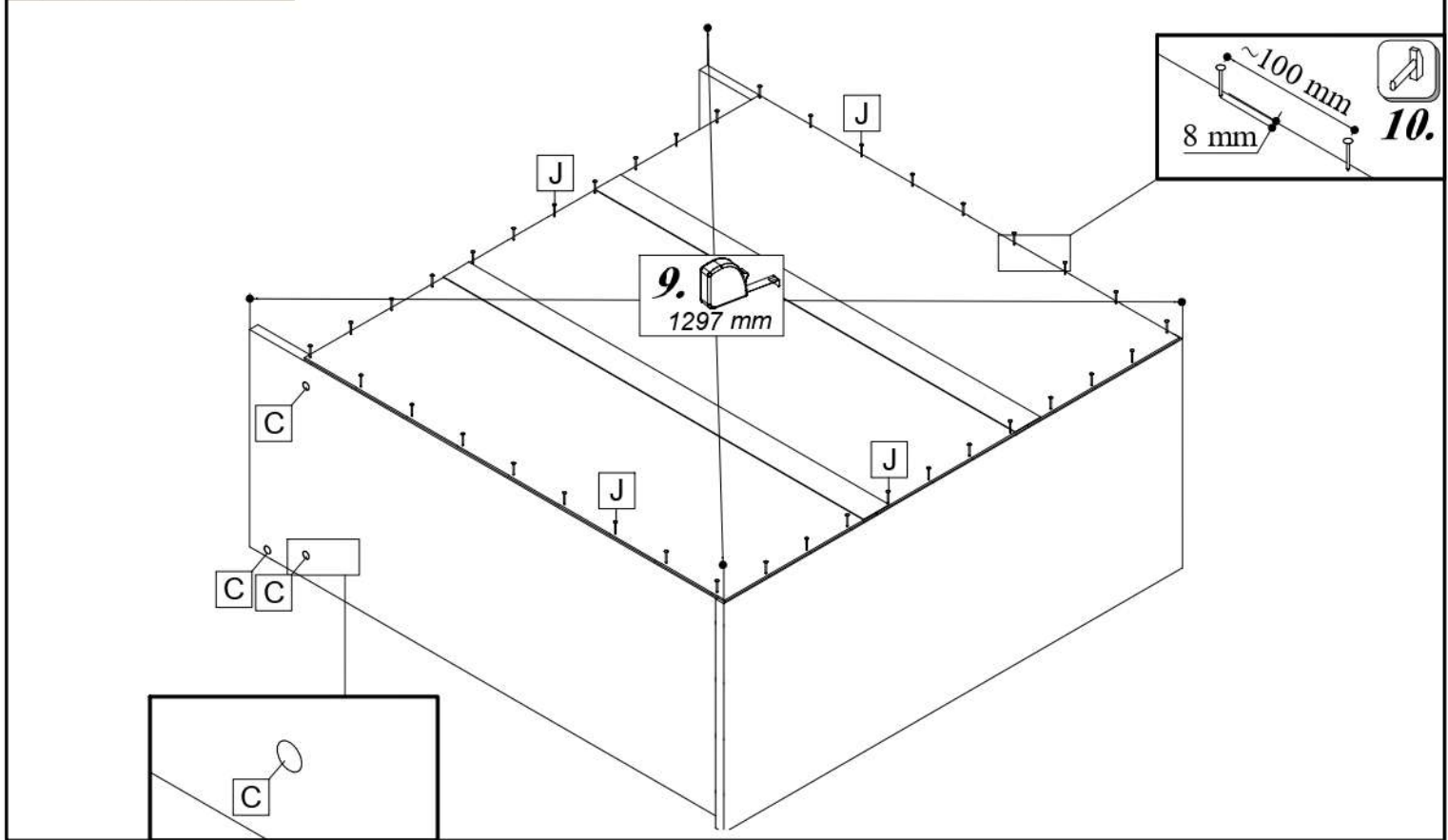

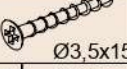

	$\varnothing 1,6 \times 20$		
J	50x	C	6x



			$\varnothing 3,5 \times 15$										
A	8x	B	16x	D	24x	G	16x	H	16x	M	4x	K	8x

