

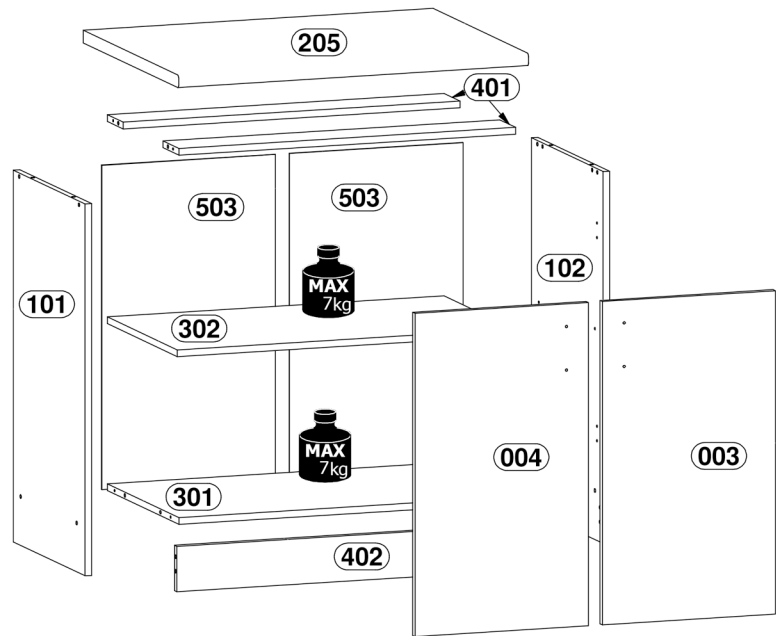

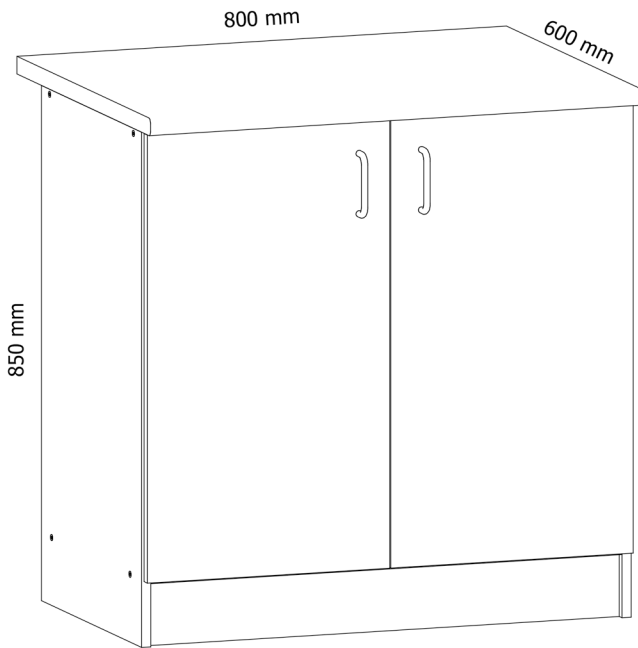

K02-D80

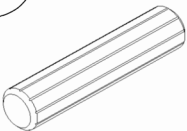
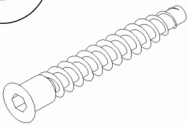
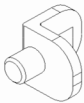
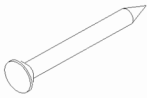
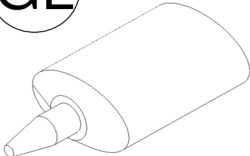
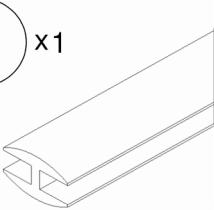

<p>A x16</p>  <p>Ø8x35mm</p>	<p>D x8</p>  <p>Ø6,4x50 mm</p>	<p>E x4</p> 	<p>G x35</p> 
<p>GL x1</p> 	<p>H x1</p>  <p>715 mm</p>	<p>KL x1</p> 	<p>M x2</p> 
<p>W2 x8</p>  <p>Ø3,5x16mm</p>	<p>Y2 x8</p> 	<p>Zc x4</p>  <p>Zc-1</p>  <p>Zc-2</p>	

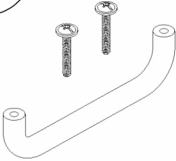
1

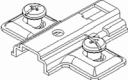
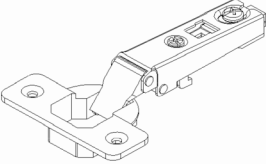
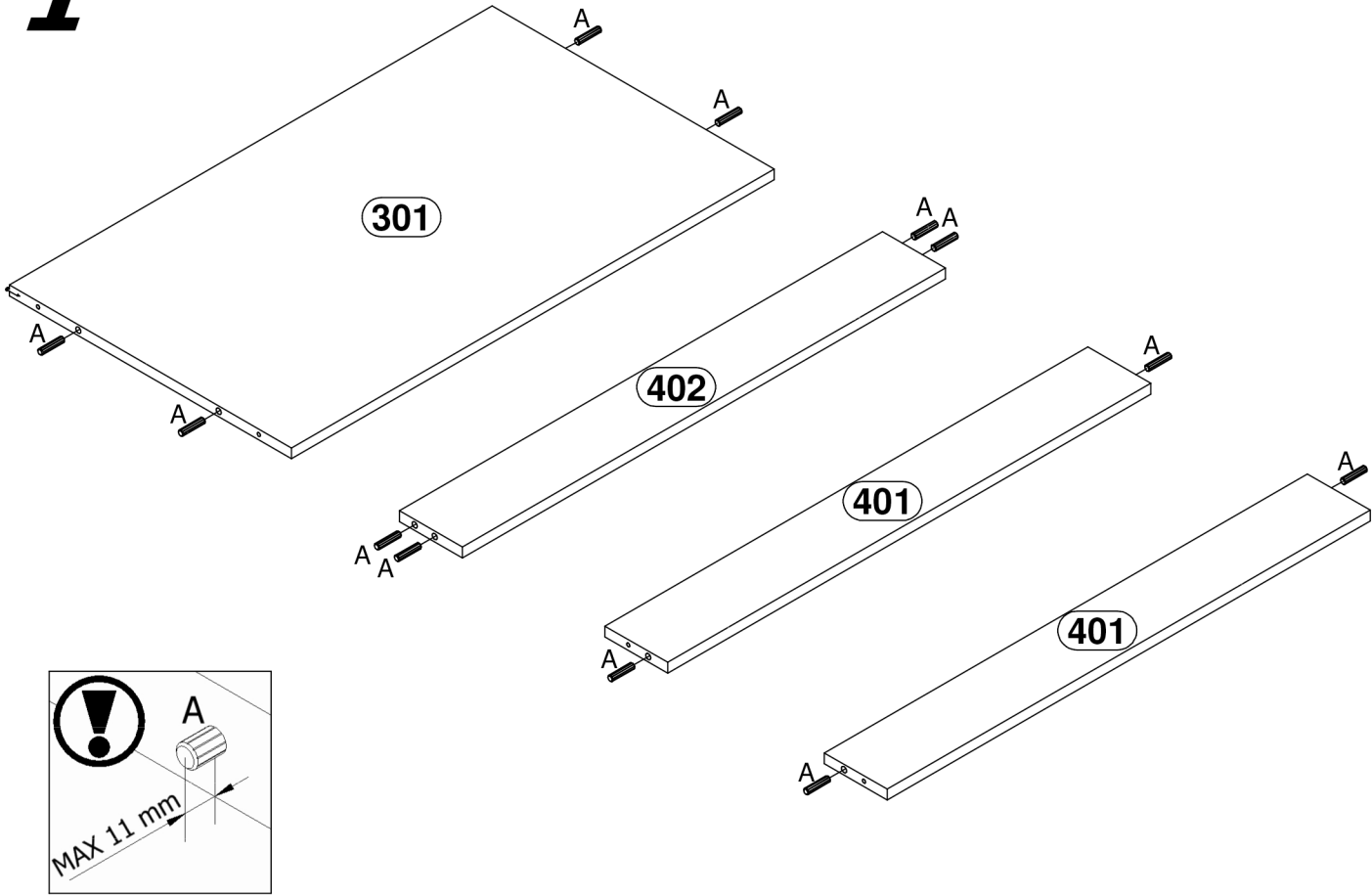

2

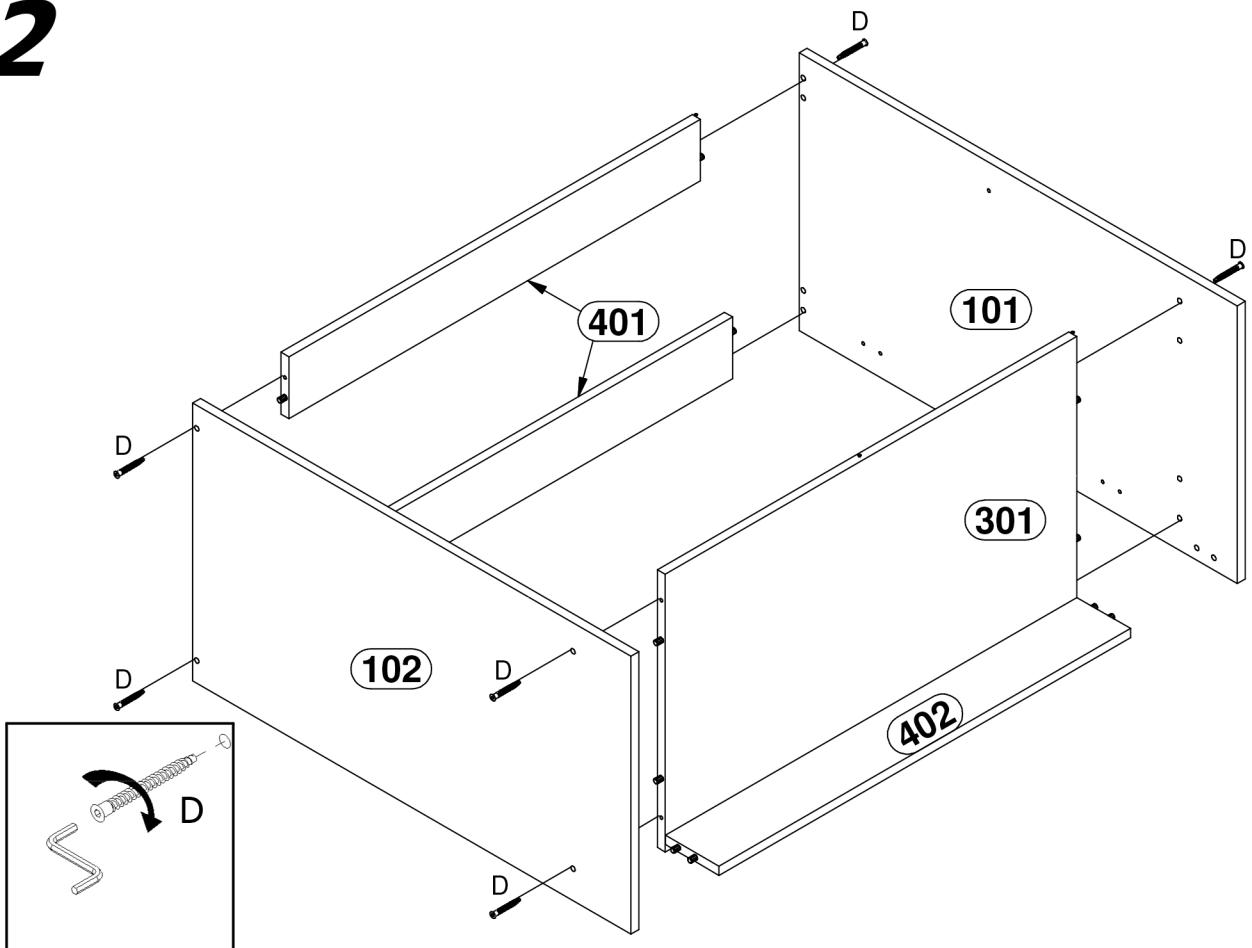

3

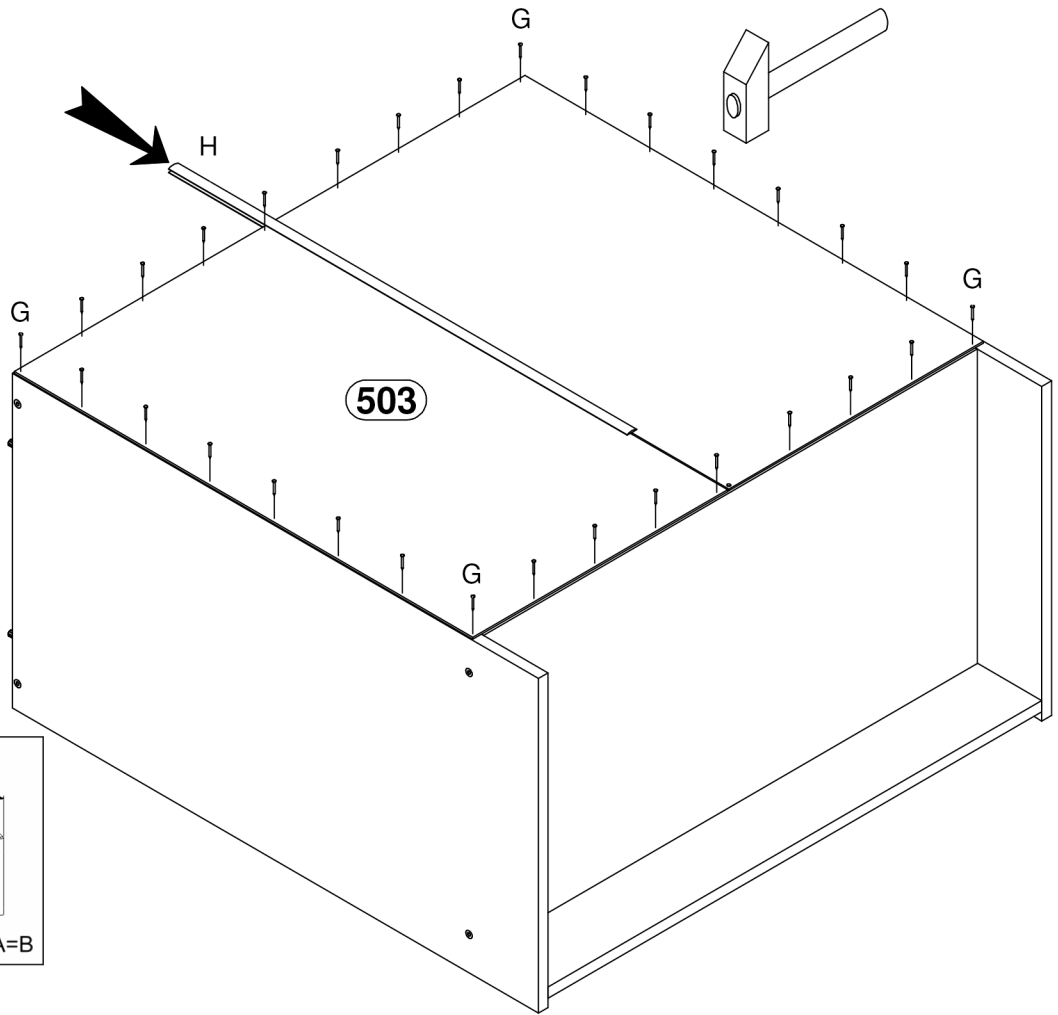

4

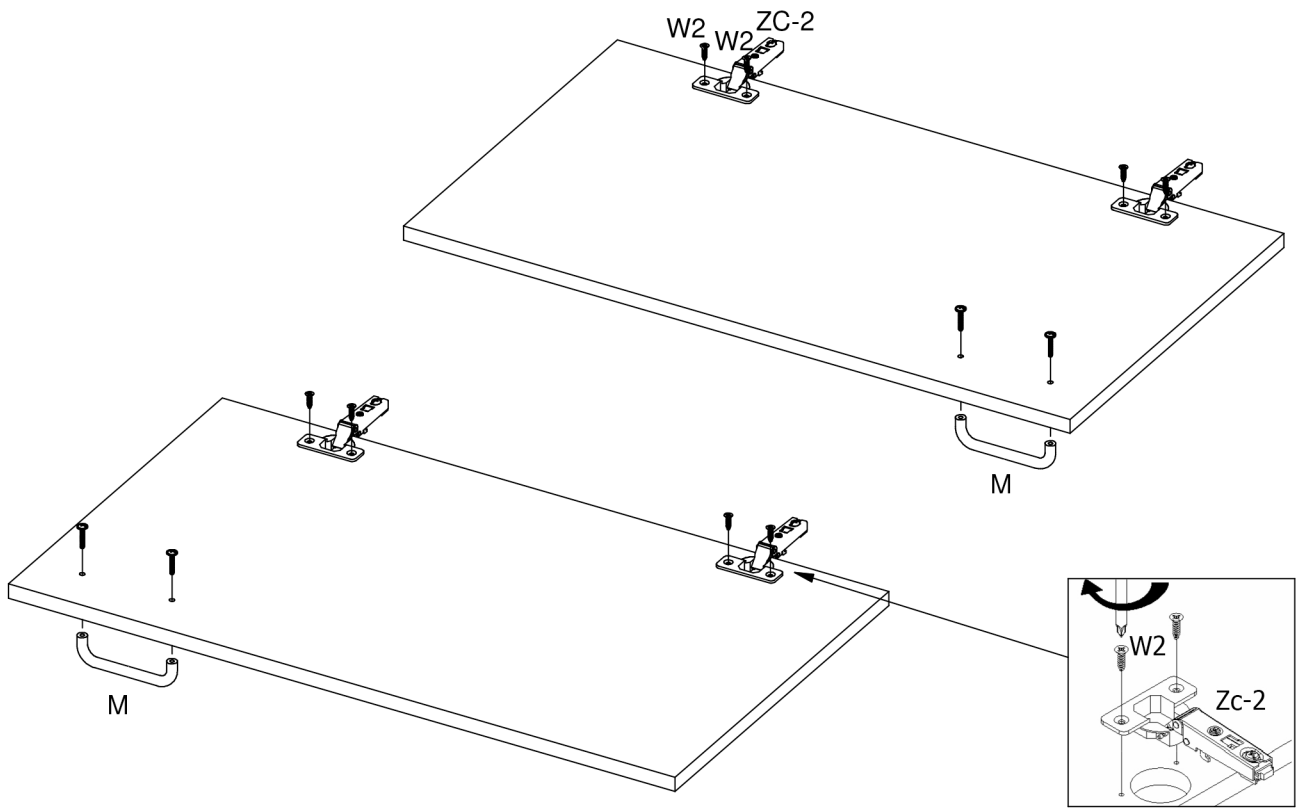

5

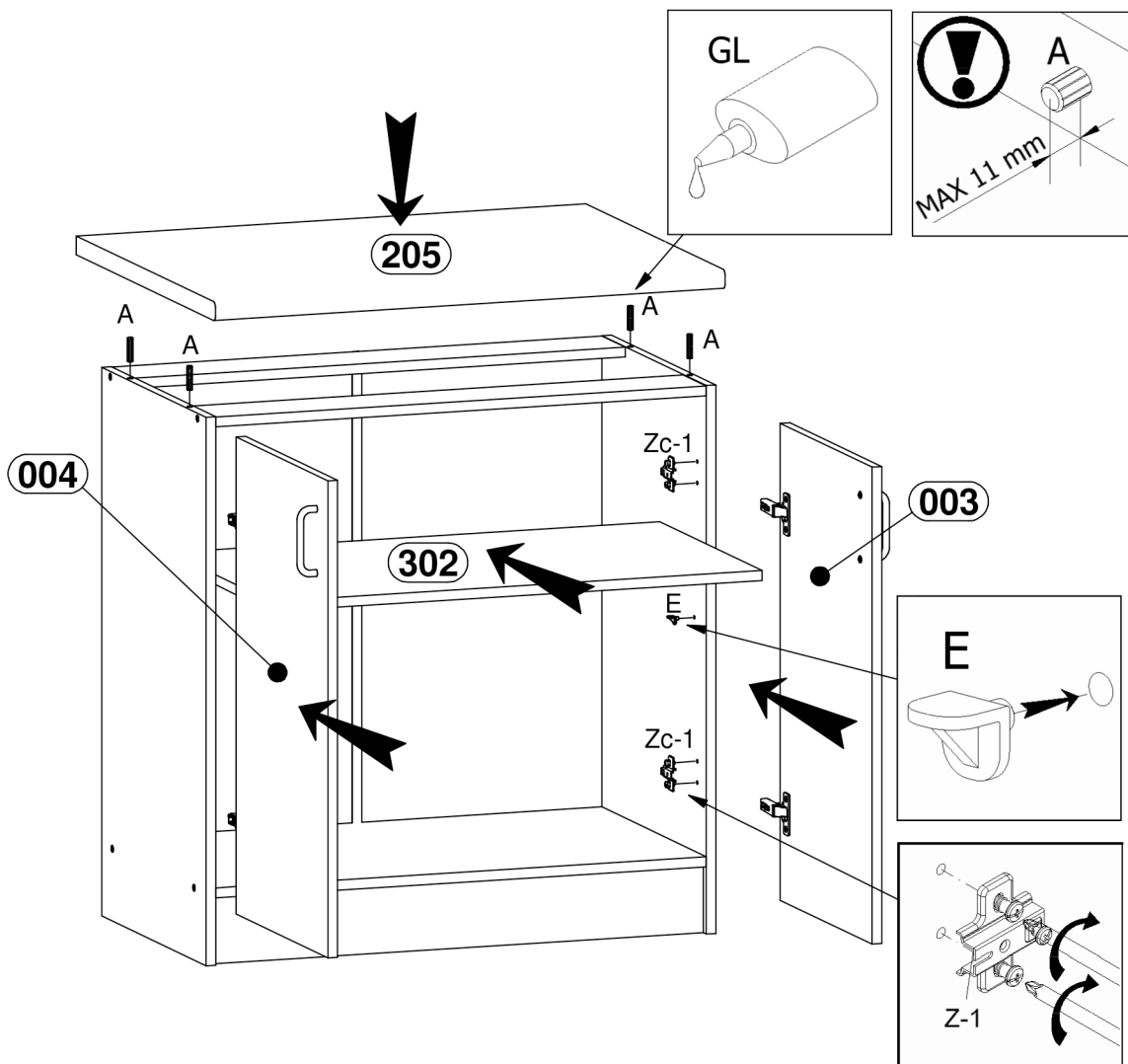

6

