

SK/ NÁVOD NA MONTÁŽ
 CZ/ MONTÁŽNÍ NÁVOD
 HU/ SZERELÉSI UTASÍTÁS
 HR/ UPUTE ZA UGRADNJU
 RO/ INSTRUCTIUNI DE INSTALARE
 SI/ NAVODILA ZA MONTAŽO

DUNAJ TYP 15

	786	mm
	1908	
	786	





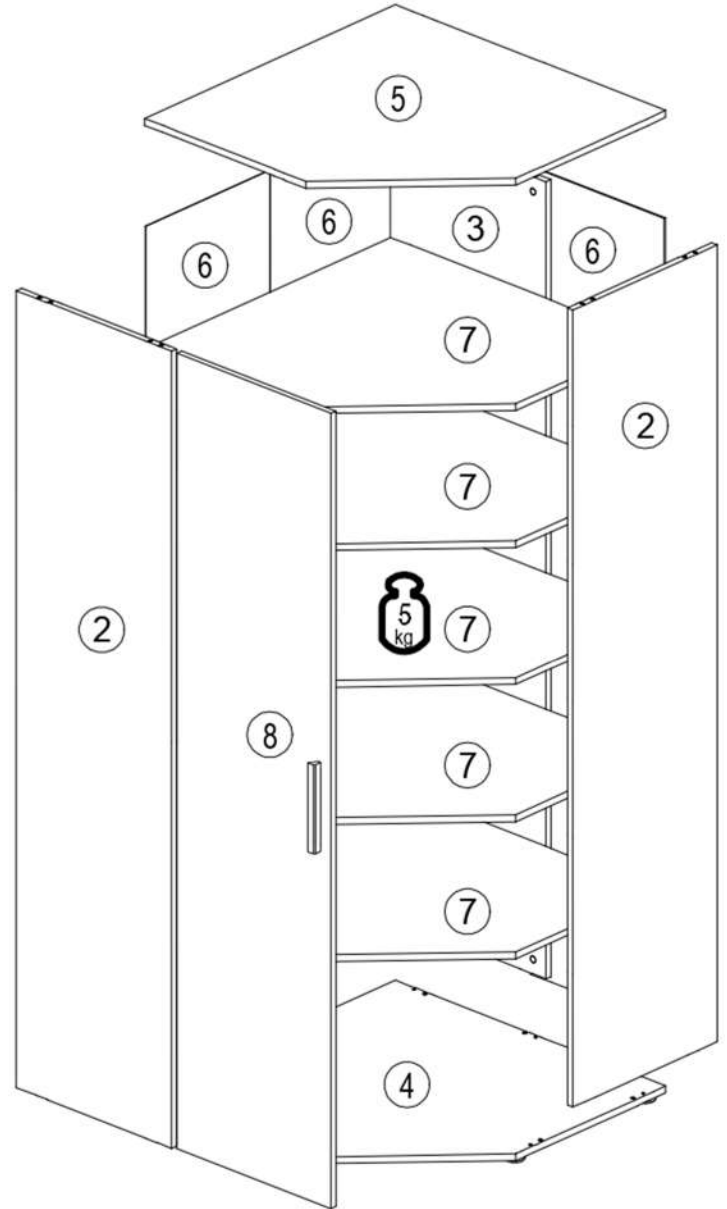
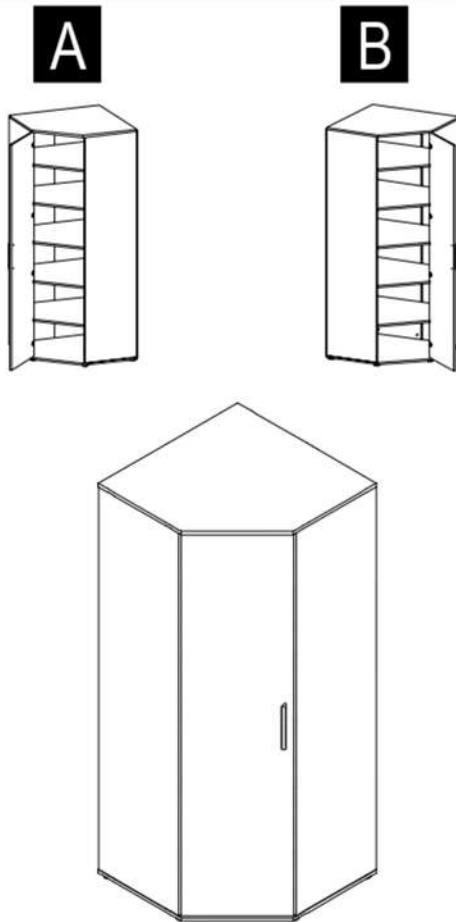

	 120 min		 PZ 2,1	 ≤ 0,5 kg	 3m
--	-------------	--	------------	--------------	--------

ID	Icon	Part No.	Dimensions	Qty	Assembly
12681		1860*449*16	2x	1/4	
12783		1860*449*16	1x	1/4	
12784		781*781*16	1x	3/4	
12785		781*781*16	1x	3/4	
12786		1886*387*2,5	3x	2/4	
12781		748*764*16	5x	4/4 - 3/4	
12690		1856*446*16	1x	2/4	



22244.01 Ø3.5*16	27000.00 Ø8*30	70013.01 5	70021.01 	35101.01 	30080.00 Ø44x15	21102.00 Ø1.2x20	22243.00 Ø3.5x15	22250.00 Ø4x25	31103.00
A 2x	B 12x	C 12x	D 12x	E 25x	F 5x	G 100x	H 8x	J 5x	K 1x
22213.00 Ø4x70	24103.00 Ø8	32315.00 	22601.00 	Q 12x 	36032.00 	36033.00 	22236.00 Ø2.5x16	24008.00 3.0	
L 1x	M 1x	N 1x	P 2x	Q 12x	R 4x	S 4x	T 20x	U 20x	✓



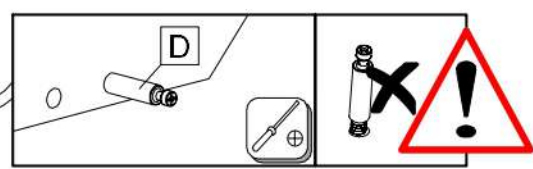
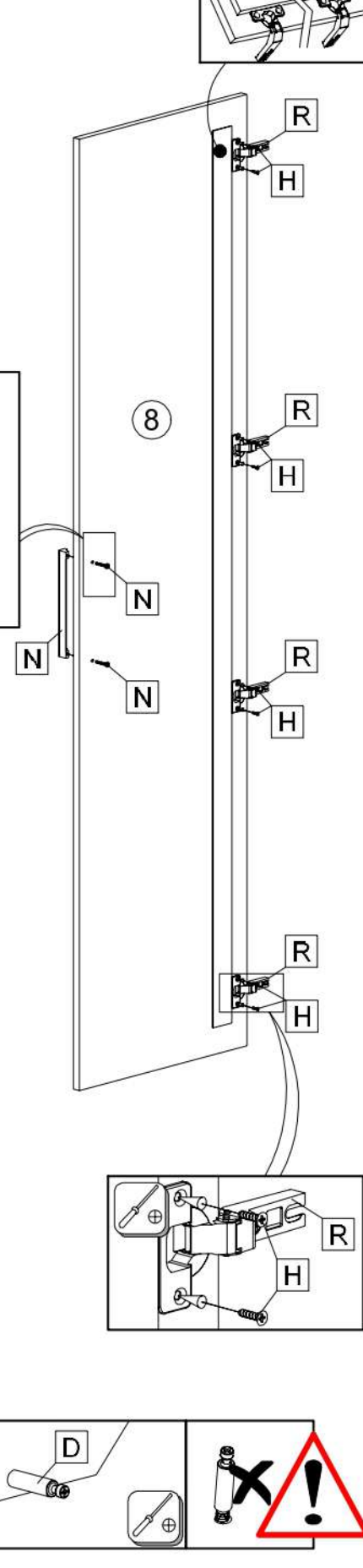
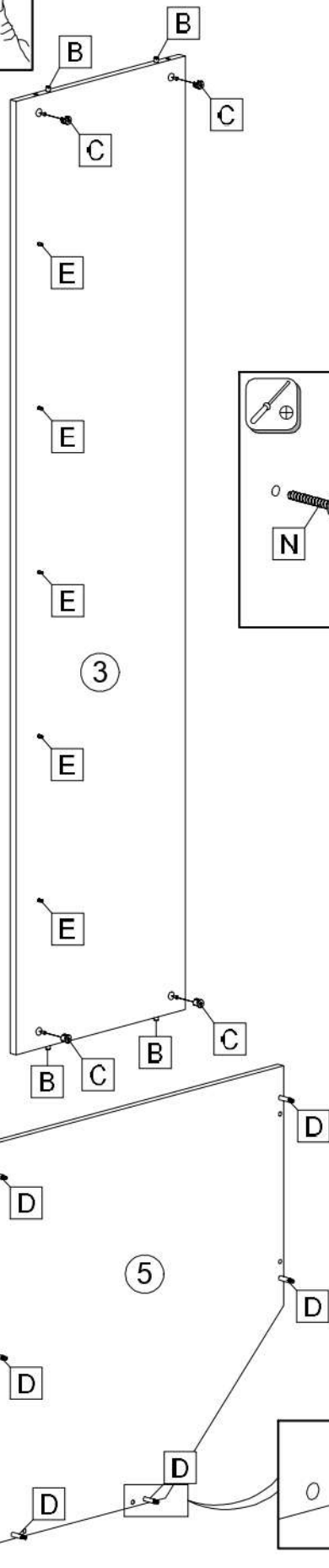
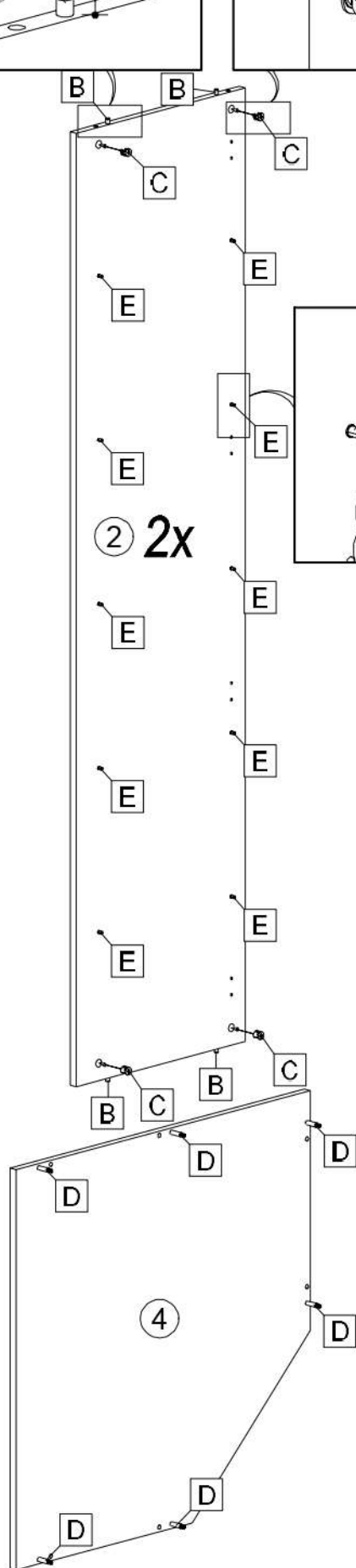
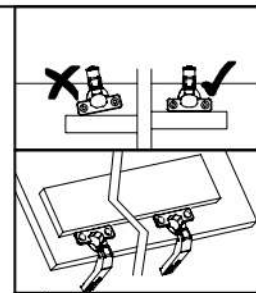
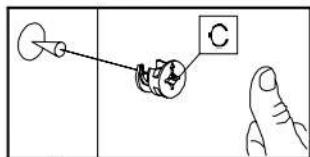
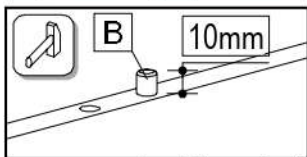

						
B 12x	C 12x	D 12x	E 25x	H 8x	N 1x	R 4x

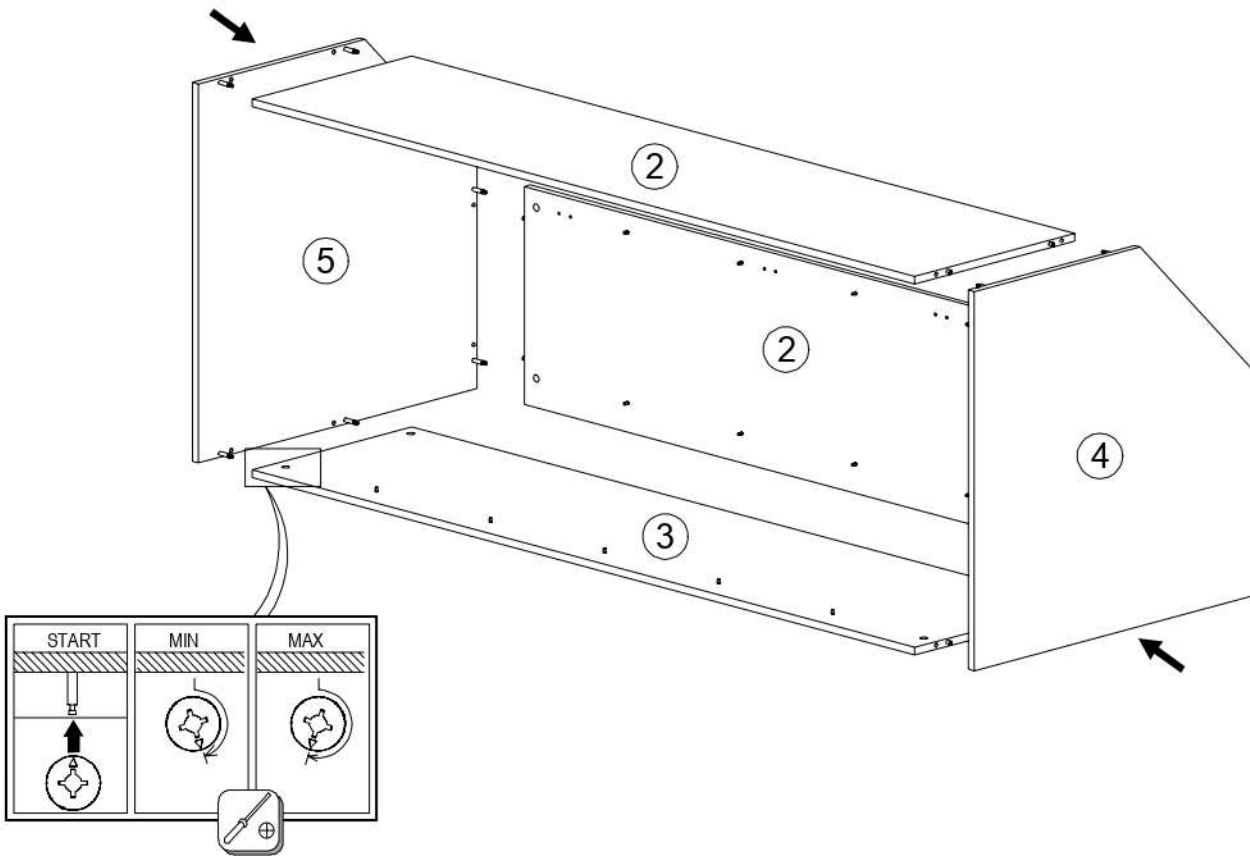



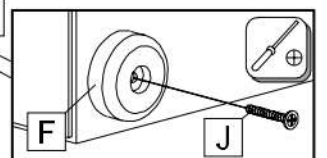
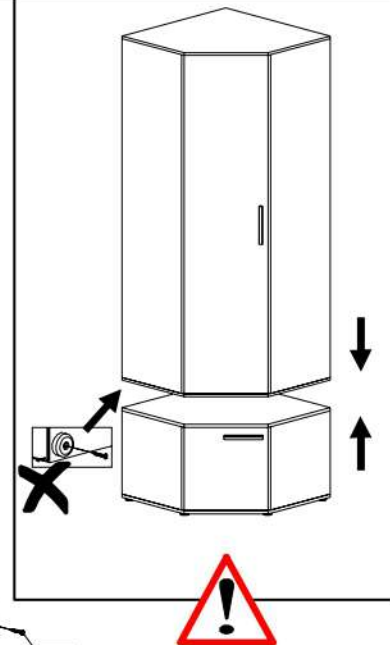
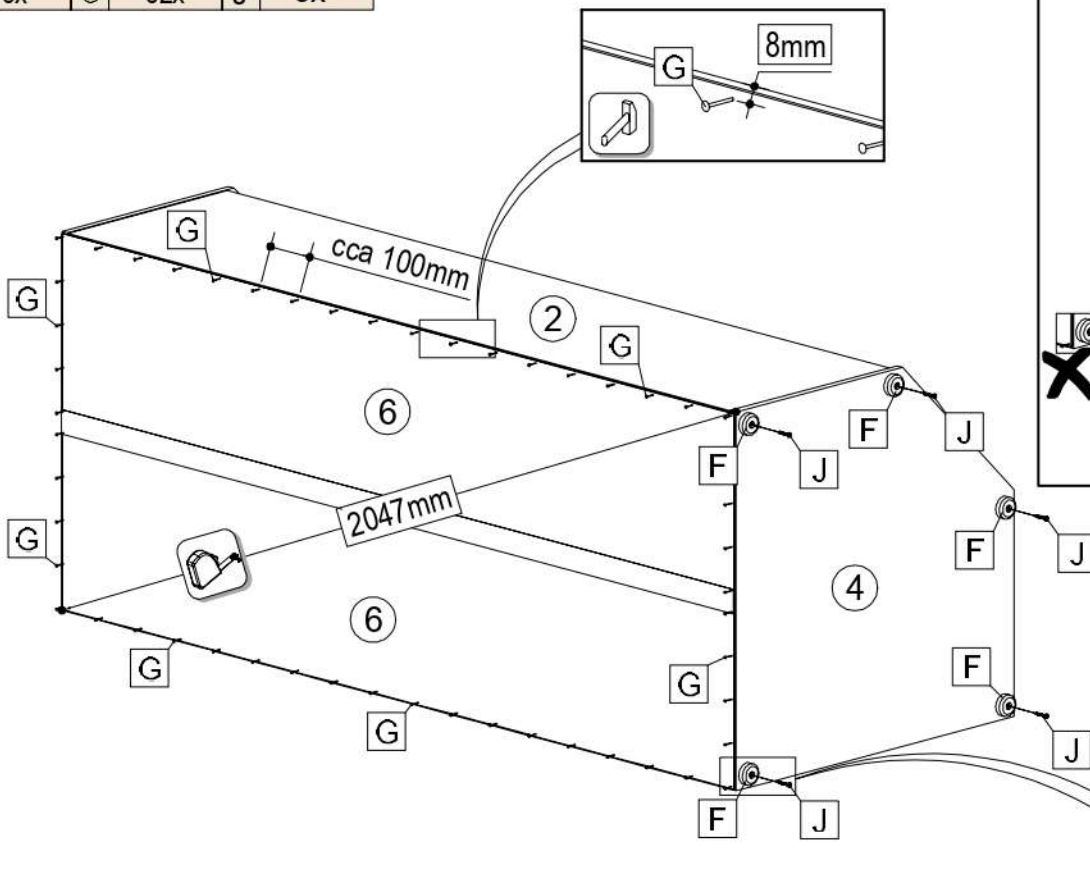

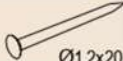

	$\varnothing 44 \times 15$		$\varnothing 1.2 \times 20$		$\varnothing 4 \times 25$
F	5x	G	52x	J	5x

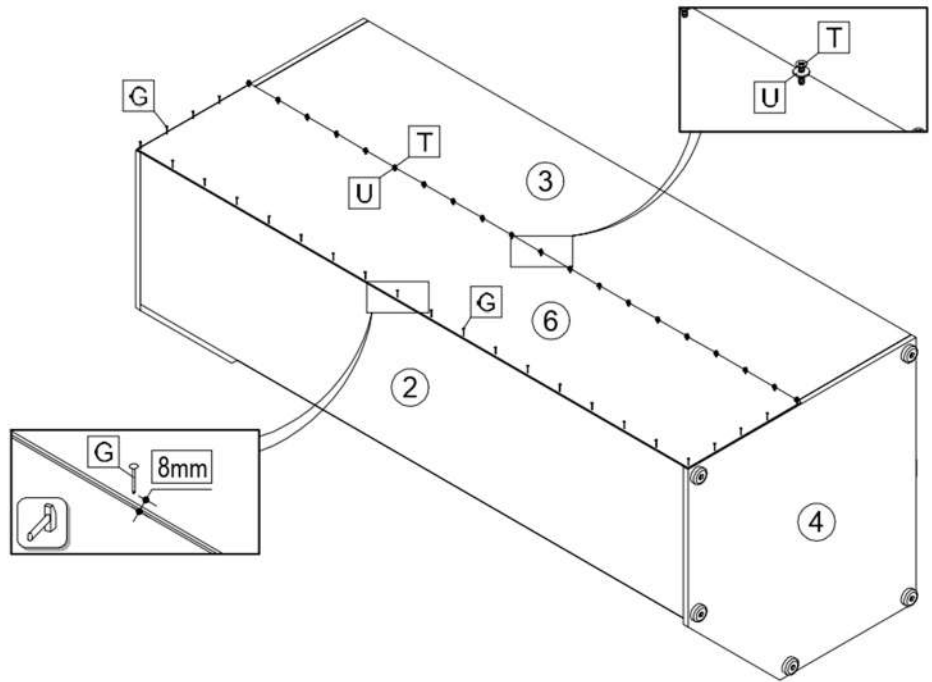

		
Ø1,2x20	Ø2,5x16	3,0
G 24x	T 20x	U 20x

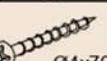

	
Ø3,5x16	
A 2x	K 1x
	
Ø4x70	Ø8
L 1x	M 1x

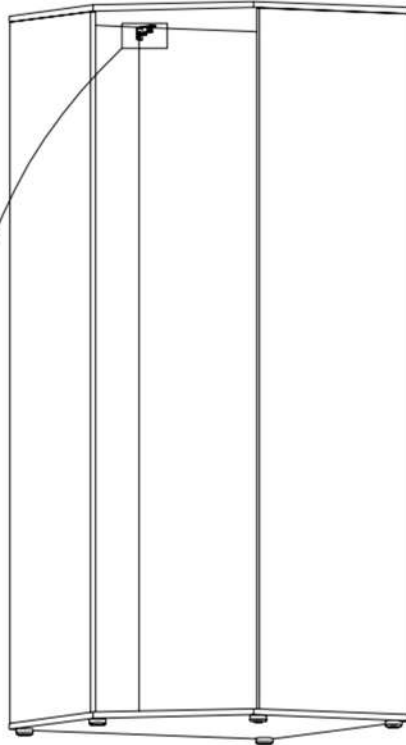
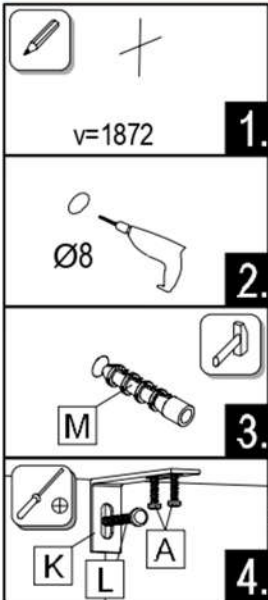
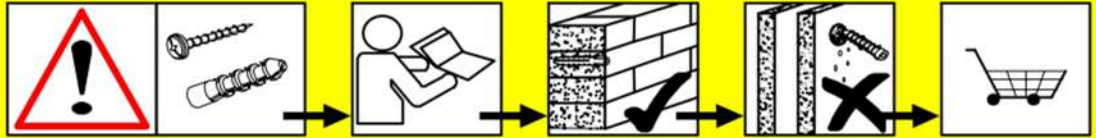

RO

Prudent! Zidul trebuie examinat înainte de asamblare prizele de perete sunt adecvate numai pentru utilizarea în zidărie fermă, cum ar fi betonul bloc sau cărămidă. Nu folosiți zidăria zidurilor de perete, cum ar fi cărămida goală, blocul ușor, suprafețe cum ar fi gips-carton sau altă încadrare sisteme. Dacă este cazul, trebuie folosite anumite prize de perete! Acestea sunt disponibile la un magazin specializat (magazin de hardware). În caz de nerespectare, producătorul / vânzătorul cu amănuntul sau importatorul nu își asumă răspunderea.

SK

Upozornenie! Pevnosť steny sa musí pred montážou bezpodmienečne skontrolovať. Univerzálne hmoždenky, ktoré sú obsiahnuté v balení, používajte jedine pre pevné murivo ako je betón/tehla. Hmoždenky sa nesmú používať v prípade ľahkého stavebného muriva, dutina tehla, u sádkartónových dosiek alebo iných konštrukcií rámu. U týchto murív je nutné použiť špeciálne hmoždenky! Tieto je možné dostať v špeciálnych predajniach so stavebným materiálom (stavebniny). Pri nedodržíaní pokynov nepreberajú výrobcovia/predajci a dodávateľa zodpovednosť za vzniknuté škody.

HU

Vigyázat! Szerelés előtt a falfelületet feltétlenül vizsgálja meg. A mellékelt univerzális tiplí kizárólag stabil falazathoz használható mint például beton/tégla. A falí tiplí nem használható könnyű építőkövek hez, üreg tégla, gipszkarton lapokhoz vagy más fávázás építményekhez. Ezekhez a falfelületekhez csak speciális tiplik használhatóak, melyek szaküzletekben (barkácsáruházakban) beszerezhetőek. Fentiek figyelmen kívül hagyása esetén a gyártó/kereskedő vagy forgalmazó nem vállal felelősséget.

CZ

Upozornění! Před montáží je nutné zkontrolovat stav stěny. Příložené univerzální hmoždinky jsou určeny pouze k použití pro pevné zdivo jako beton/cihly. Hmoždinky do zdi se nesmí používat u dutinová cihla, zdiva jako pórovitý stavební kámen, sádkartónová deska nebo jiný měkký materiál. U těchto zdív jsou nutné použít speciální hmoždinky! Jsou k dostání v speciálních prodejnách se stavebním materiálem. Při nedodržení těchto pokynů výrobce/prodejce a dovozce neručí za způsobené škody.

HR

Pažnja! Prije montaže obavezno provjerite svojstvo zida. Priložene univerzalne tiplje namijenjene su isključivo za masivne zidove od betona/opeke. Tiplje za masivne zidove ne smiju se koristiti za zidove kao npr šupljina opeka laki sastavni elementi, gips-kartonske ploče ili drugi modularni načini gradnje. Za te zidove potrebne su eventualno specijalne tiplje! Iste su dostupne u specijaliziranim trgovinama građevinskim materijalom. U slučaju nepridržavanja prethodno navedenih napomena, proizvođač/trgovac i uvoznik ne preuzimaju odgovornost!

SI

Pozor! Pred montažo preverite stanje stene. Priloženi univerzalni mozniki so izključno samo za uporabo na čvrstem zidovju, kot sta beton in opeka. Stenski mozniki se ne smejo uporabljati pri zidovju kot so votlina opeke, zidaki za lahko gradnjo, mavčne plošče ali druge okvirne gradnje. Pri teh zidovjih morate v danih primerih uporabljati posebne moznike. Ti so na voljo v specializiranih trgovinah (trgovinah z gradbenim materijalom) Pri upoštevanju se s strani proizvajalca/trgovca in uvoznika ne prevzame jamstvo

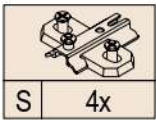
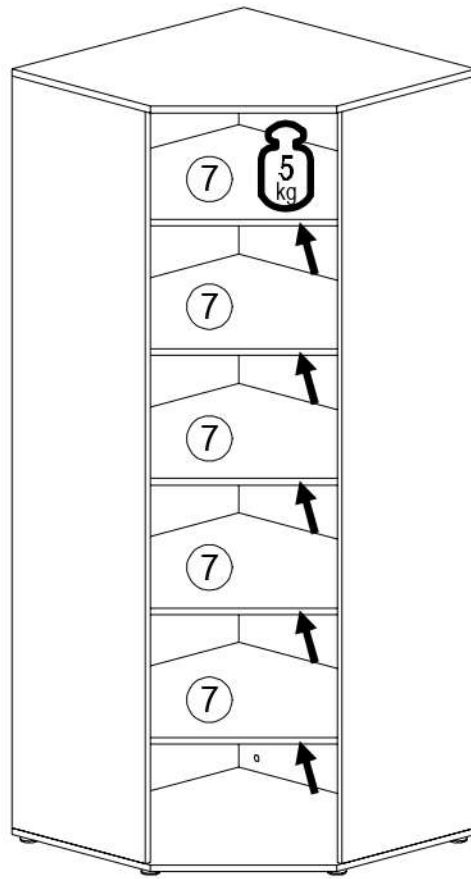

A

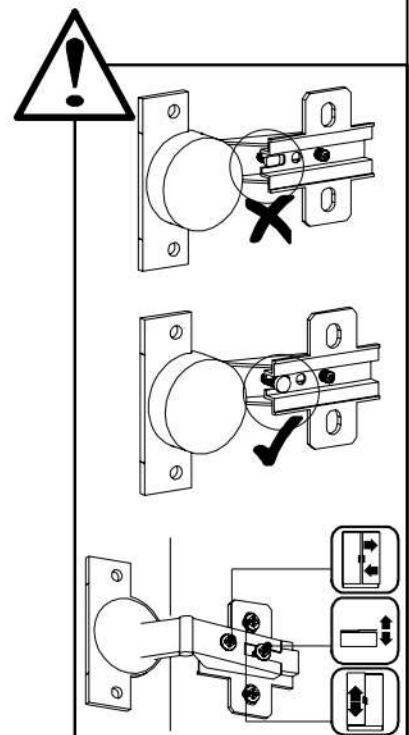
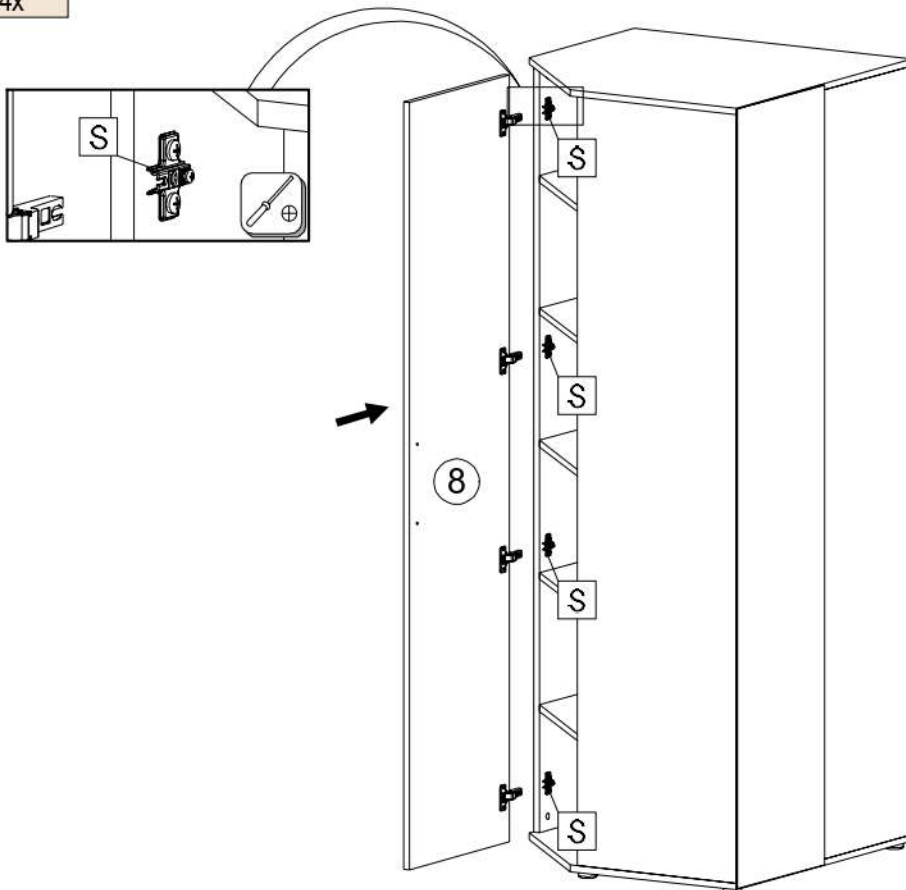

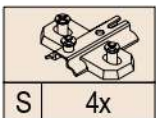

B

