

SK/ NÁVOD NA MONTÁŽ
 CZ/ MONTÁŽNÍ NÁVOD
 HU/ SZERELÉSI UTASÍTÁS
 HR/ UPUTE ZA UGRADNJU
 RO/ INSTRUCTIUNI DE INSTALARE
 SI/ NAVODILA ZA MONTAŽO

DUNAJ TYP 14

	783	mm
	508	
	781	

	100 min		PZ 2	≤ 0,5 kg	3m



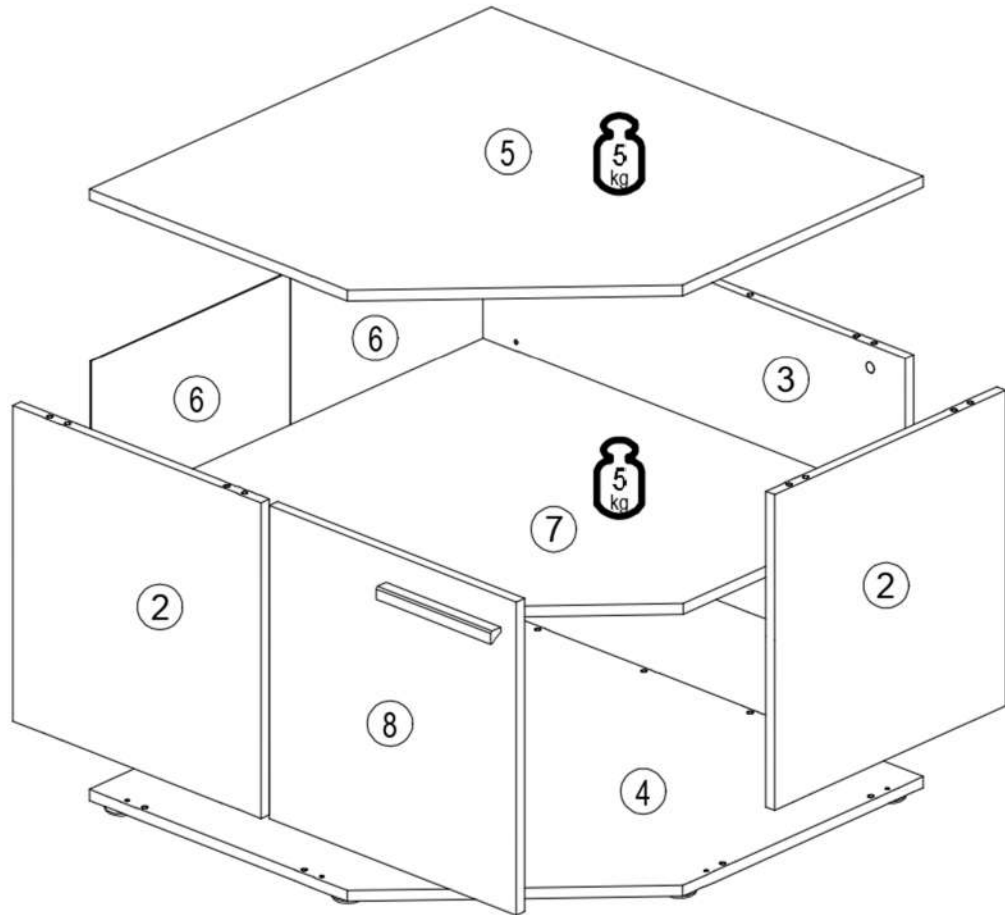
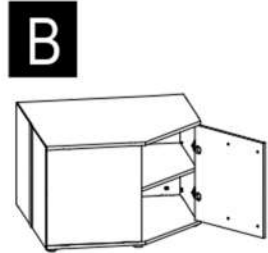
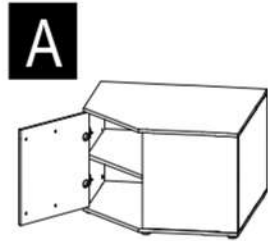
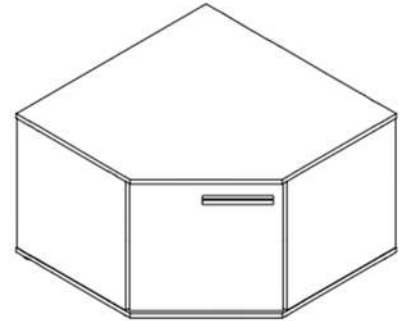



ID	QTY	SIZE	QTY	QTY
12724	②	460*449*16	2x	2/2
12777	③	460*764*16	1x	1/2
12778	④	781*781*16	1x	1/2
12779	⑤	781*781*16	1x	1/2
12780	⑥	486*387*2,5	2x	1/2
12781	⑦	748*764*16	1x	1/2
12782	⑧	456*446*16	1x	2/2

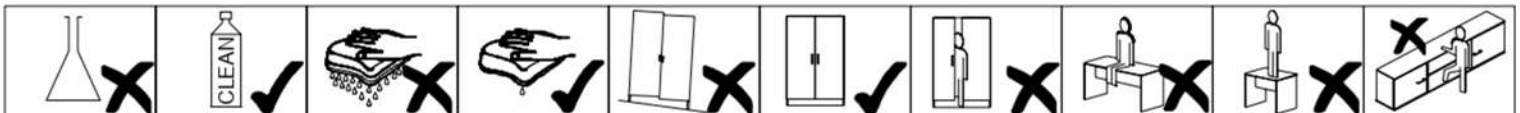

22244.01 Ø3.5*16	27000.00 Ø8*30	70013.01 5	70021.01 	35101.01 	30080.00 Ø44x15	21102.00 Ø1.2x20	22243.00 Ø3.5x15	22250.00 Ø4x25	31103.00
A 2x	B 16x	C 12x	D 12x	E 5x	F 5x	G 25x	H 4x	J 5x	K 1x



22213.00 Ø4x70	24103.00 Ø8	32315.00 	22601.00 		36032.00 	36033.01
L 1x	M 1x	N 1x	P 2x	Q 12x	R 2x	S 2x



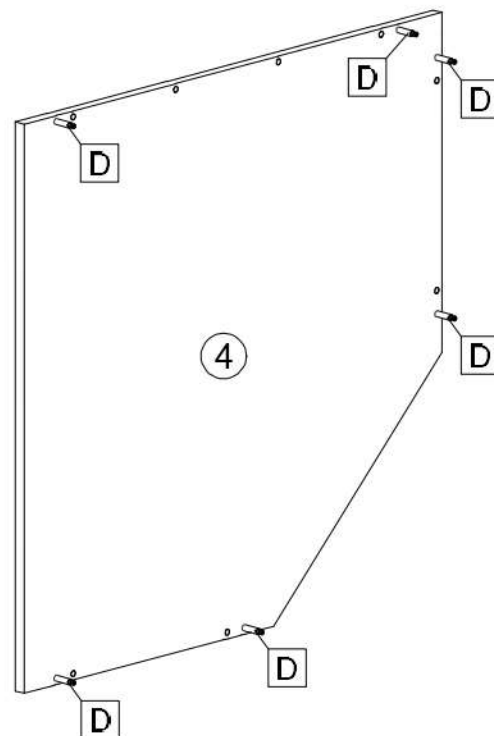
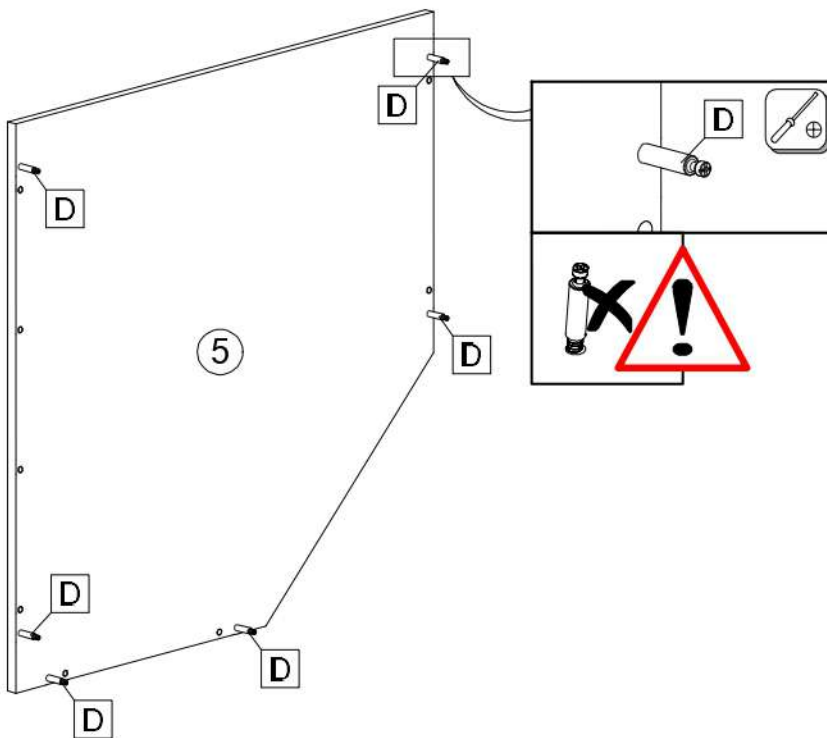
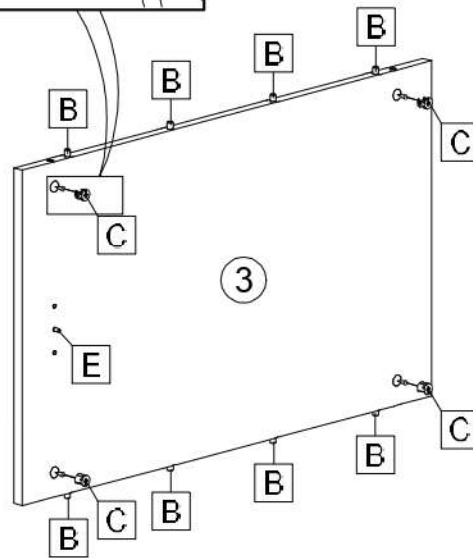
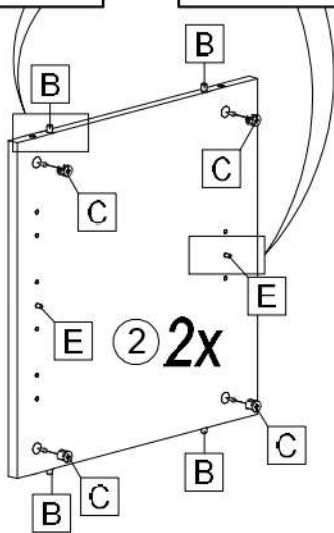
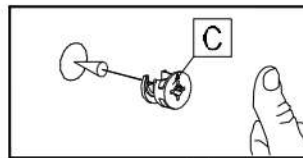
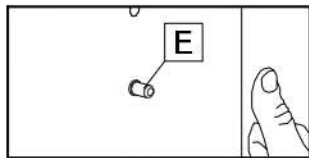
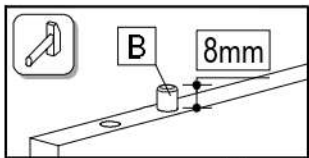

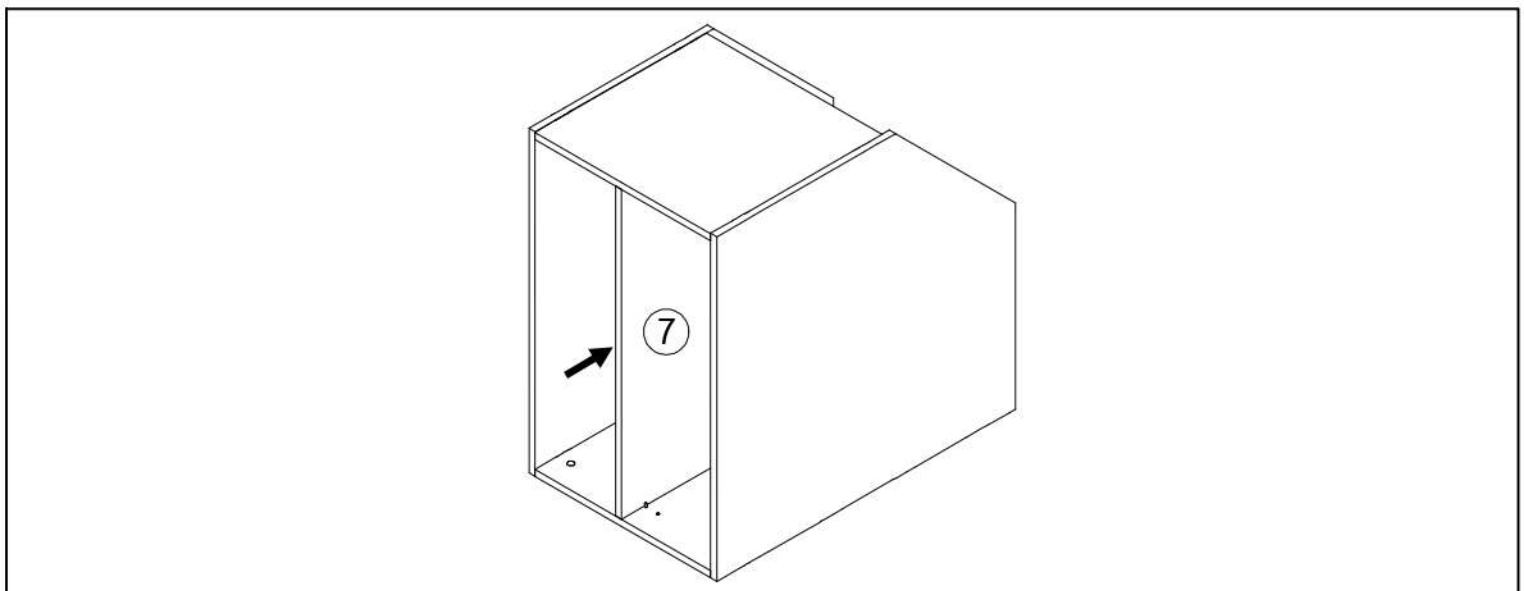
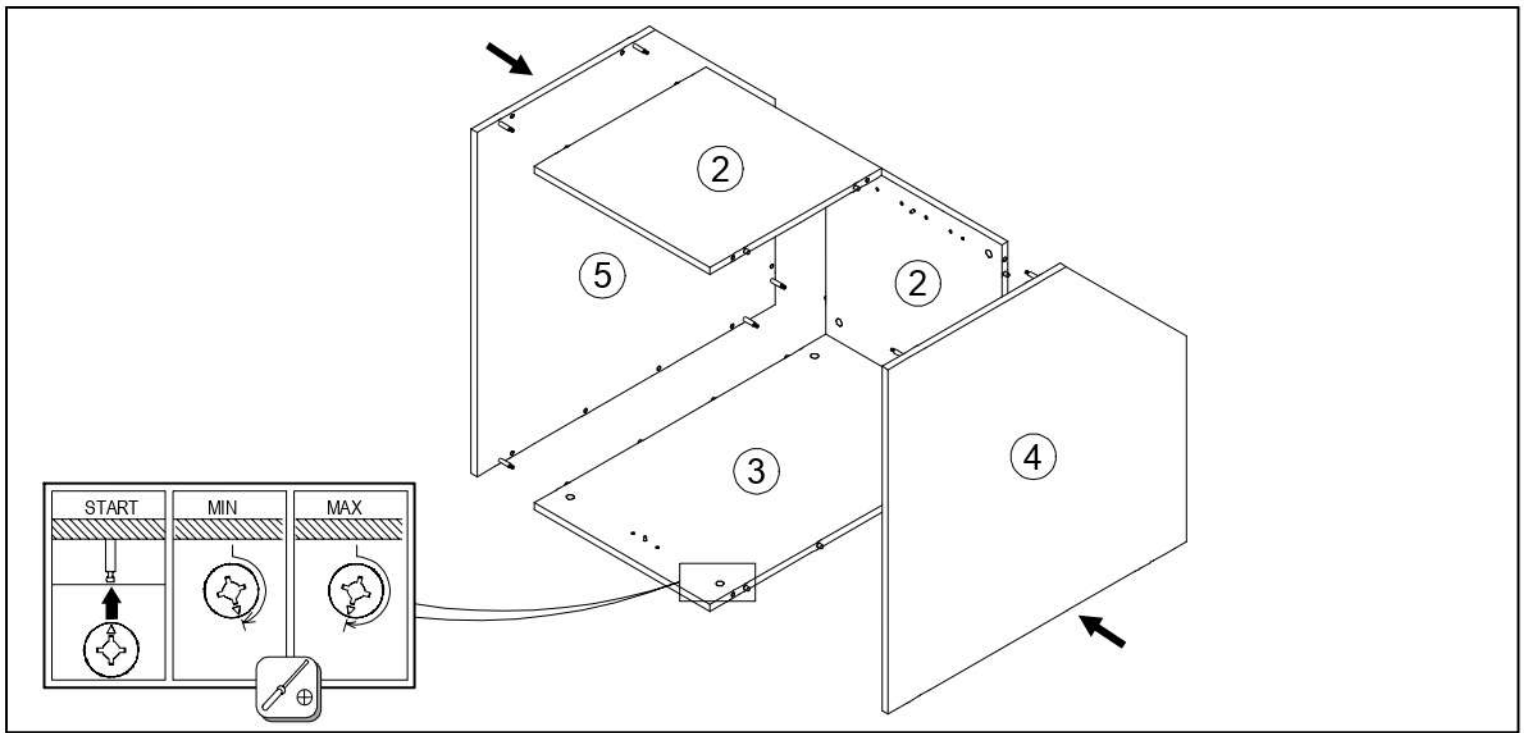
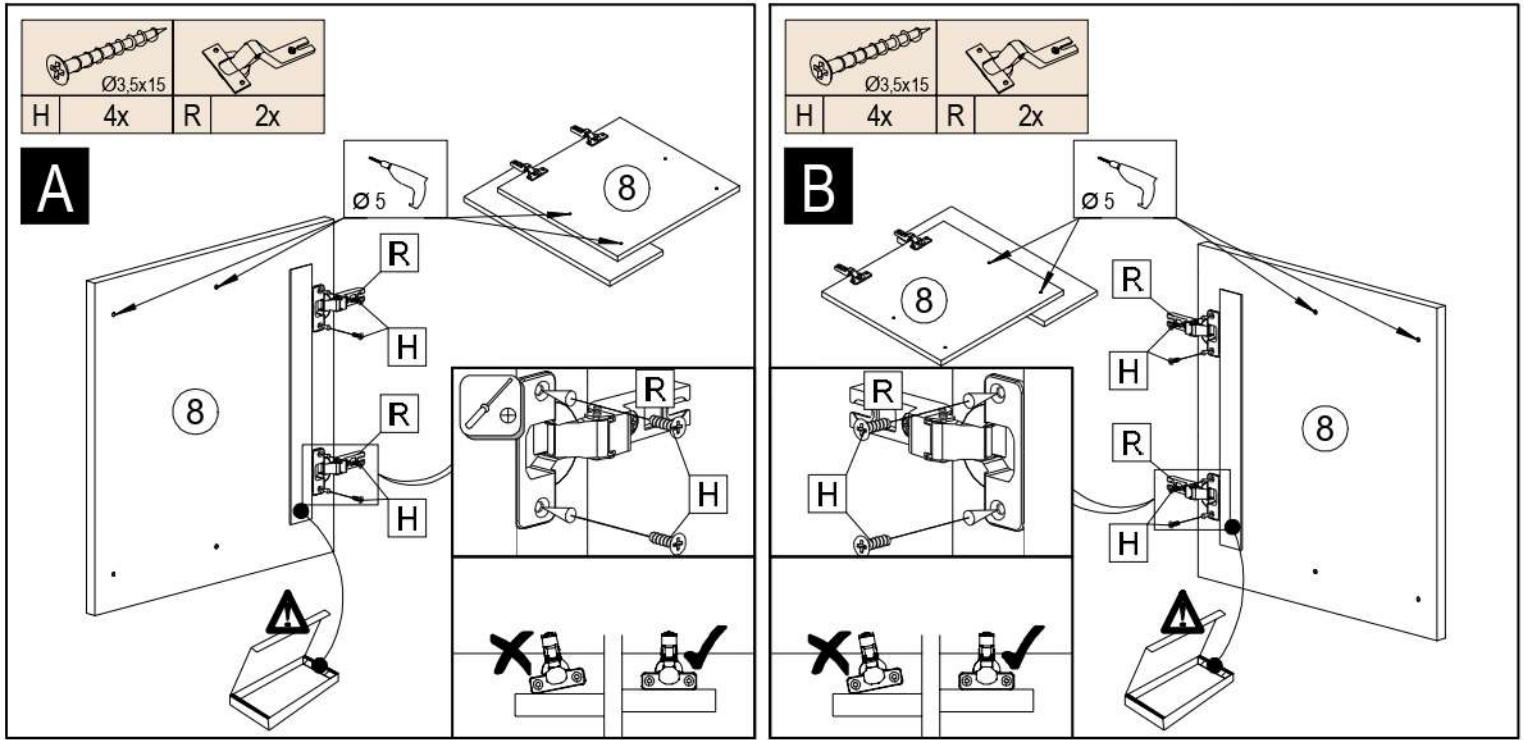

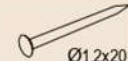
						
B 16x	C 12x	D 12x	E 5x	H 4x	N 1x	R 2x



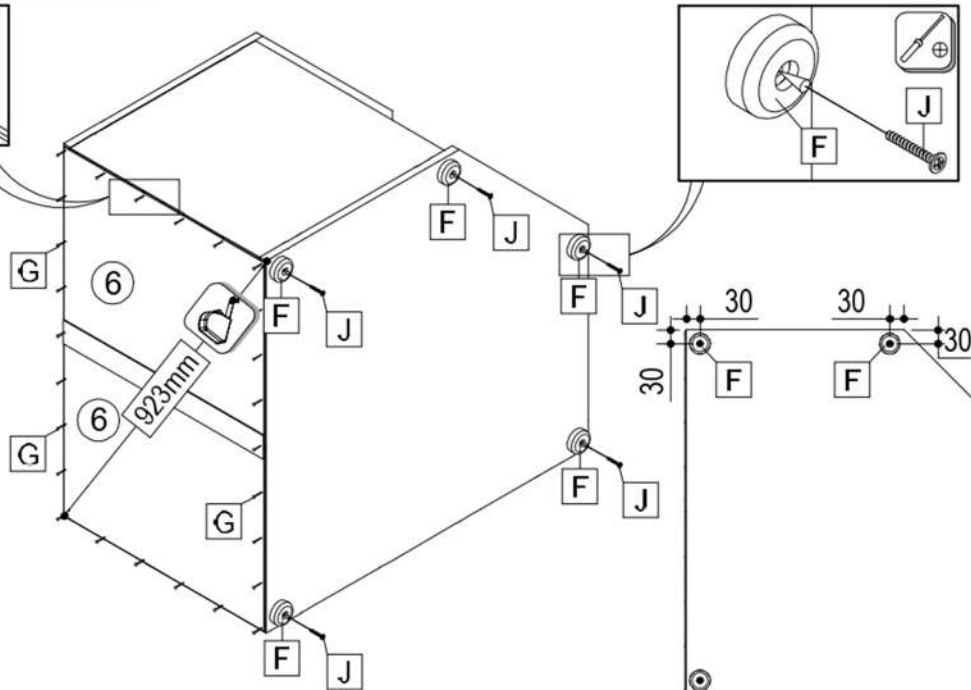
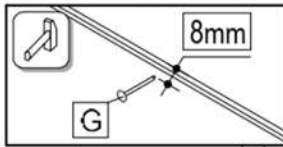

		
Ø44x15	Ø1,2x20	Ø4x25
F 5x	G 25x	J 5x



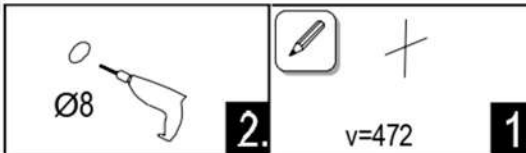
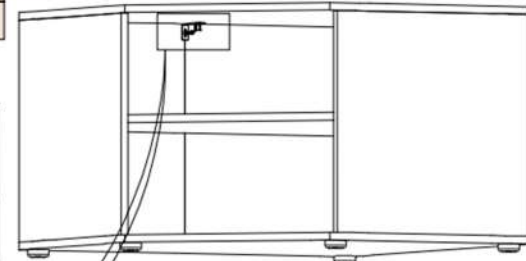
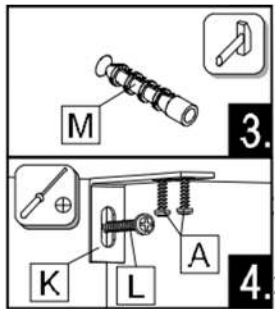
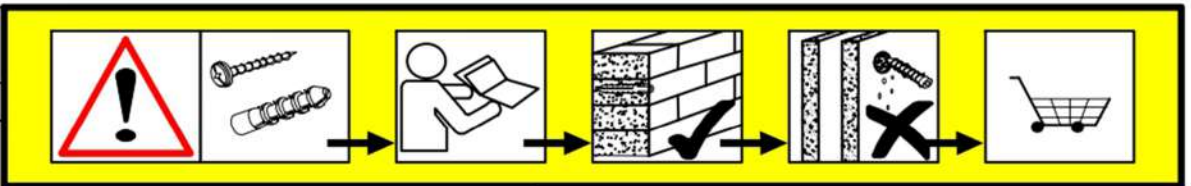

	
Ø3,5*16	
A 2x	K 1x
	
Ø4x70	Ø8
L 1x	M 1x







SI	Pozor! Pred montažo preverite stanje stene. Priloženi univerzalni mozniki so izključno samo za uporabo na čvrstem zidovju, kot sta beton in opeka. Stenski mozniki se ne smejo uporabljati pri zidovju kot so votlino opeka, zidaki za lahko gradnjo, mavčne plošče ali druge okvirne gradnje. Pri teh zidovjih morate v danih primerih uporabljati posebne moznike. Ti so na voljo v specializiranih trgovinah (trgovinah za gradbenim materialom) Pri upoštevanju se s strani proizvajalca/trgovca in uvoznika ne prevzame jamstvo
HR	Pažnja! Prije montaže obvezno provjerite svojstvo zida. Priložene univerzalne tiple namijenjene su isključivo za masivne zidove od betona/opeke. Tiple za masivne zidove ne smiju se koristiti za zidove kao npr šupljina opeka laki sastavni elementi, gips-kartonske ploče ili drugi modularni načini gradnje. Za te zidove potrebne su eventualno specijalne tiple! Iste su dostupne u specijaliziranim trgovinama građevinskim materijalom. U slučaju nepridržavanja prethodno navedenih napomena, proizvođač/trgovac i uvoznik ne preuzimaju odgovornost!

SK	Upozomenie! Pevnosť steny sa musí pred montážou bezpodmienečne skontrolovať. Univerzálne hmoždenky, ktoré sú obsiahnuté v balení, používajte jedine pre pevné murivo ako je betón/tehla. Hmoždenky sa nesmú používať v prípade ľahkého stavebného muriva, dutina tehla, v sádkartónových dosiek alebo iných konštrukcií rámu. U týchto murív je nutné použiť špeciálne hmoždenky! Tieto je možné dostať v špeciálnych predajniach so stavebným materiálom (stavebniny). Pri nedodržaní pokynov nepreberajú výrobcovia/predajci a dodávateľia zodpovednosť za vzniknuté škody.
HU	Vigyázat! Szerelés előtt a falfelületet feltétlenül vizsgálja meg. A mellékelt univerzális tippel kizárólag stabil falazathoz használható mint például beton/tégla. A fali tippel nem használható könnyű építőkövekhez, üreg tégla, gipszkarton lapokhoz vagy más fávázás építményekhez. Ezekhez a falfelületekhez csak speciális tippel használhatóak, melyek szaküzletekben (barkácsáruházakban) beszerezhetőek. Fontelj figyelmen kívül hagyása esetén a gyártó/kereskedő vagy forgalmazó nem vállal felelősséget.
CZ	Upozornění! Před montáží je nutné zkontrolovat stav stěny. Přiložené univerzální hmoždinky jsou určeny pouze k použití pro pevné zdvo jako beton/cihly. Hmoždinky do zdi se nesmí používat u dutinová cihla, zdvo jako pórovitý stavební kámen, sádkartónová deska nebo jiný měkký materiál. U těchto zdív jsou nutné použít speciální hmoždinky! Jsou k dostání v speciálních prodejních se stavebním materiálem. Při nedodržení těchto pokynů výrobce/prodejce a dovozce neručí za způsobené škody.
RO	Prudentă! Zidul trebuie examinat înainte de asamblare prizele de perete sunt adecvatenumai pentru utilizarea în zidărie fermă, cum ar fi betonul bloc sau cărămidă. Nu folosiți zidăria zidurilor de perete, cum ar fi caramida goală, blocul ușor, suprafețe cum ar fi gips-carton sau altă încadrare sisteme. Dacă este cazul, trebuie folosite anumite prizele de perete! Acestea sunt disponibile la un magazin specializat (magazin de hardware). În caz de nerespectare, producătorul / vânzătorul cu amănuntul sau importatorul nu își asumă răspunderea.

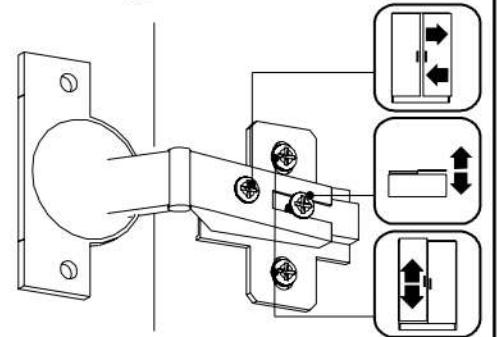
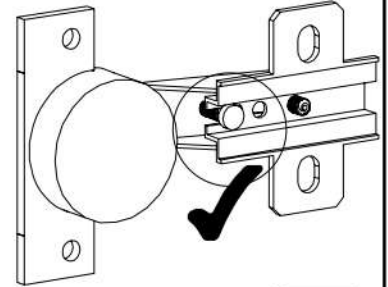
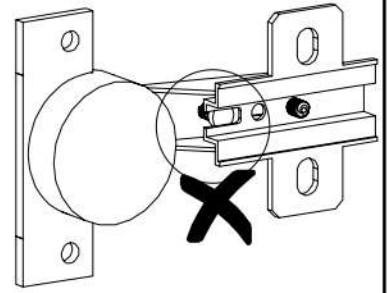
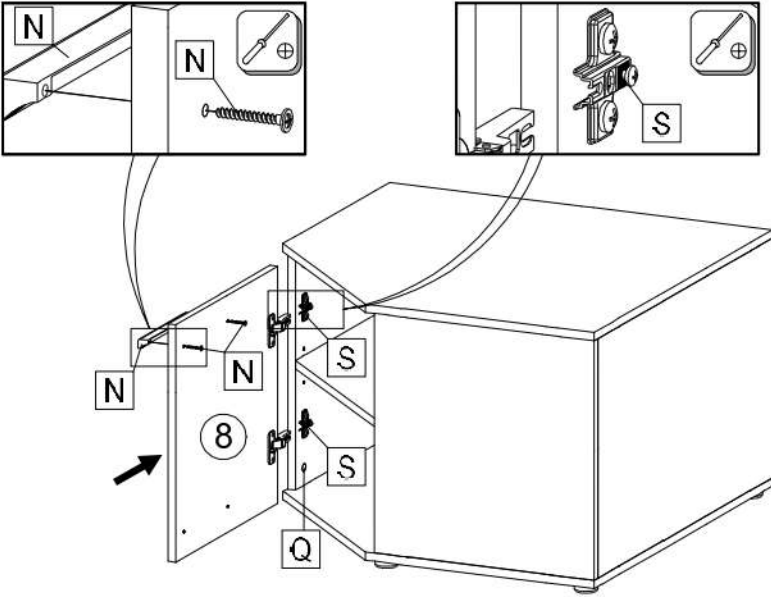
		
N 1x	Q 12x	S 2x

A



		
N 1x	Q 12x	S 2x

B

