

SK/ NÁVOD NA MONTÁŽ
 CZ/ MONTÁŽNÍ NÁVOD
 HU/ SZERELÉSI UTASÍTÁS
 HR/ UPUTE ZA UGRADNJU
 RO/ INSTRUCTIUNI DE INSTALARE
 SI/ NAVODILA ZA MONTAŽO

DUNAJ TYP 8

	900	mm
	508	
	470	



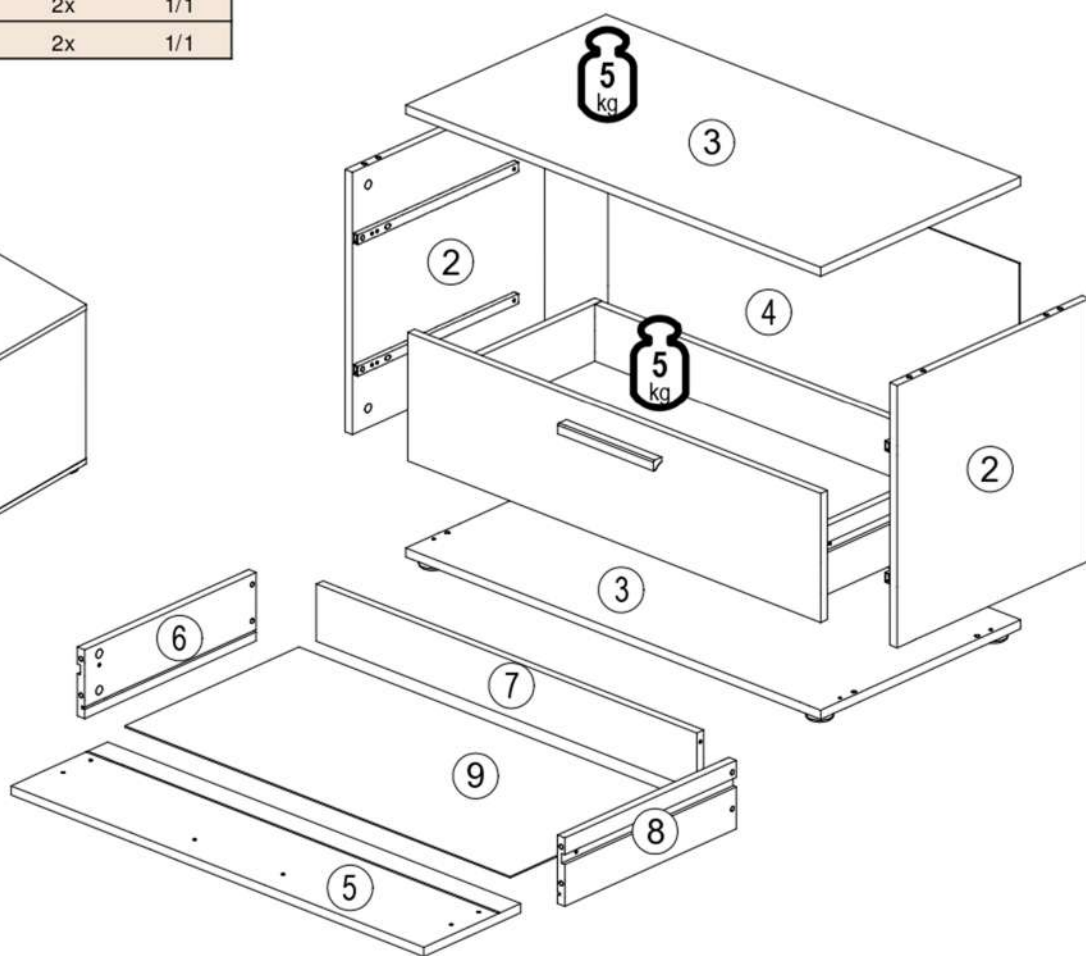

	 60 min		 PZ 2	 ≤ 0,5 kg	 3m	 4
--	------------	--	----------	--------------	--------	-------

ID	ID			
12728	②	460*449*16	2x	1/1
12729	③	900*467*16	2x	1/1
16488	④	486*892*3	1x	1/1
12730	⑤	896*226*16	2x	1/1
12271	⑥	400*120*16	2x	1/1
12731	⑦	826*100*16	2x	1/1
07408	⑧	400*120*16	2x	1/1
12732	⑨	836*406*3	2x	1/1



 22244,01 Ø3.5*16	 27000,00 Ø8*30	 70013,01	 70021,01	 22705,00 Ø6.3x8	 30080,00 Ø44x15	 21102,00 Ø1.2x20	 22300,00 Ø7x50	 22250,00 Ø4x25	 31103,00
A 18x	B 8x	C 16x	D 16x	E 12x	F 4x	G 50x	H 8x	J 4x	K 1x
 22213,00 Ø4x70	 24103,00 Ø8	 32315,00	 22601,00	 50553,00	 22502,00 M4x12	 33018,00			
L 1x	M 1x	N 2x	P 2x	Q 16x	R 8x	S 4x	T 2x		



				
B 8x	C 16x	D 16x	E 12x	T 2x

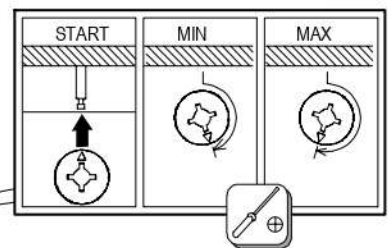
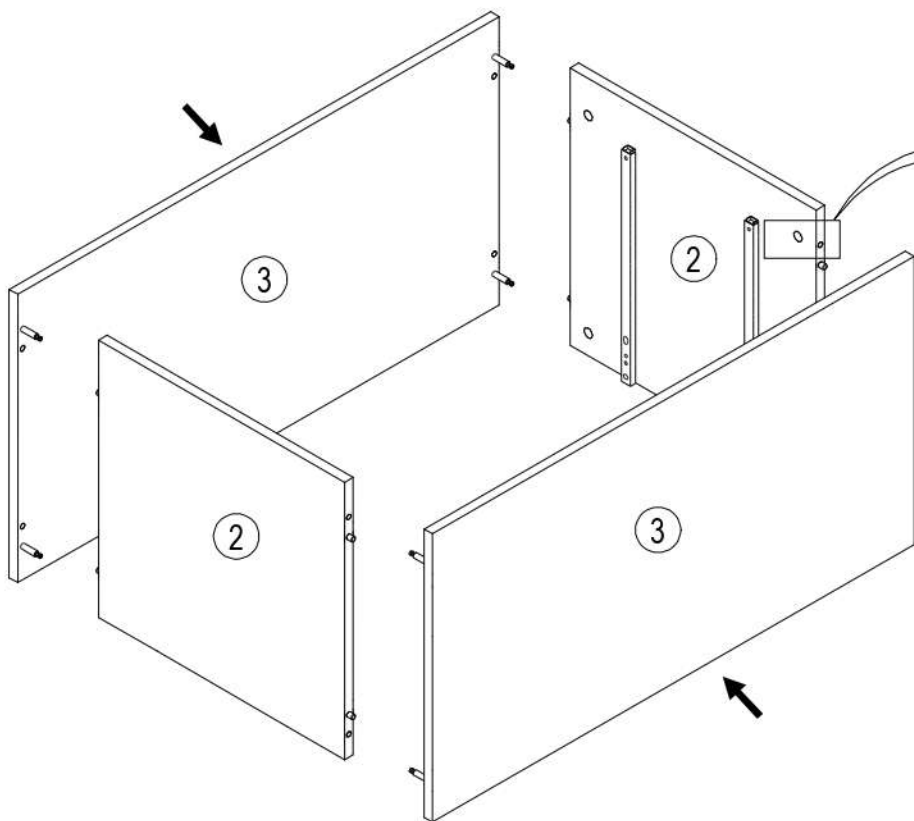
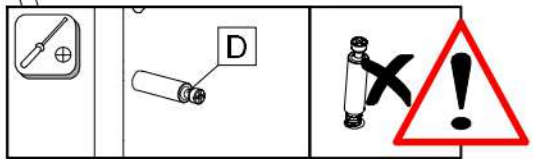
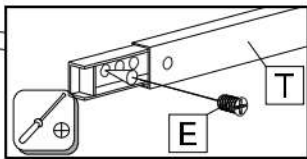
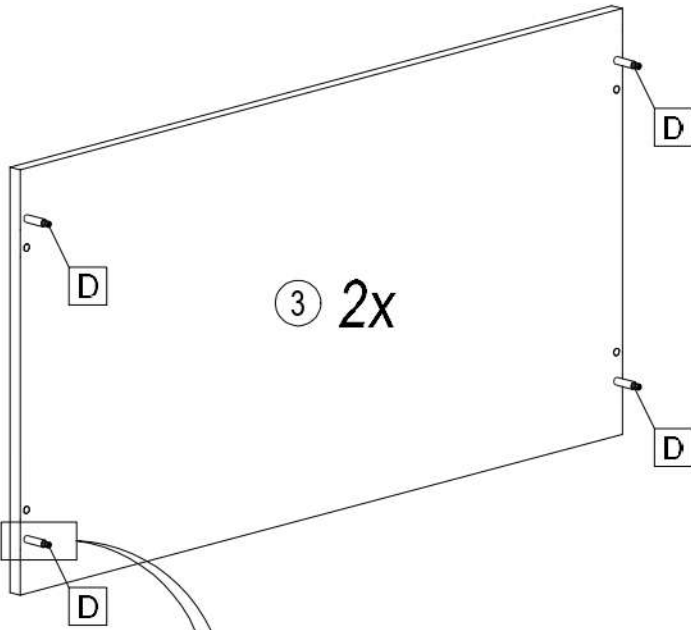
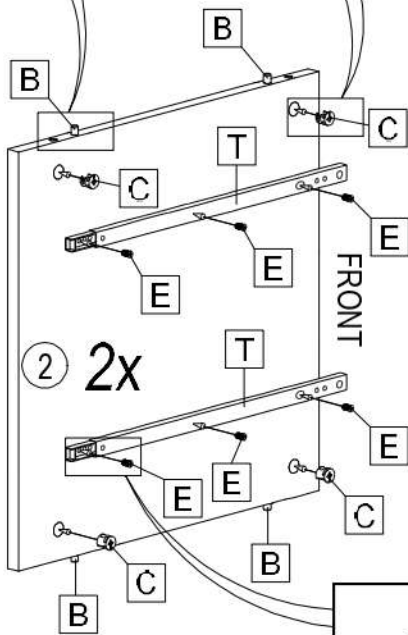
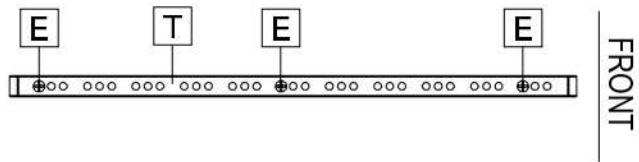
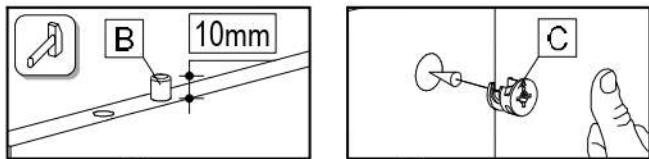

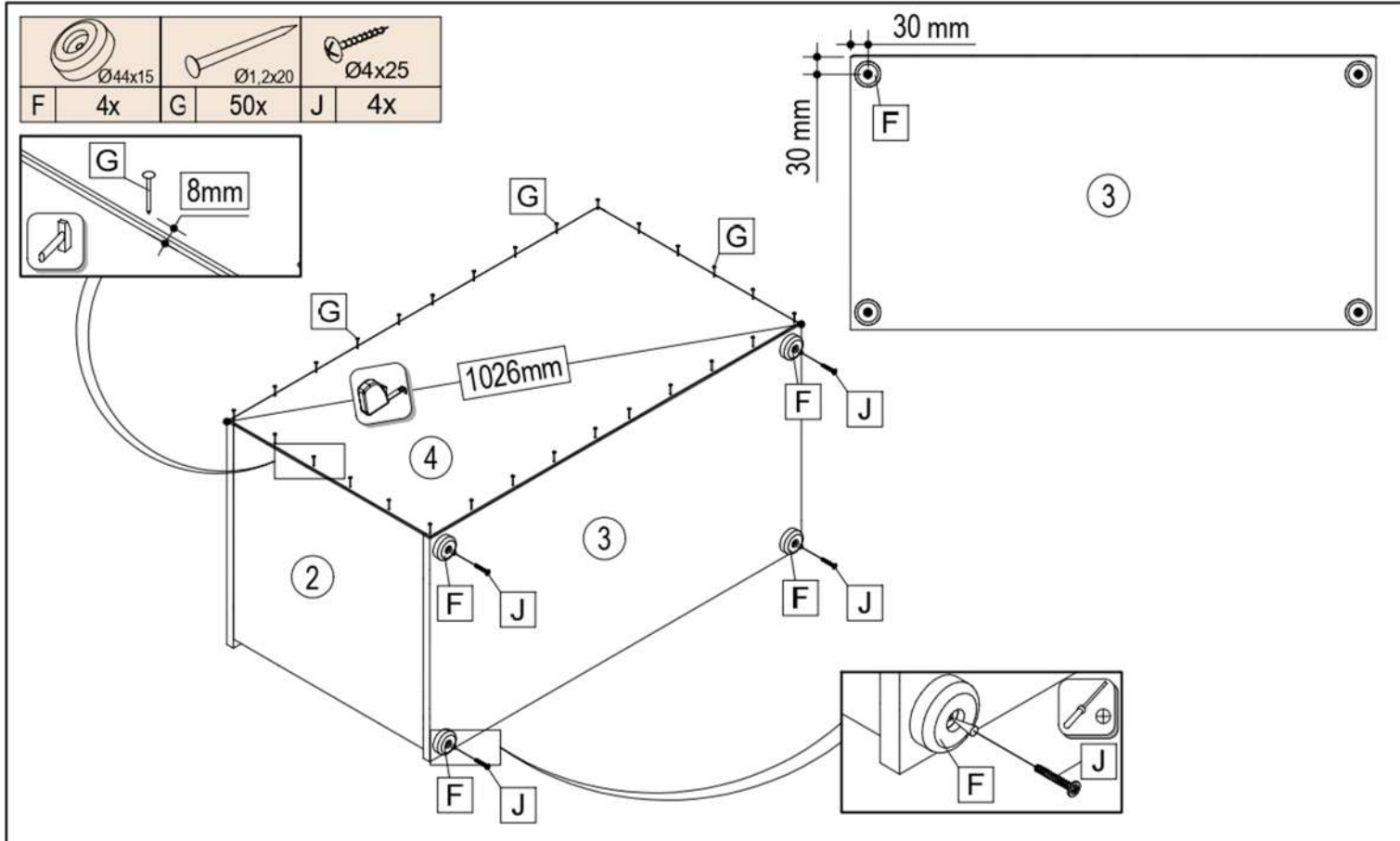





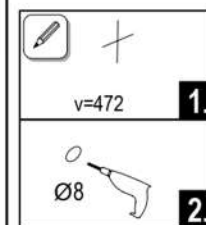



A 2x	K 1x	
L 1x	M 1x	

SI	<p>Pozor! Pred montažo preverite stanje stene. Priloženi univerzalni mozniki so izključno samo za uporabo na čvrstem zidovju, kot sta beton in opeka. Stenski mozniki se ne smejo uporabljati pri zidovju kot so votlina opeke, zidaki za lahko gradnjo, mavčne plošče ali druge okvirne gradnje. Pri teh zidovjih morate v danih primerih uporabljati posebne moznike. Ti so na voljo v specializiranih trgovinah (trgovinah z gradbenim materialom) Pri upoštevanju se s strani proizvajalca/trgovca in uvoznika ne prevzame jamstvo</p>	HR	<p>Pažnja! Prije montaže obvezno provjerite svojstvo zida. Priložene univerzalne tiple namijenjene su isključivo za masivne zidove od betona/opeke. Tiple za masivne zidove ne smiju se koristiti za zidove kao npr šupljina opeka laki sastavni elementi, gips-kartonske ploče ili drugi modularni načini gradnje. Za te zidove potrebne su eventualno posebne tiple! Iste su dostupne u specijaliziranim trgovinama građevinskim materijalom. U slučaju nepridržavanja prethodno navedenih napomena, proizvođač/trgovac i uvoznik ne preuzimaju odgovornost!</p>
RO	<p>Prudență! Zidul trebuie examinat înainte de asamblare prizele de perete sunt adecvatenumai pentru utilizarea în zidărie fermă, cum ar fi betonul bloc sau cărămidă. Nu folosiți zidăria zidurilor de perete, cum ar fi caramida goală, blocul ușor, suprafețe cum ar fi gips-carton sau altă încadrare sisteme. Dacă este cazul, trebuie folosite anumite prizele de perete! Acestea sunt disponibile la un magazin specializat (magazin de hardware). În caz de nerespectare, producătorul / vânzătorul cu amănuntul sau importatorul nu își asumă răspunderea.</p>	SK	<p>Upozornenie! Pevnosť steny sa musí pred montážou bezpodmienečne skontrolovať. Univerzálne hmoždenky, ktoré sú obsiahnuté v balení, používajte jedine pre pevné murivo ako je betón/tehla. Hmoždenky sa nesmú používať v prípade ľahkého staveného muriva, dutina tehla, u sádkartónových dosiek alebo iných konštrukcií rámu. U týchto murív je nutné použiť špeciálne hmoždenky! Tieto je možné dostať v špeciálnych predajniach so stavebným materiálom (stavebniny). Pri nedodržíaní pokynov nepreberajú výrobcovia/predajci a dodávateľa zodpovednosť za vzniknuté škody.</p>
HU		HU	<p>Vigyázat! Szerelés előtt a falfelületet feltétlenül vizsgálja meg. A mellékelt univerzális tiplik kizárólag stabil falazathoz használható mint például beton/tégla. A fal tiplik nem használható könnyű építőkövekhez, üreg tégla, gipszkarton lapokhoz vagy más fávázás építményekhez. Ezekhez a falfelületekhez csak speciális tiplik használhatóak, melyek szaküzletekben (barkácsruházakban) beszerezhetőek. Fentiek figyelmen kívül hagyása esetén a gyártó/kereskedő vagy forgalmazó nem vállal felelősséget.</p>
CZ		CZ	<p>Upozornění! Před montáží je nutné zkontrolovat stav stěny. Přiložené univerzální hmoždinky jsou určeny pouze k použití pro pevné zdivo jako beton/cihly. Hmoždinky do zdi se nesmí používat u dutinová cihla, zdiva jako pórovitý stavební kámen, sádkartónová deska nebo jiný měkký materiál. U těchto zdív jsou nutné použít speciální hmoždinky! Jsou k dostání v speciálních prodejnách se stavebním materiálem. Při nedodržení těchto pokynů výrobce/prodejce a dovozece neručí za způsobené škody.</p>

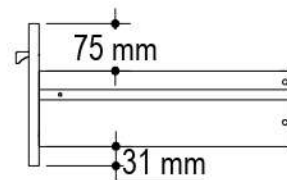
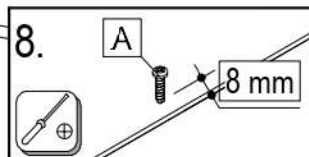
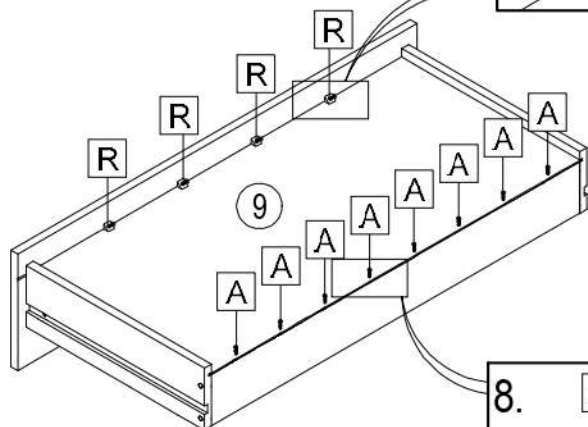
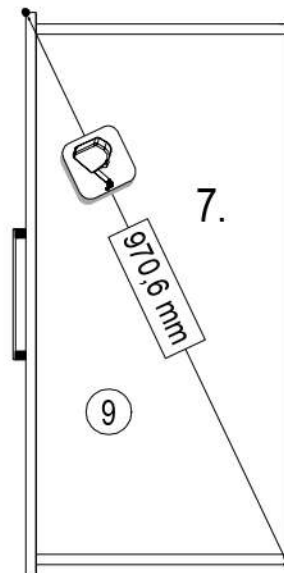
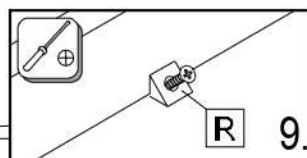
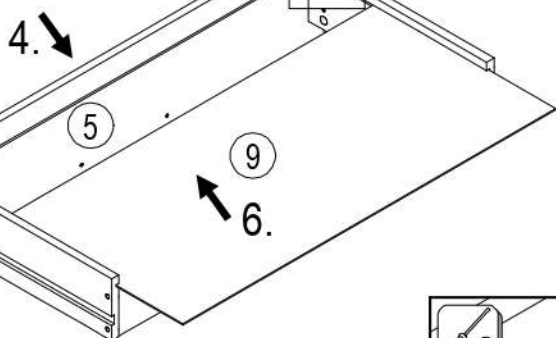
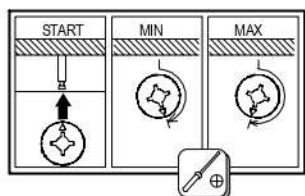
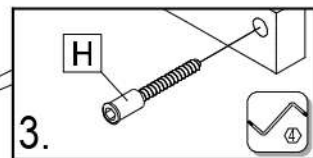
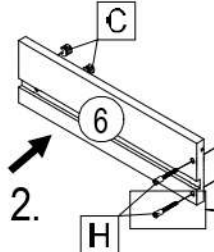
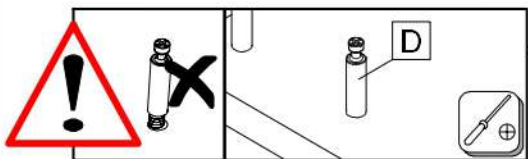
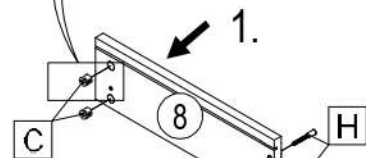
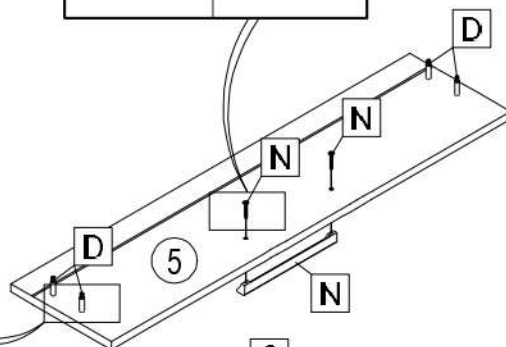
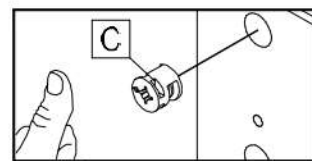
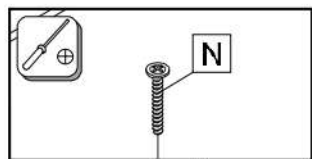
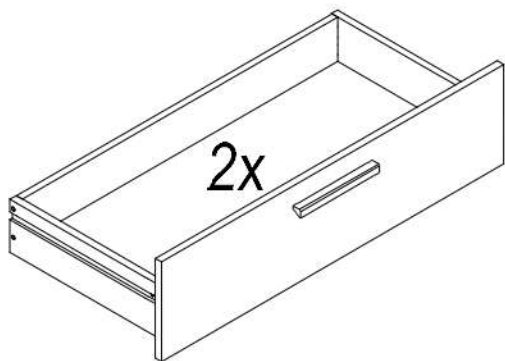

					
A 16x	C 8x	D 8x	H 8x	N 2x	R 8x



		M4x12	
Q	8x	S	4x

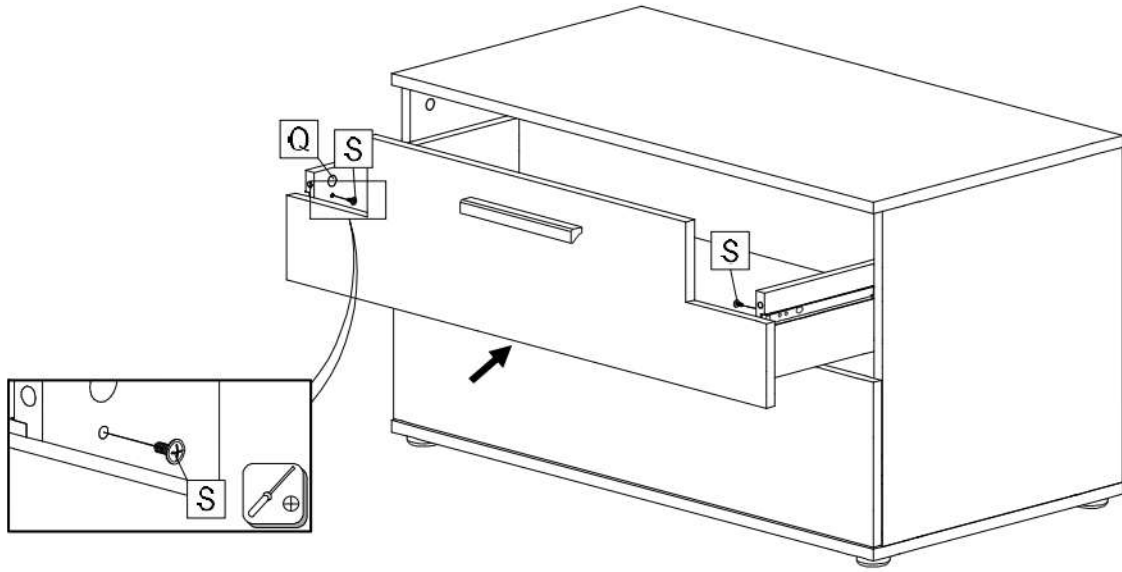

	P	2x
--	---	----

