

SK/ NÁVOD NA MONTÁŽ
 CZ/ MONTÁŽNÍ NÁVOD
 HU/ SZERELÉSI UTASÍTÁS
 HR/ UPUTE ZA UGRADNJU
 RO/ INSTRUCTIUNI DE INSTALARE
 SI/ NAVODILA ZA MONTAŽO

DUNAJ TYP 1

	900	mm
	1908	
	470	

	 80 min		 PZ 2	 ≤ 0,5 kg	 3m
--	------------	--	----------	--------------	--------



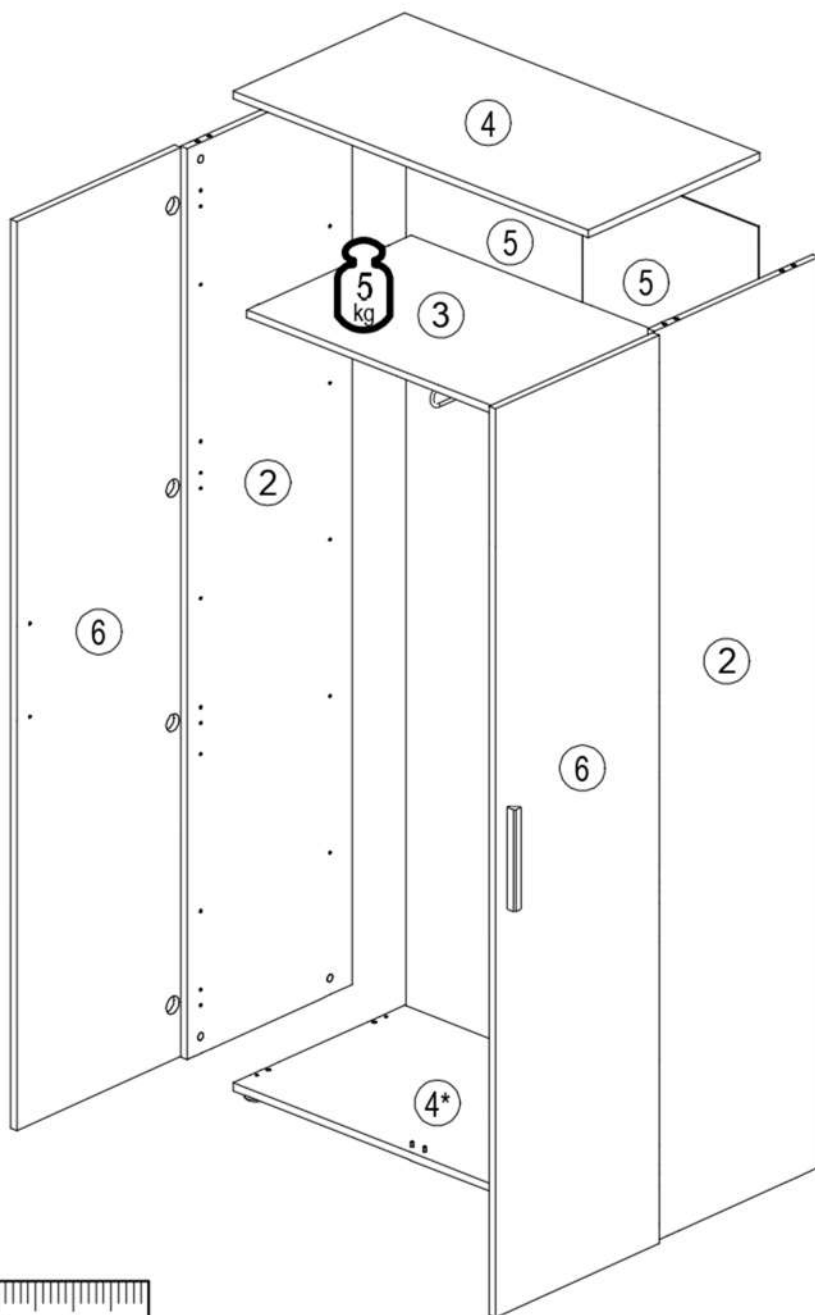
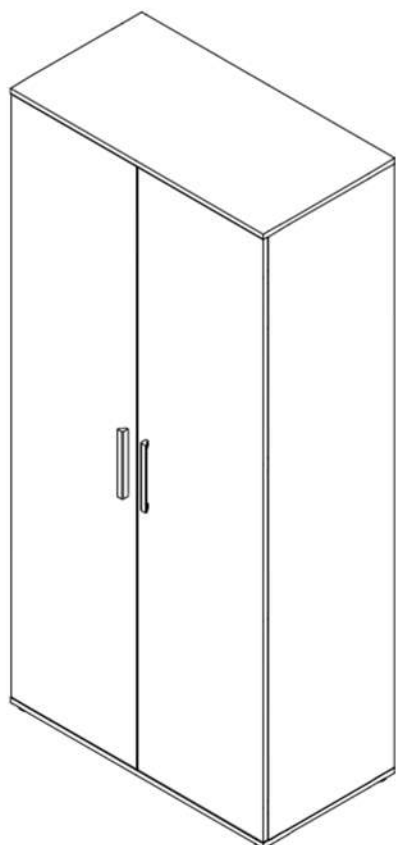



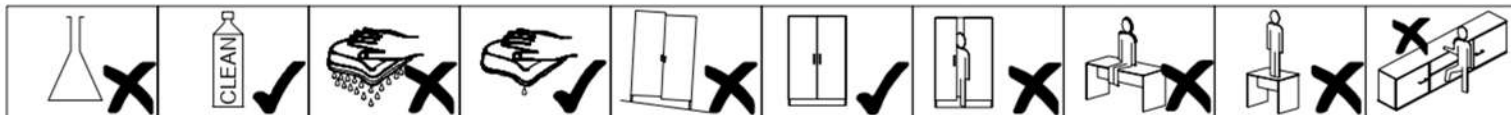

ID	ID			
12681	②	1860*449*16	2x	1/2
12682	③	866*448*16	1x	2/2
12683	④	900*467*16	2x	2/2
12684	⑤	1886*446*2,5	2x	1/2
12685	⑥	1856*446*16	2x	1/2





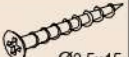

 Ø3.5*16	 Ø8*30	 70013,01	 70021,01	 35102,00	 30080,00 Ø44x15	 Ø1.2x20	 Ø3.5x15	 Ø4x25	
A 6x	B 8x	C 12x	D 12x	E 4x	F 4x	G 75x	H 16x	J 4x	K 1x

 Ø4x70	 Ø8							
L 1x	M 1x	N 2x	P 2x	Q 12x	R 8x	S 8x	T 1x	✓

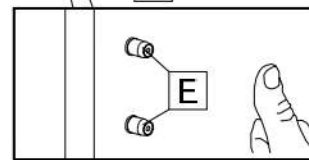
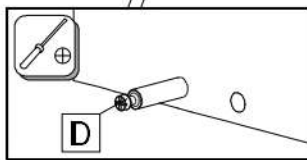
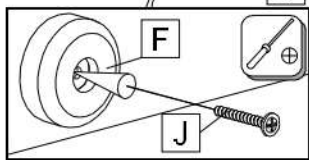
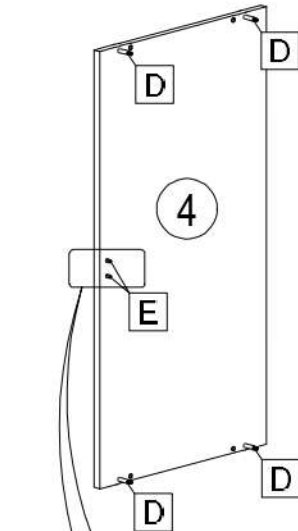
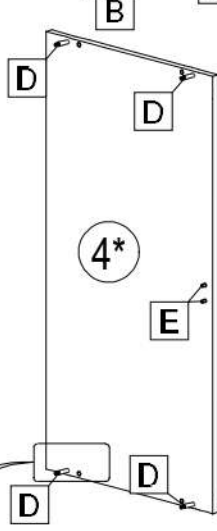
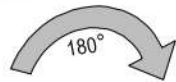
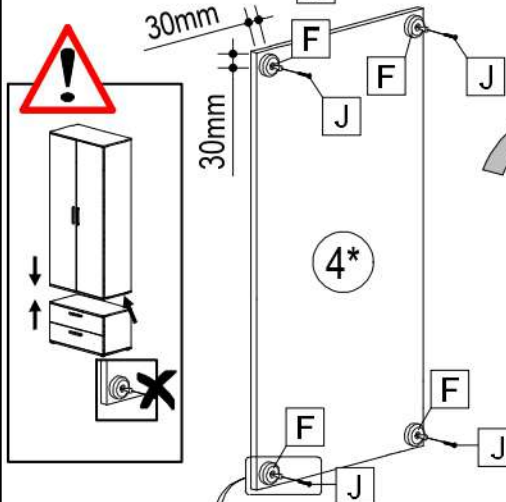
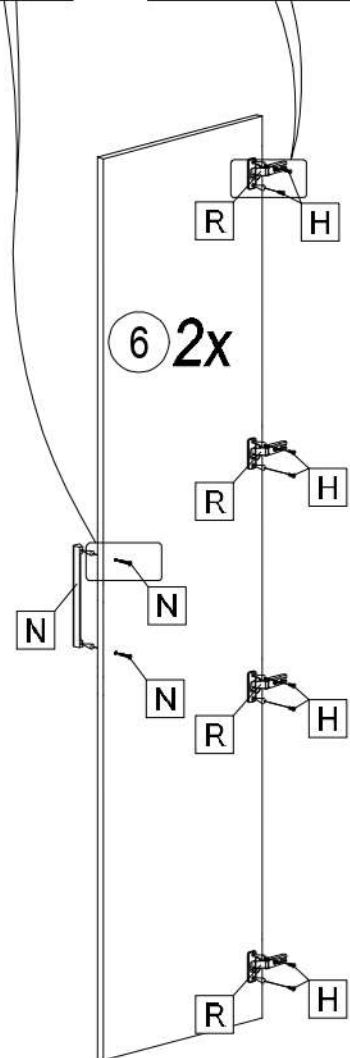
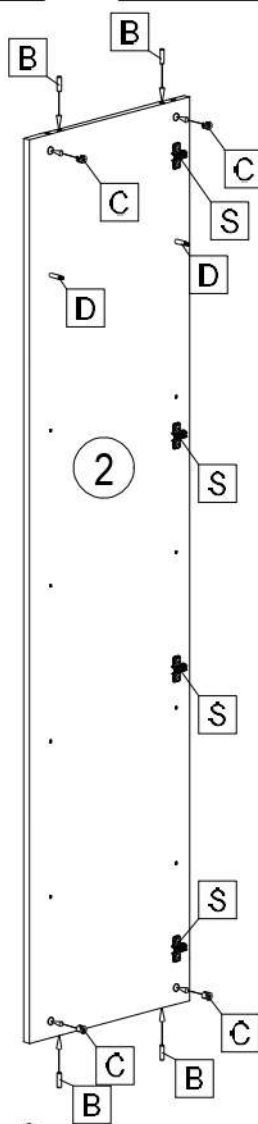
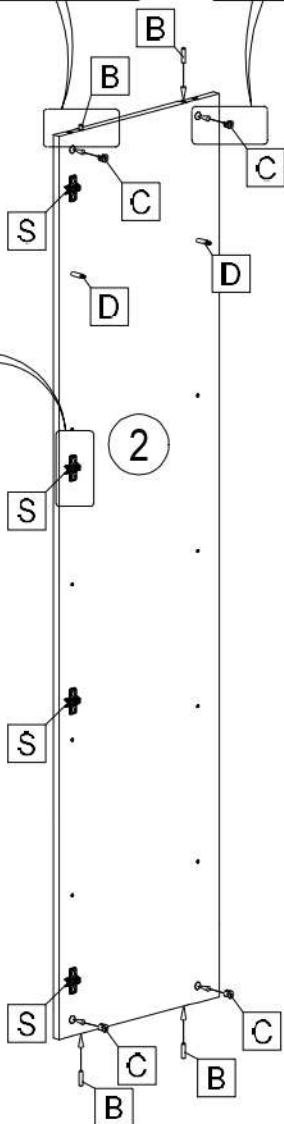
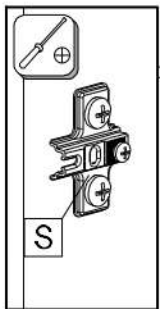
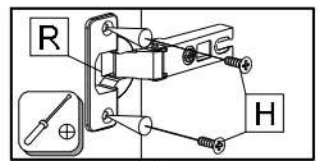
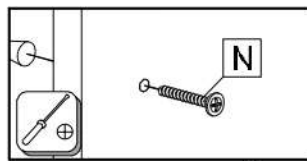
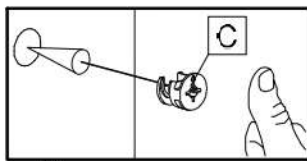
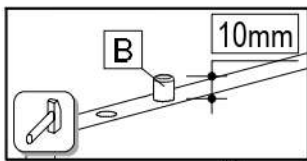

									
B 8x	C 8x	D 12x	E 4x	F 4x	H 16x	J 4x	N 2x	R 8x	S 8x



		
Ø3.5*16		
A 4x	C 4x	T 1x

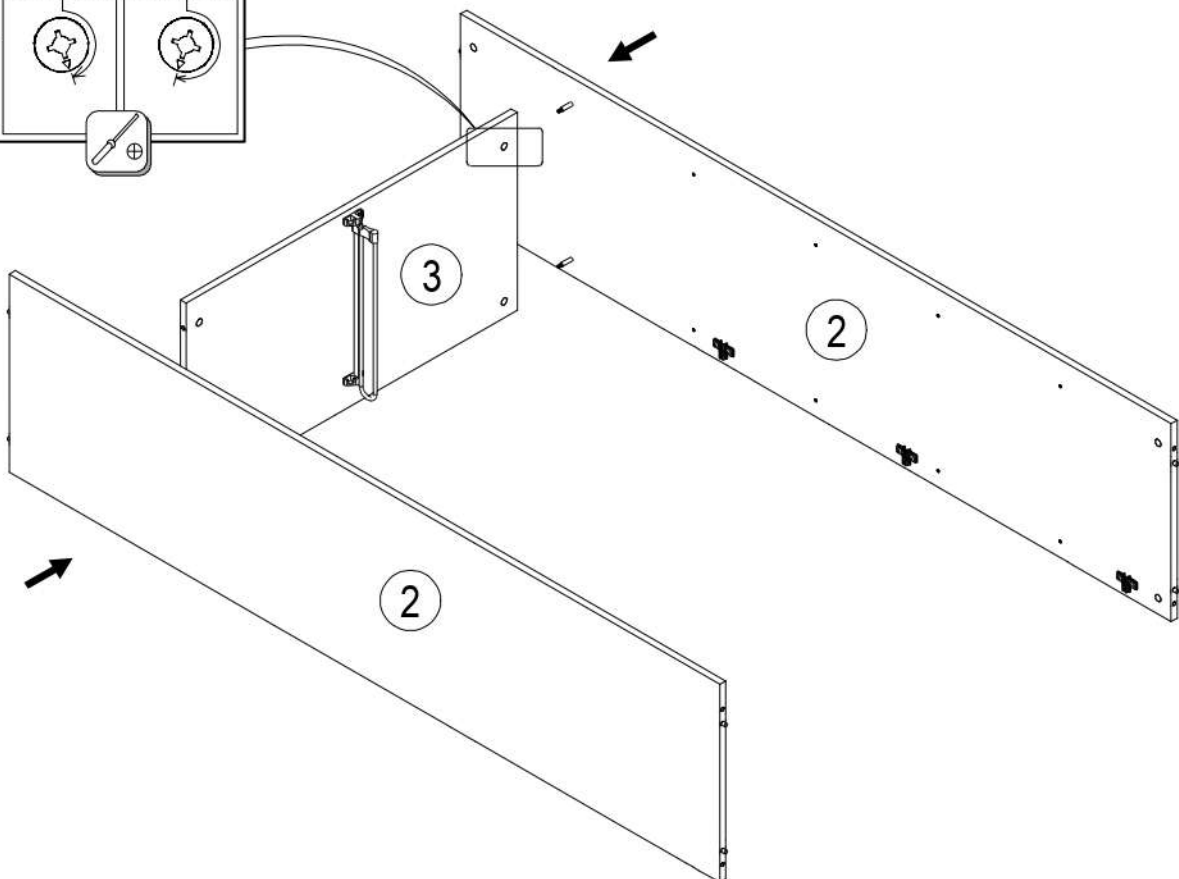
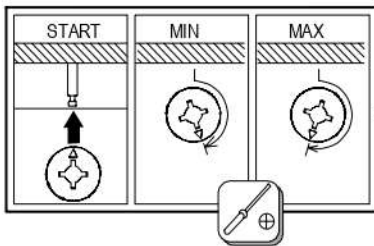
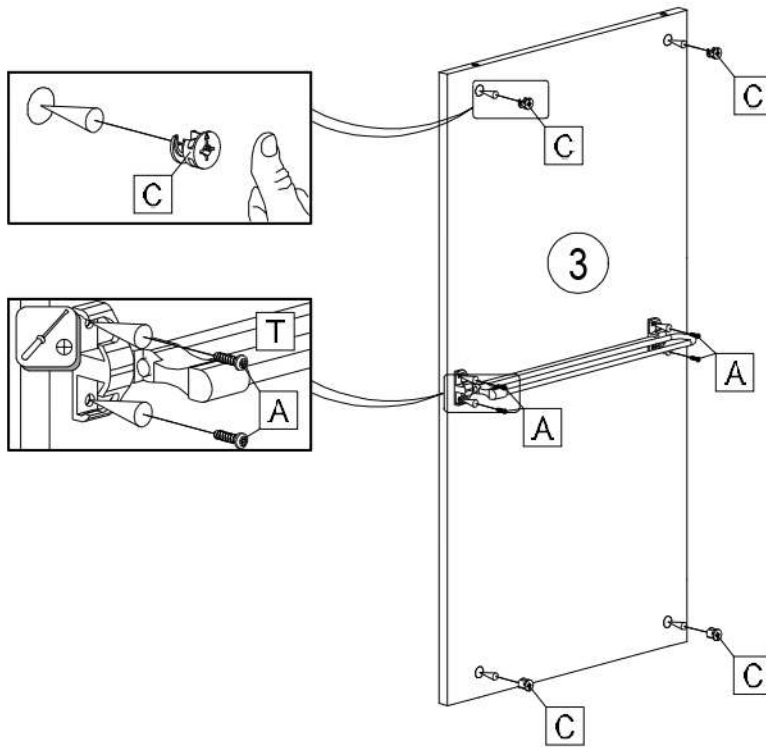

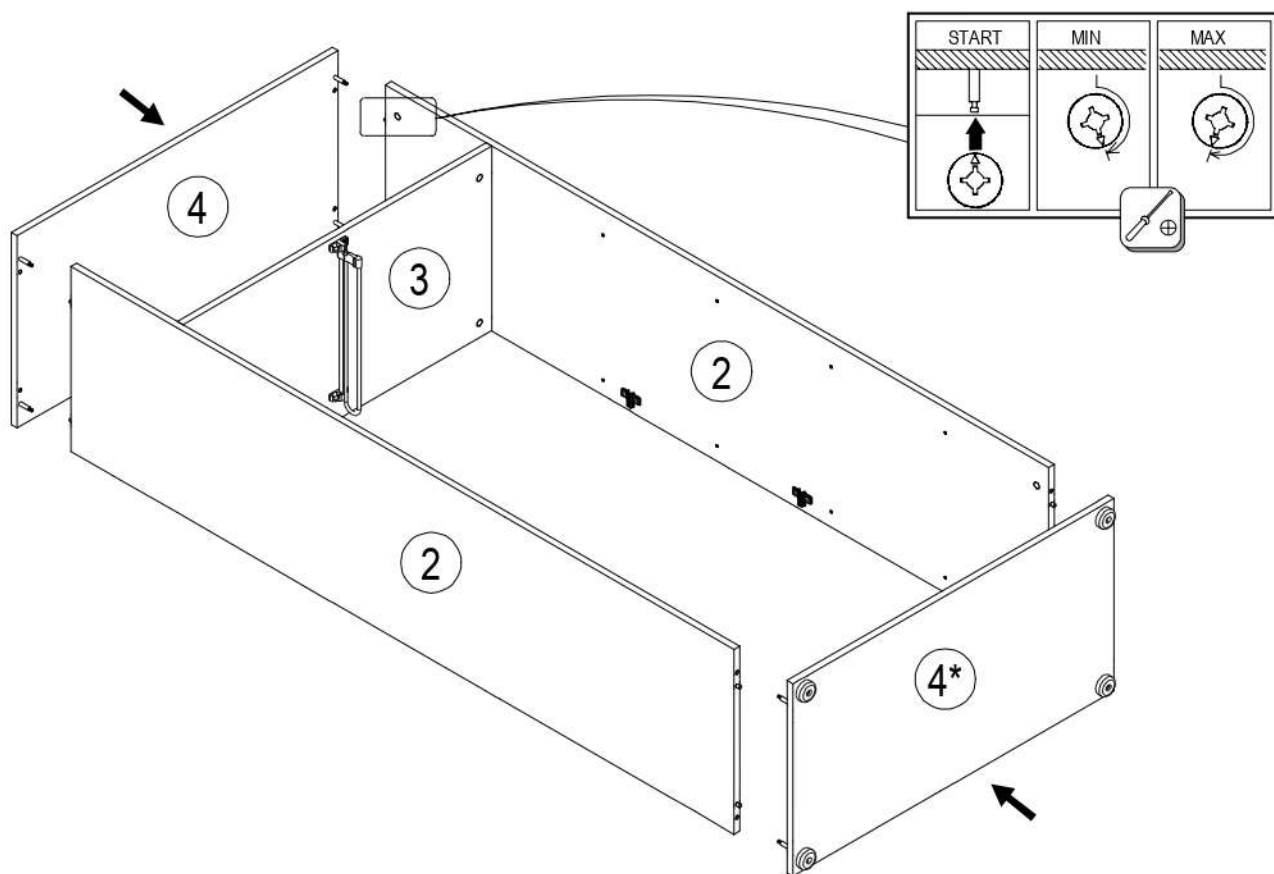

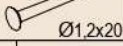
	Ø1,2x20
G	75x

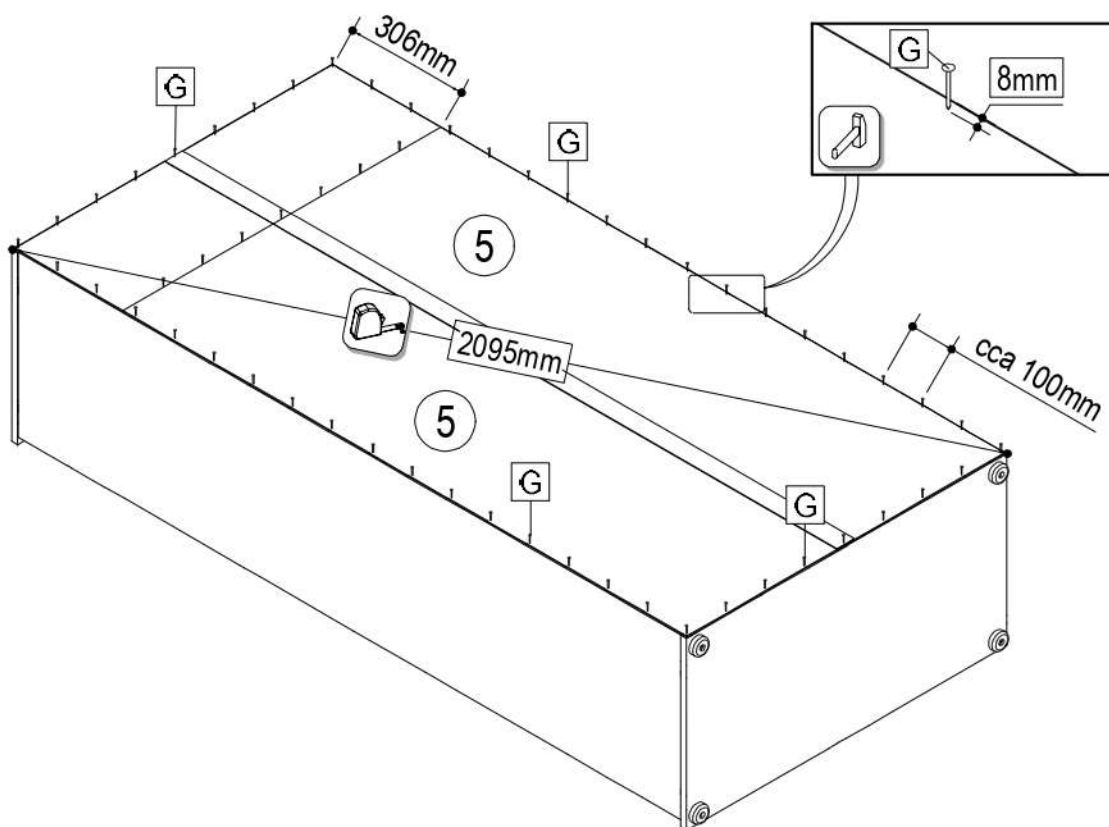

	Ø3.5x16		1x
A	2x	K	1x
	Ø4x70		Ø8
L	1x	M	1x

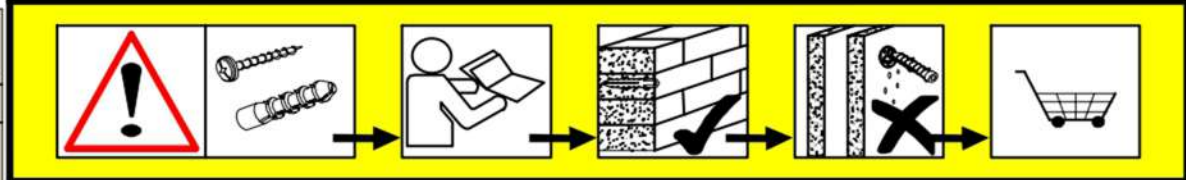

v=1872 **1.**

Ø8 **2.**

M **3.**

K A **4.**

L K **5.**

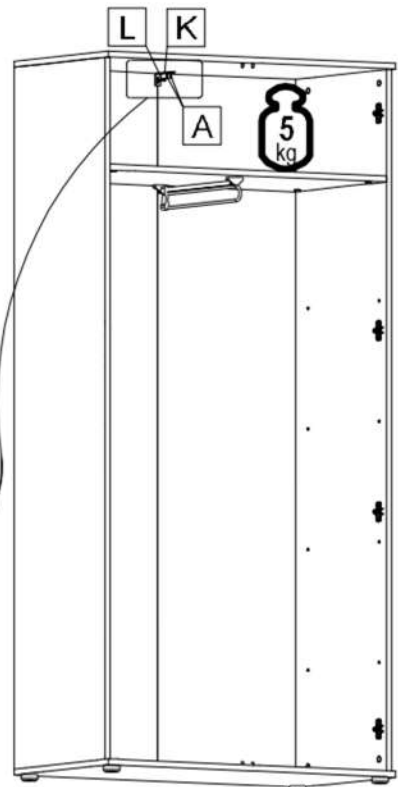

SK
 Upozornenie! Pevnosť steny sa musí pred montážou bezpodmienečne skontrolovať. Univerzálne hmoždenky, ktoré sú obsiahnuté v balení, používajte jedine pre pevné murivo ako je betón/tehla. Hmoždenky sa nesmú používať v prípade ľahkého stavebného muriva, dutina tehla, u sádkartónových dosiek alebo iných konštrukcií rámu. U týchto murív je nutné použiť špeciálne hmoždenky! Tieto je možné dostať v špeciálnych predajniach so stavebným materiálom (stavebniny). Pri nedodržaní pokynov nepreberajú výrobcovia/predajci a dodávateľa zodpovednosť za vzniknuté škody.

HU
 Vigyázat! Szerelés előtt a falfelületet feltétlenül vizsgálja meg. A mellékelt univerzális tiplel kizárólag stabil falazathoz használható mint például beton/tegla. A fal tiplel nem használható könnyű építőkövekhez, üreg tégla, gipszkarton lapokhoz vagy más favázás építményekhez. Ezekhez a falfelületekhez csak speciális tiplek használhatóak, melyek szaküzletekben (barkácsruházakban) beszerezhetőek. Fentiek figyelmen kívül hagyása esetén a gyártó/kereskedő vagy forgalmazó nem vállal felelősséget.

CZ
 Upozornění! Před montáží je nutné zkontrolovat stav stěny. Příložené univerzální hmoždinky jsou určeny pouze k použití pro pevné zdivo jako beton/cihly. Hmoždinky do zdi se nesmí používat u dutinová cihla, zdiva jako pórovitý stavební kámen, sádkartónová deska nebo jiný měkký materiál. U těchto zdív jsou nutné použít speciální hmoždinky! Jsou k dostání v speciálních prodejních se stavebním materiálem. Při nedodržení těchto pokynů výrobce/prodejece a dovozce neručí za způsobené škody.

RO
 Prudență! Zidul trebuie examinat înainte de asamblare prizele de perete sunt adecvatenumai pentru utilizarea în zidărie fermă, cum ar fi betonul bloc sau cărămidă. Nu folosiți zidăria zidurilor de perete, cum ar fi caramida goală, blocul ușor, suprafețe cum ar fi gips-carton sau altă încadrare sisteme. Dacă este cazul, trebuie folosite anumite prize de perete! Acestea sunt disponibil la un magazin specializat (magazin de hardware) . În caz de nerespectare, producătorul / vânzătorul cu amănuntul sau importatorul nu își asumă răspunderea.

SI
 Pozor! Pred montažo preverite stanje stene. Priloženi univerzalni mozniki so izključno samo za uporabo na čvrstem zidovju, kot sta beton in opeka. Stenski mozniki se ne smejo uporabljati pri zidovju kot so votlina opeke, zidaki za lahko gradnjo, mavčne plošče ali druge okvirne gradnje. Pri teh zidovjih morate v danih primerih uporabljati posebne moznike. Ti so na voljo v specializiranih trgovinah (trgovinah z gradbenim materialom) Pri upoštevanju se s strani proizvajalca/trgovca in uvoznika ne prevzame jamstvo

HR
 Pažnja! Prije montaže obavezno provjerite svojstvo zida. Priložene univerzalne tiple namijenjene su isključivo za masivne zidove od betona/opeke. Tiple za masivne zidove ne smiju se koristiti za zidove kao npr šupljina opeka laki sastavni elementi, gips-kartonske ploče ili drugi modulami načini gradnje. Za te zidove potrebne su eventualno specijalne tiple! Iste su dostupne u specijaliziranim trgovinama građevinskim materijalom. U slučaju nepridržavanja prethodno navedenih napomena, proizvođač/trgovac i uvoznik ne preuzimaju odgovornost!

