

SK NÁVOD NA MONTÁŽ
 CZ MONTÁŽNÍ NÁVOD
 HU SZERELÉSI UTASÍTÁS
 DE MONTAGEANLEITUNG

SIPANI NEW

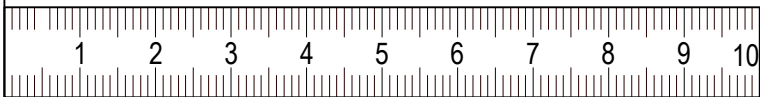
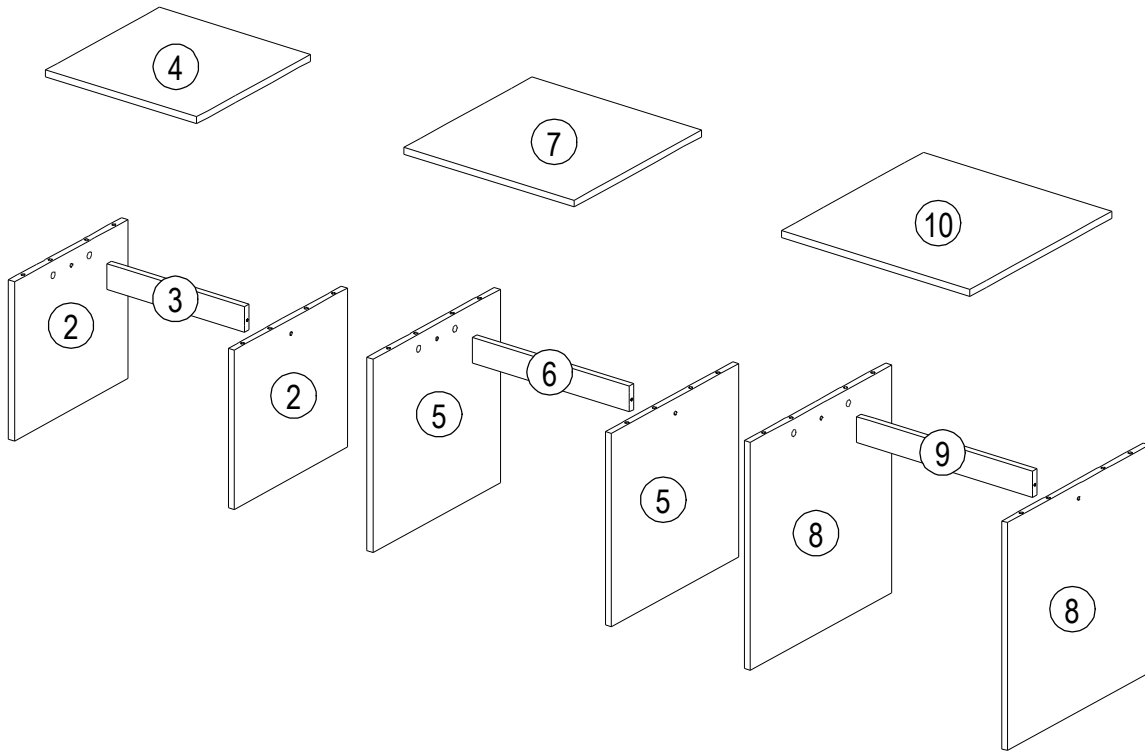
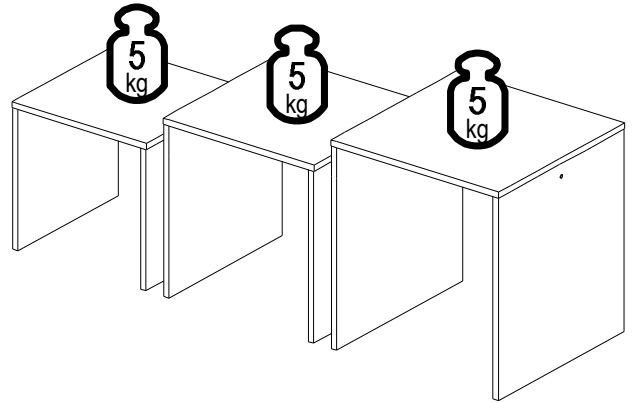

| | | |
|--|-----|----|
| | 500 | mm |
| | 546 | |
| | 500 | |

| ID | Icon | Part No. | Dimensions | Qty | Ratio |
|-------|------|----------|------------|-----|-------|
| 12502 | | 2 | 370*398*16 | 2x | 1/1 |
| 12503 | | 3 | 366*60*16 | 1x | 1/1 |
| 12504 | | 4 | 400*400*16 | 1x | 1/1 |
| 12505 | | 5 | 450*448*16 | 2x | 1/1 |
| 12506 | | 6 | 416*60*16 | 1x | 1/1 |
| 12507 | | 7 | 450*450*16 | 1x | 1/1 |
| 12508 | | 8 | 530*498*16 | 2x | 1/1 |
| 12509 | | 9 | 466*60*16 | 1x | 1/1 |
| 12510 | | 10 | 500*500*16 | 1x | 1/1 |



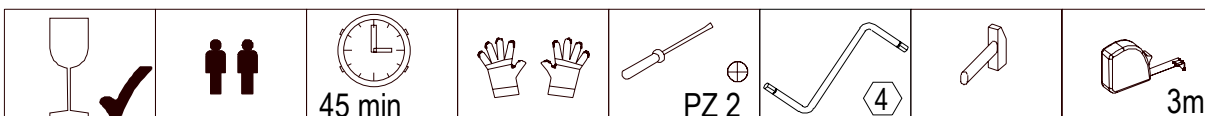

| | | | | | | | | | | | | | |
|----------|-----|----------|----|----------|-----|----------|-----|----------|-----|---|-----|---|----|
| 30090,00 | | 22300,00 | | 27000,00 | | 70013,01 | | 70021,01 | | | | | |
| A | 12x | B | 6x | C | 12x | D | 12x | E | 12x | F | 12x | G | 6x |

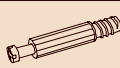

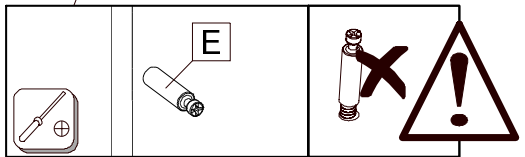
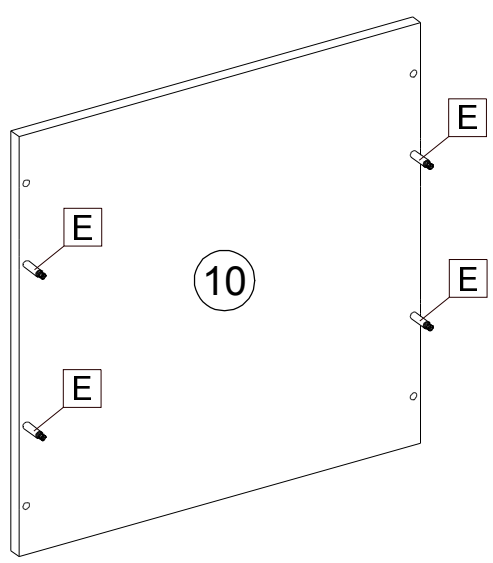
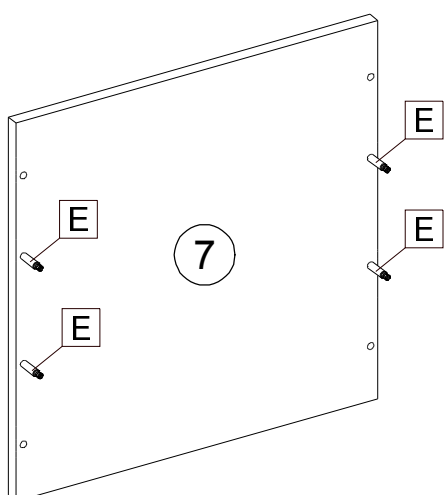
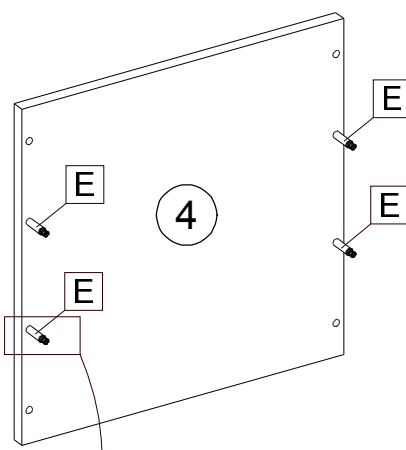
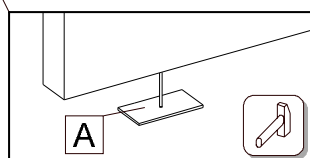
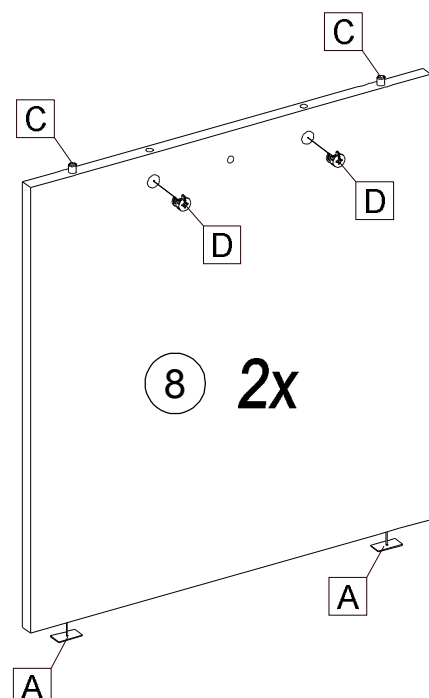
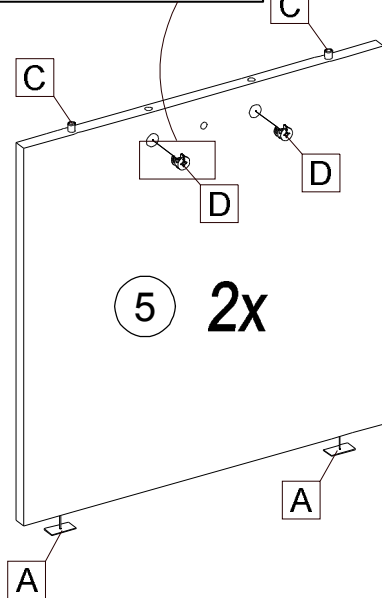
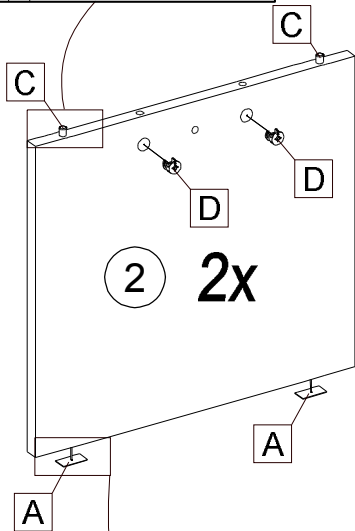
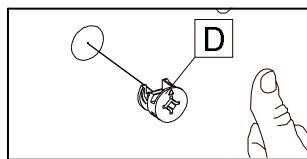
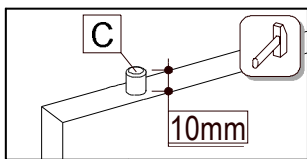

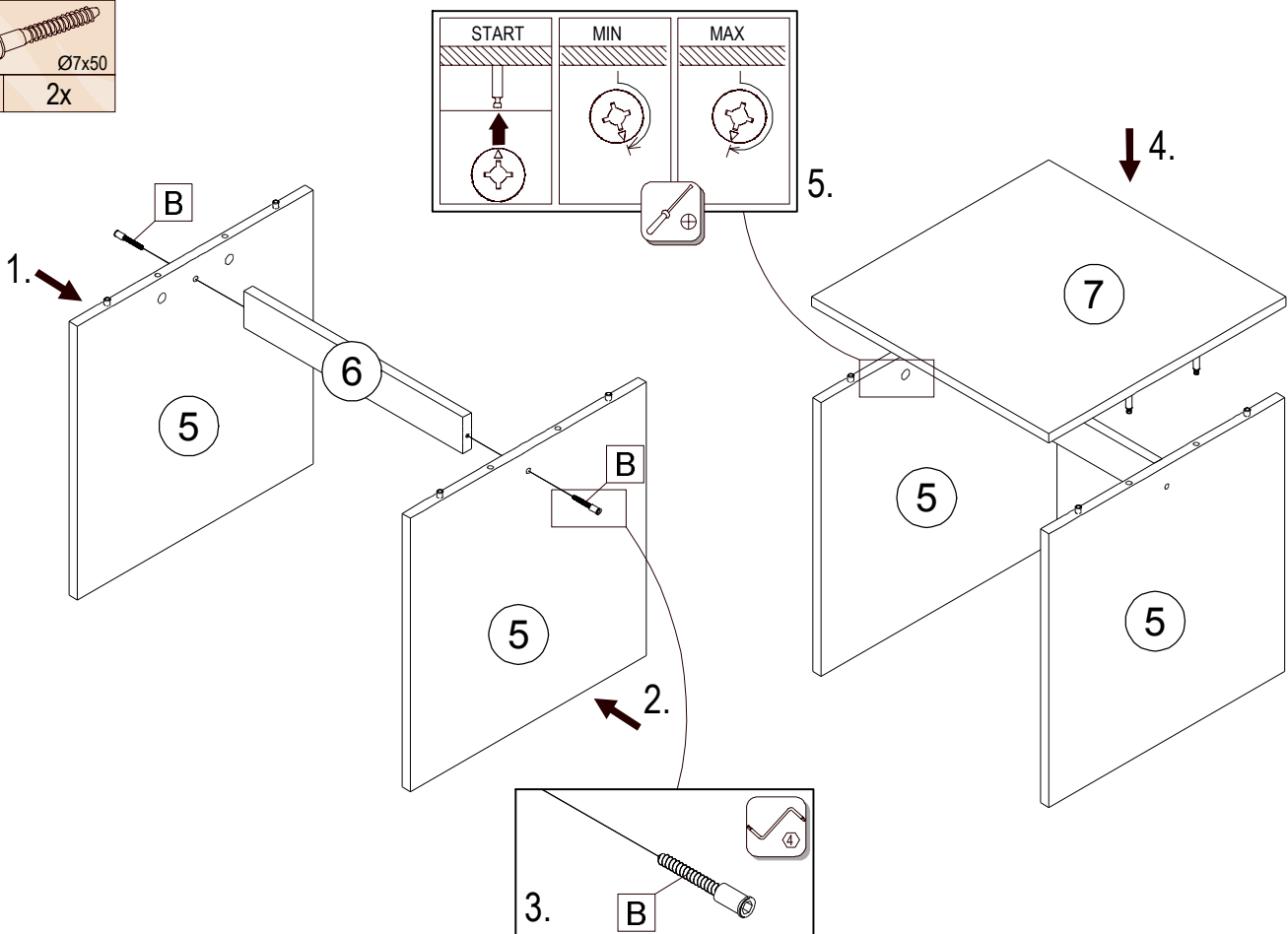
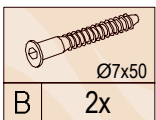
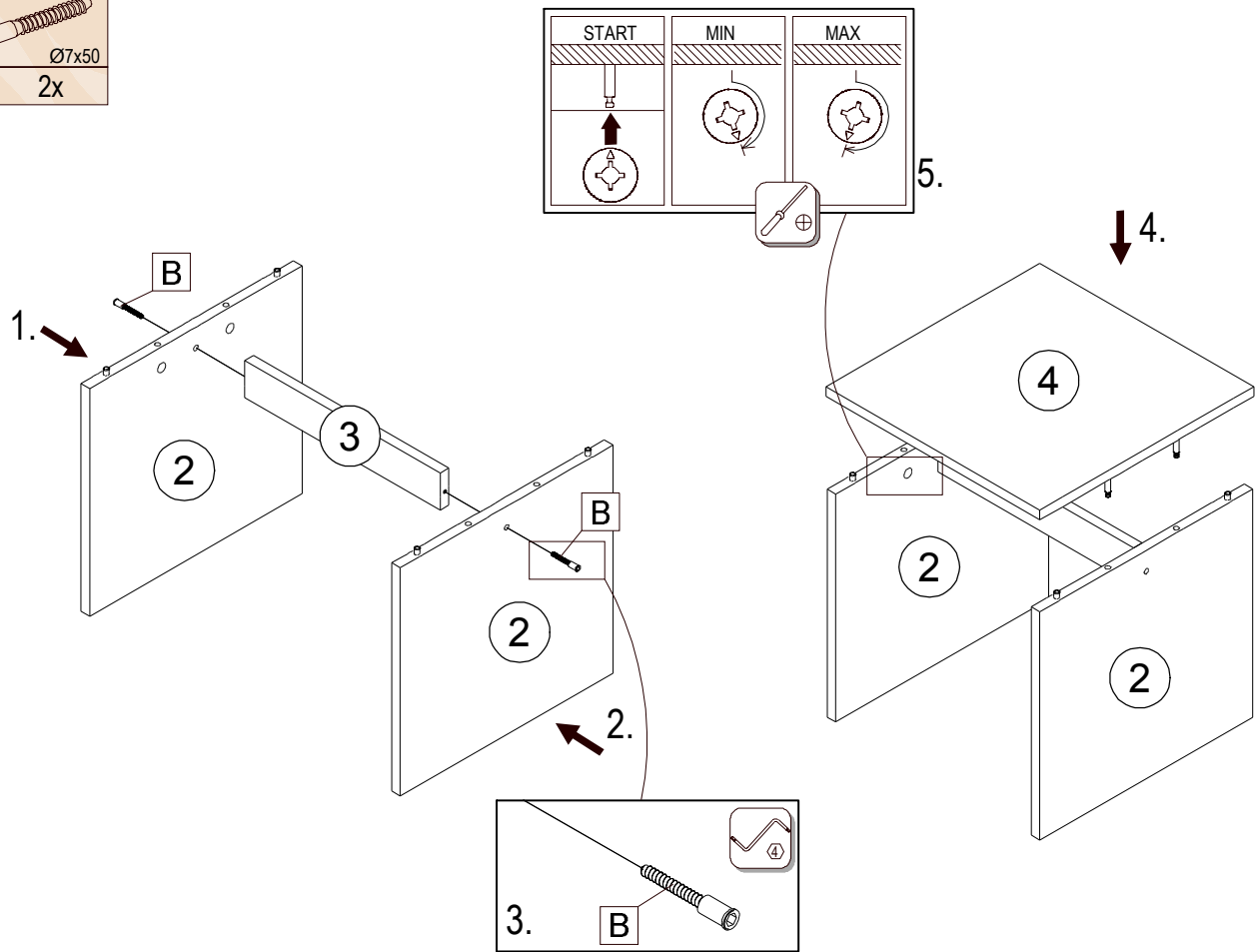
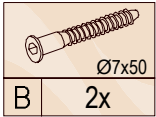
| | | | |
|---|---|---|---|
|  |  |  |  |
| A 12x | C 12x | D 12x | E 12x |



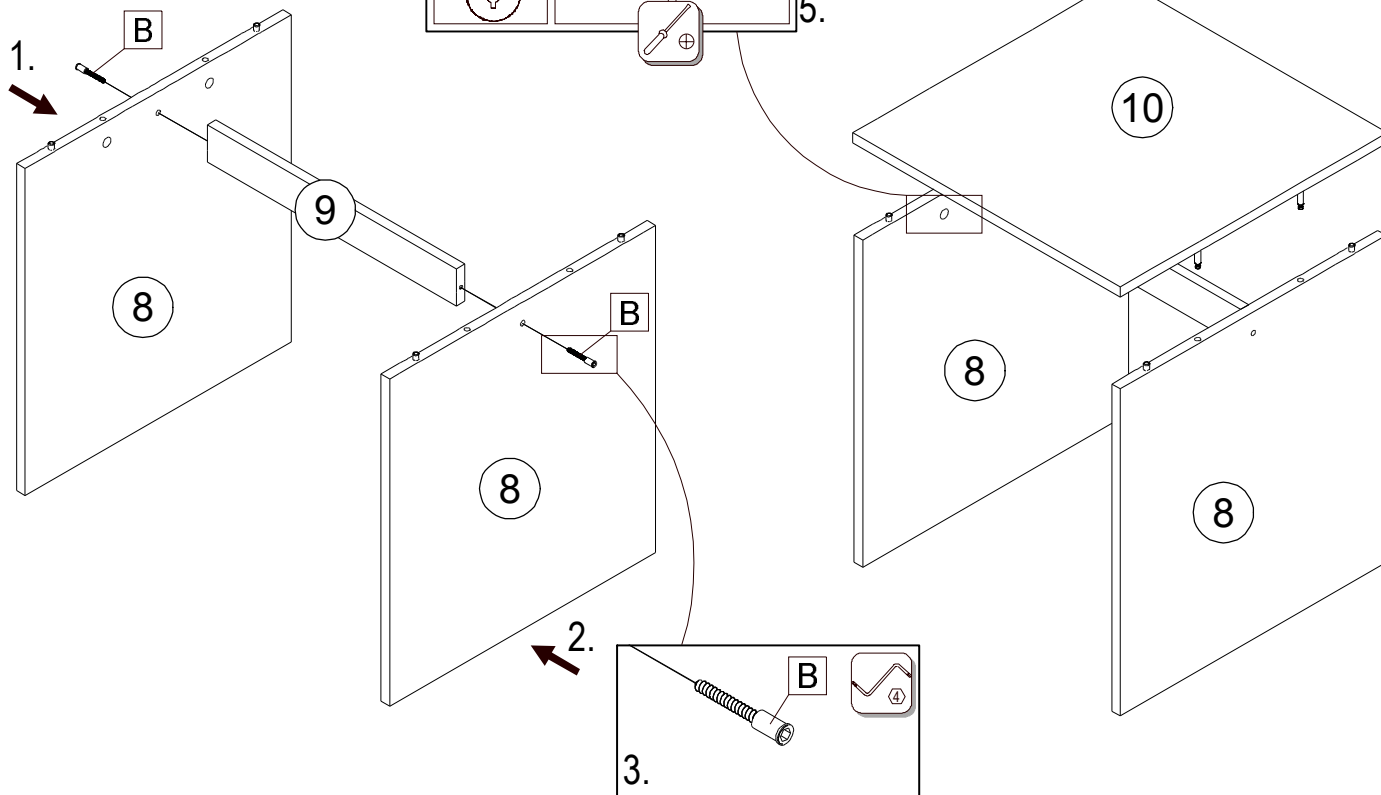
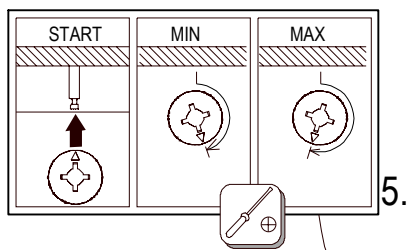

| |
|--|
|  |
| Ø7x50 |
| B 2x |



| | |
|--|---|
|  |  |
| F 12x | G 6x |

