

SK NÁVOD NA MONTÁŽ  
 CZ MONTÁŽNÍ NÁVOD  
 HU SZERELÉSI UTASÍTÁS  
 DE MONTAGEANLEITUNG

# LOGAN NEW GP 03

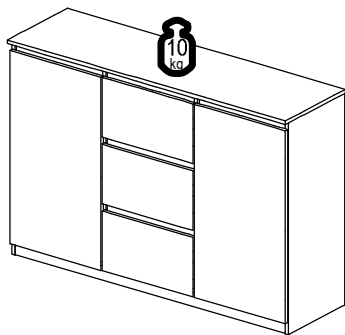

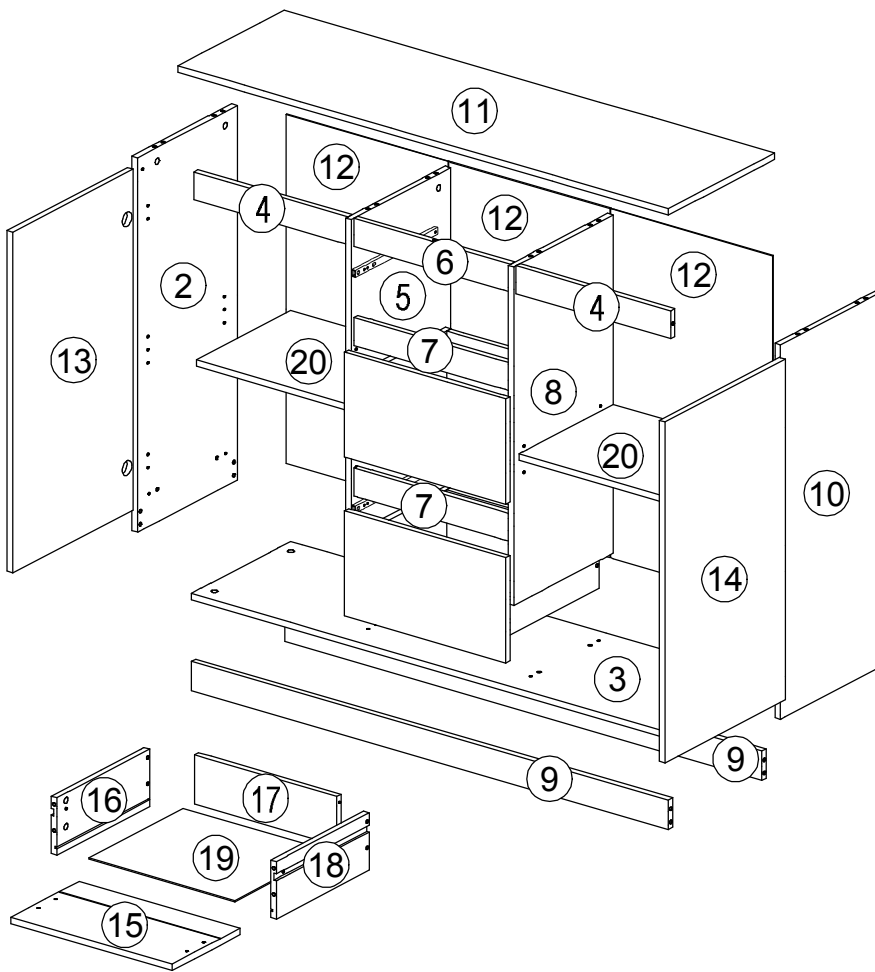

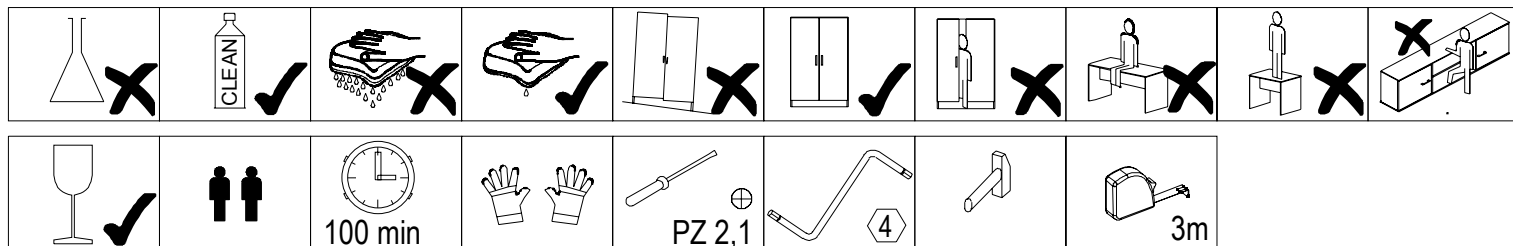

	1376
	931
	400

ID	ID			
12411	2	915*376*16	1x	1/2
12412	3	1338*375*16	1x	1/2
12413	4	433*68*16	2x	2/2
12414	5	827*375*16	1x	2/2
12415	6	440*68*16	1x	2/2
12416	7	440*68*16	2x	2/2
12417	8	827*375*16	1x	2/2
12418	9	1338*72*16	2x	1/2
12419	10	915*376*16	1x	1/2
12420	11	1376*400*16	1x	1/2
12404	12	853*454*2,5	3x	2/2
12421	13	452*833*16	1x	2/2
12426	14	452*833*16	1x	2/2
12423	15	452*257*16	3x	1/2
07837	16	350*140*16	3x	2/2
12424	17	400*120*16	3x	2/2
07838	18	350*140*16	3x	2/2
12425	19	356*410*2,5	3x	1/2
12501	20	433*355*16	2x	1/2



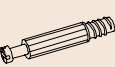



50553,00  A 3x	22244,01  B 8x Ø3,5*16	30090,00  C 6x	27000,00  D 24x Ø8*30	 E 20x	70013,01  F 45x	70021,01  G 41x	22300,00  H 12x Ø7x50	22705,00  J 12x Ø6,3x8	22502,00  K 6x M4x12
22213,00  L 1x Ø4x70	24103,00  M 1x Ø8	31103,00  N 1x	33019,00  P 3x	21102,00  Q 50x Ø1,6x20	22243,00  R 8x Ø3,5x15	35101,01  S 8x	36002,07  T 4x	36002,07  U 4x	8402,03  V 10x
							22236,00  W 10x Ø2,5x16	24008,00  X 10x 3,0	70022,02  Y 2x

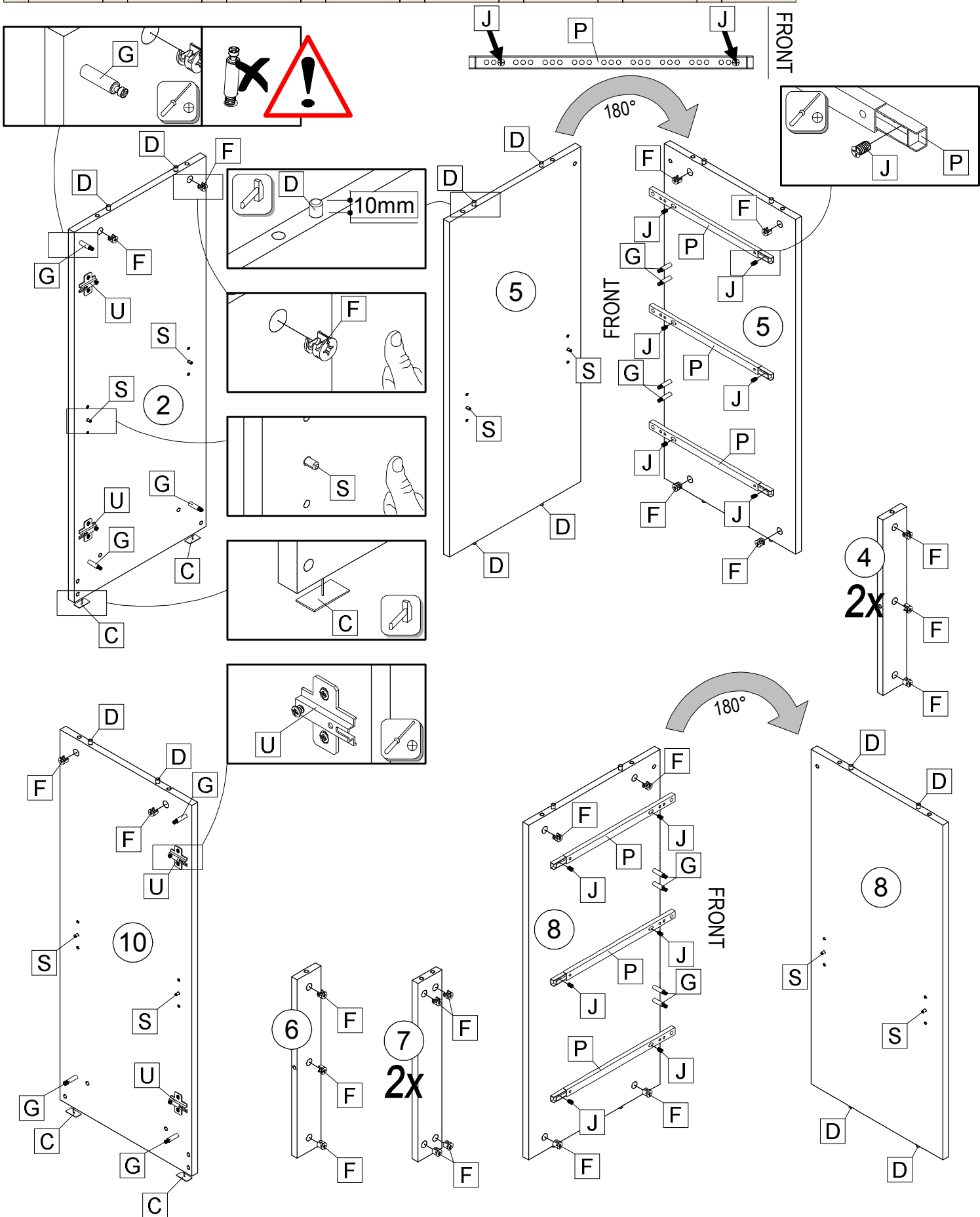

															
C	4x	D	12x	F	29x	G	14x	J	12x	P	3x	S	8x	U	4x

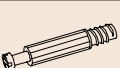
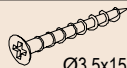

					
C 2x	D 12x	F 4x	G 15x	R 8x	T 4x

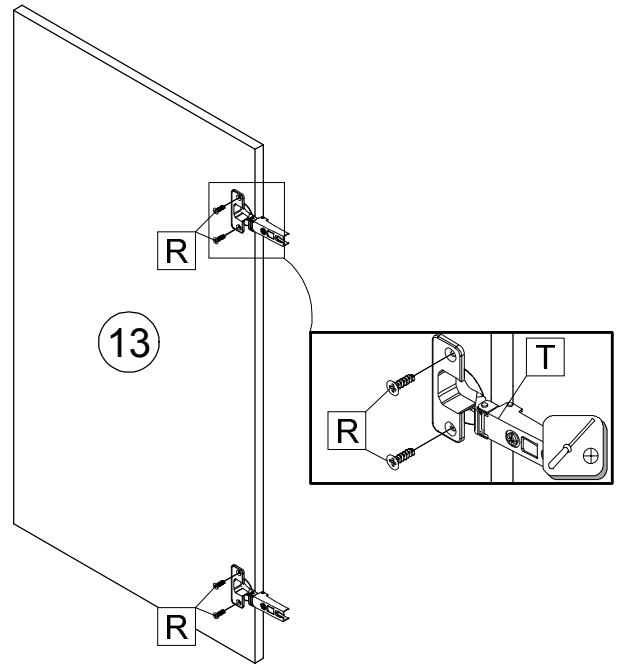
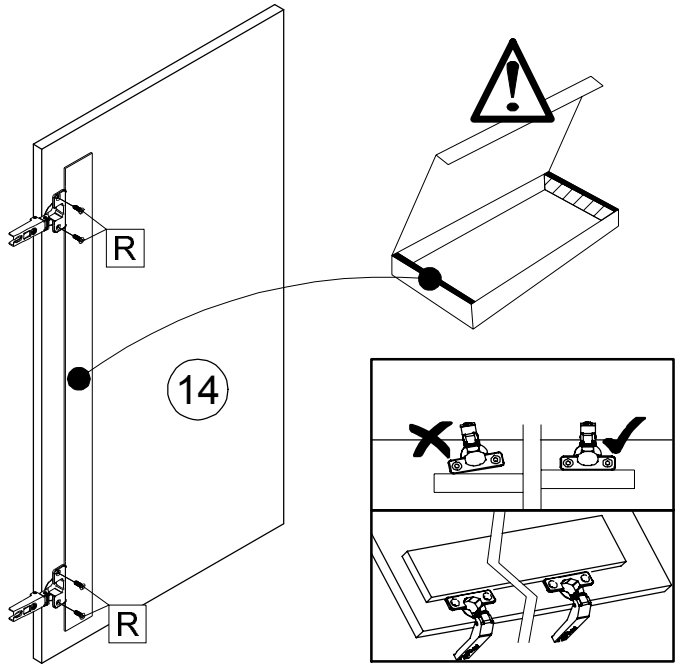
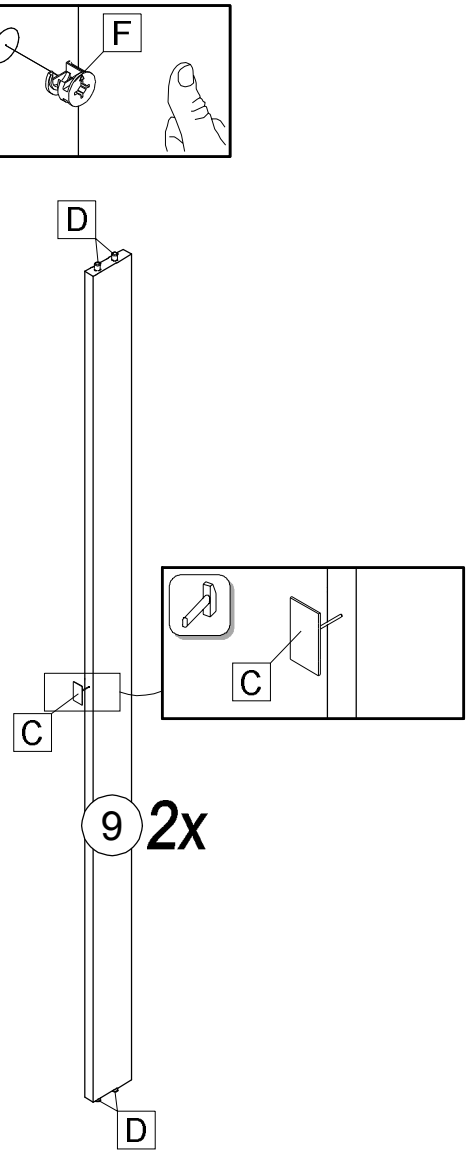
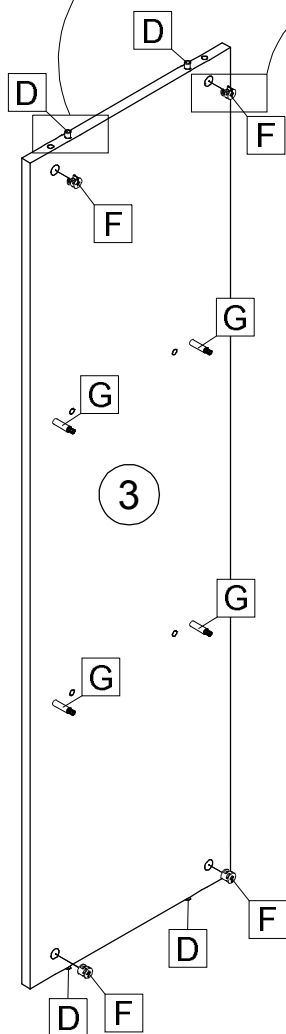
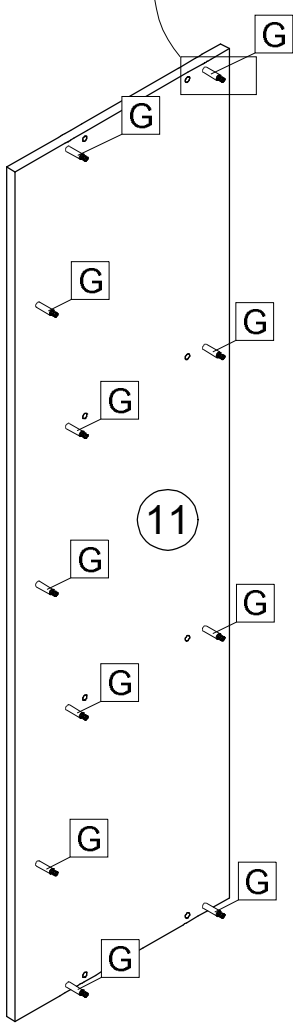
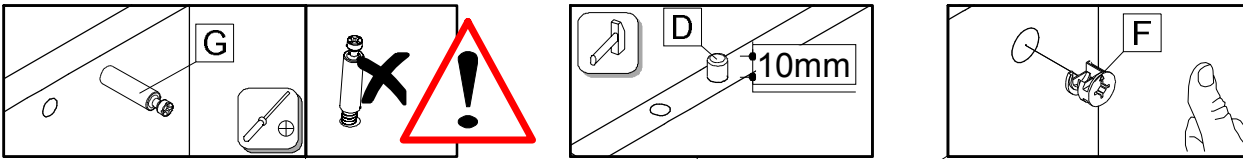

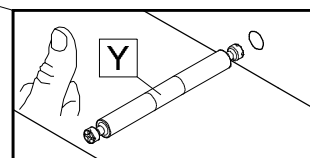
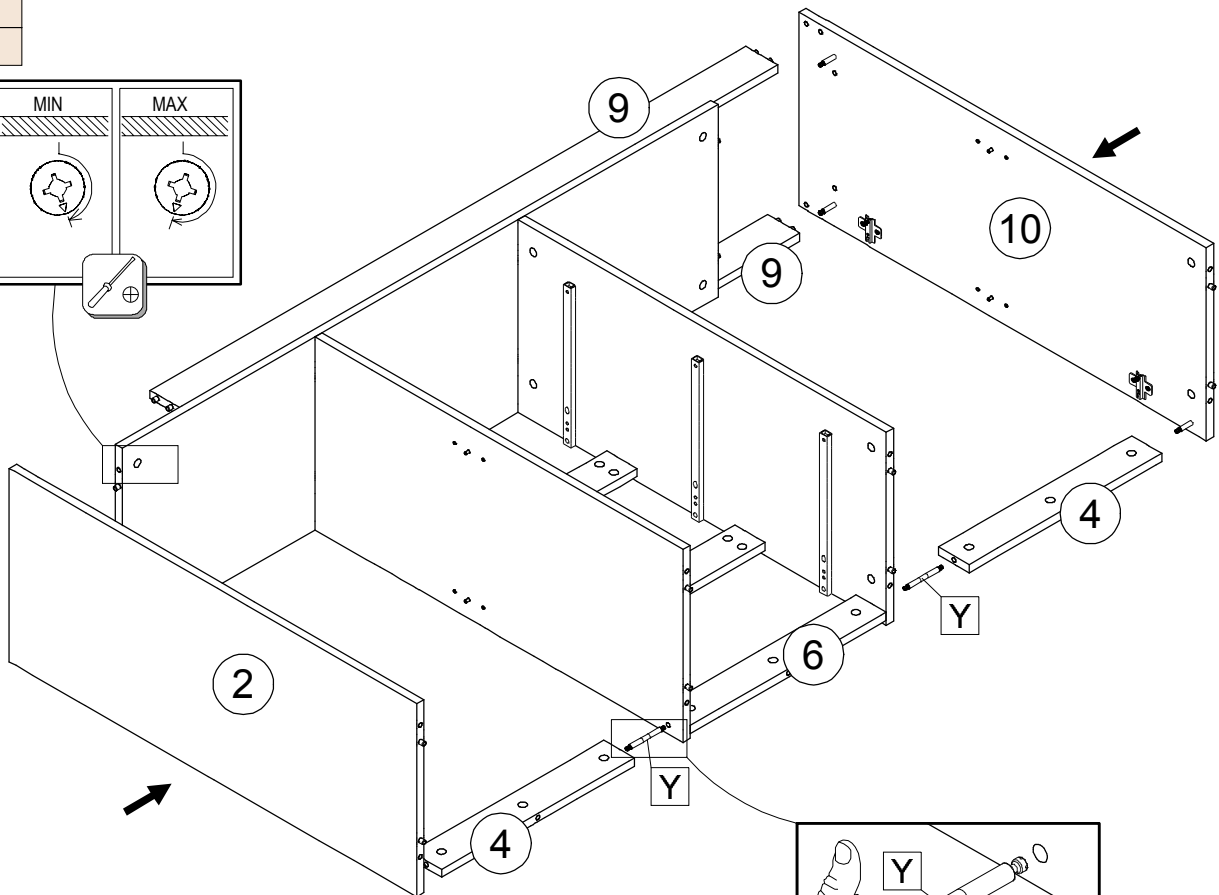
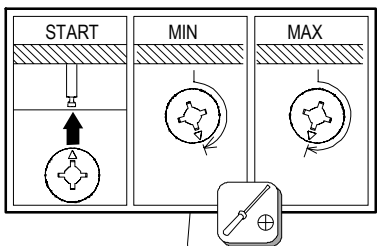
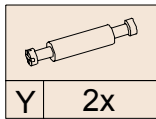
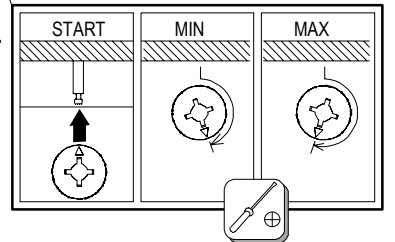
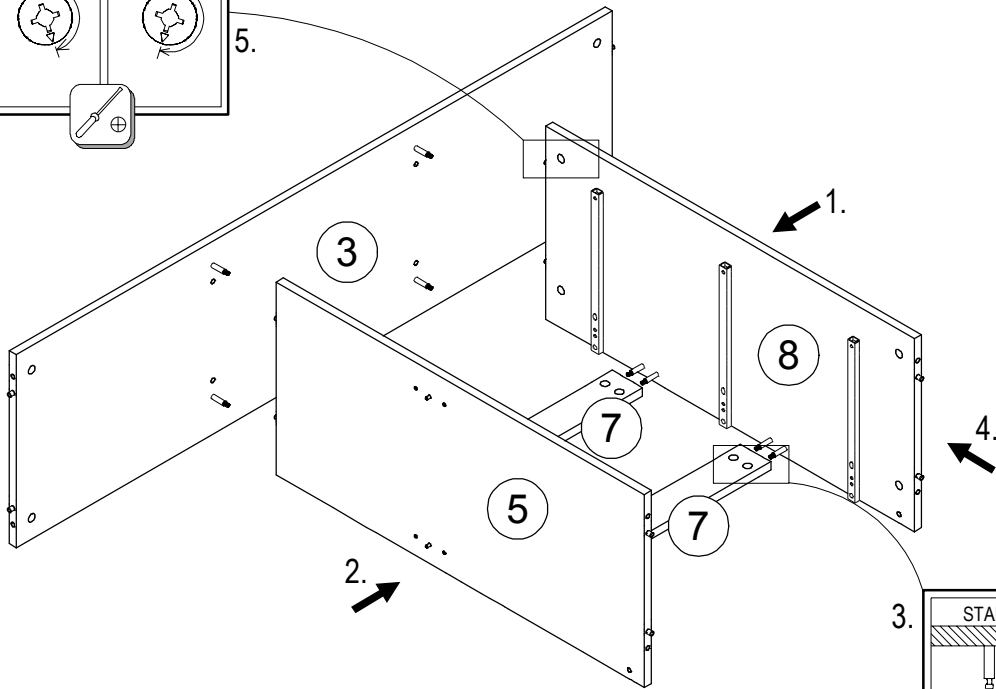
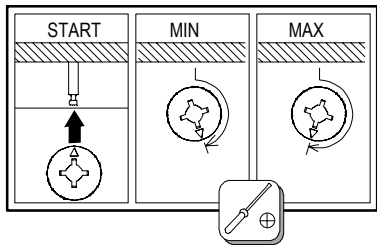

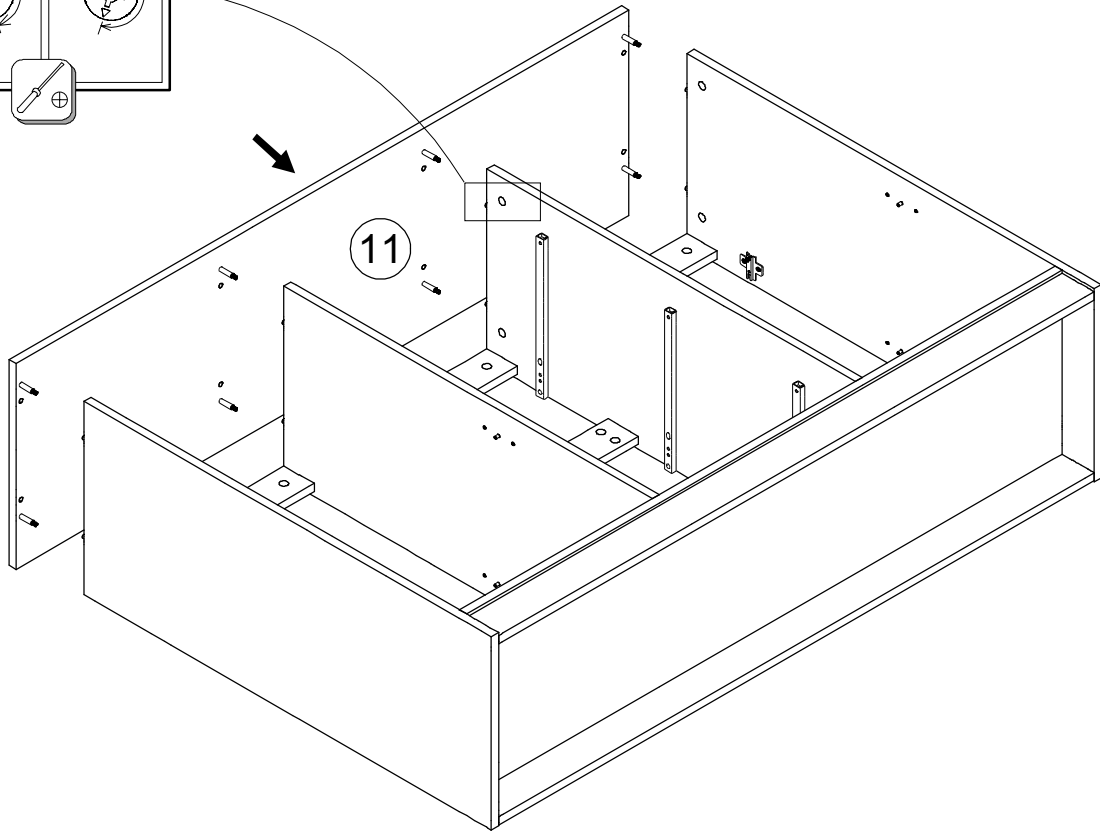
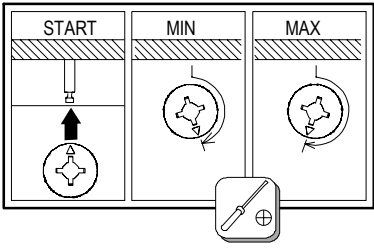



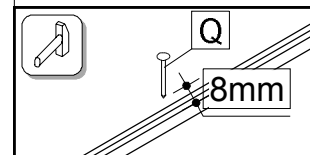
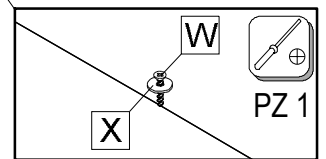
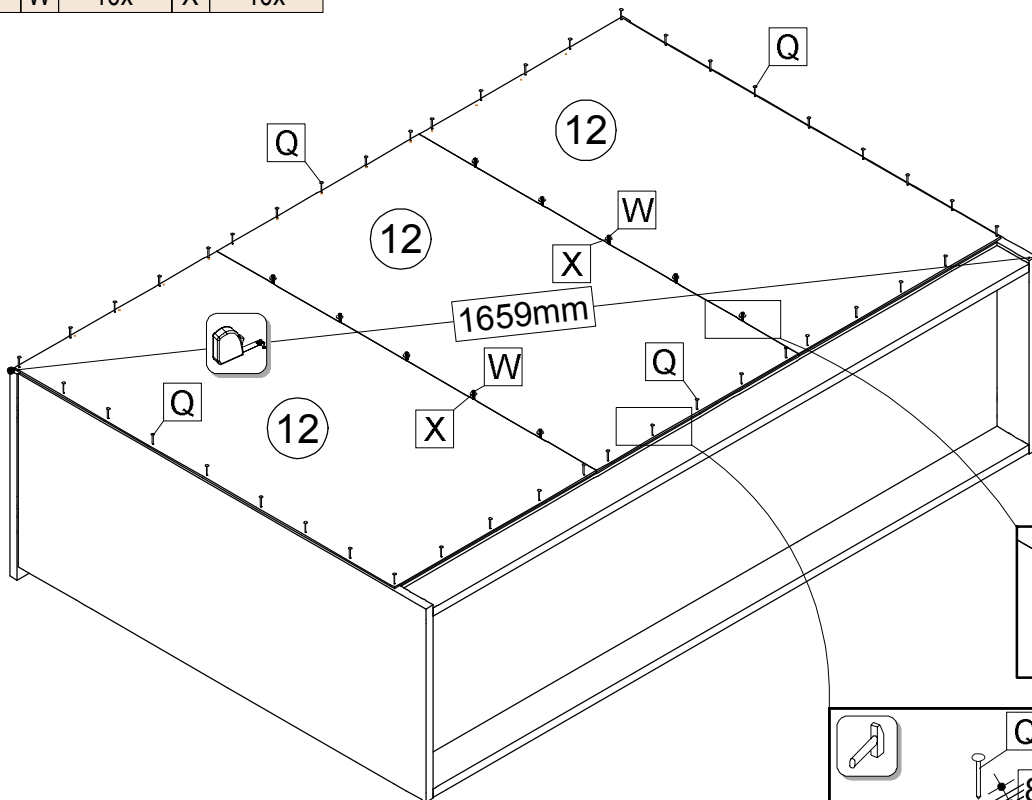

	$\varnothing 1,6 \times 20$		$\varnothing 2,5 \times 16$		3,0
Q	50x	W	10x	X	10x

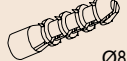

			
Ø3,5*16	Ø4x70	Ø8	
B 2x	L 1x	M 1x	N 1x

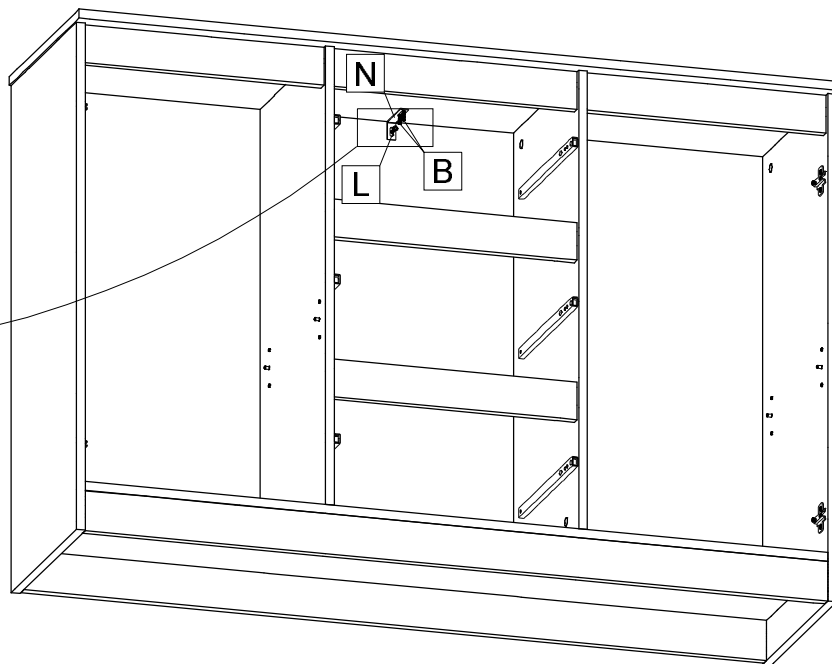
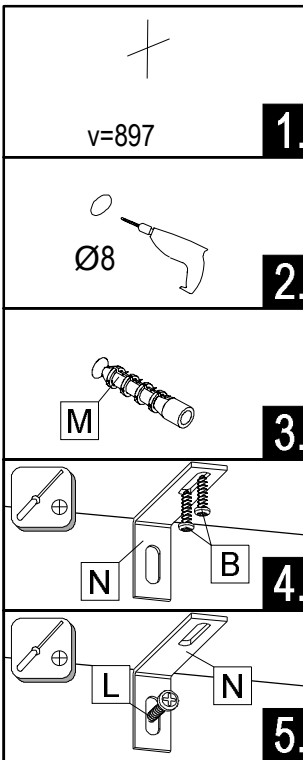
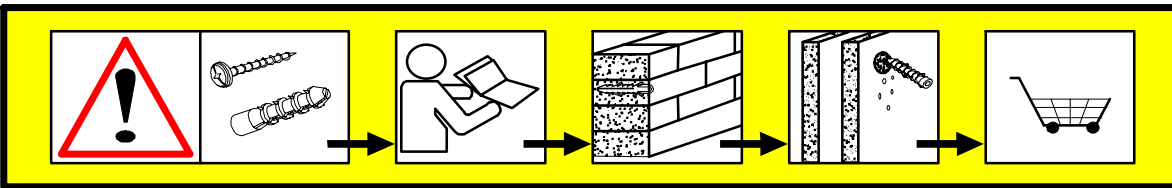

DE

Achtung! Die Wandbeschaffenheit ist vor der Montage unbedingt zu prüfen. Die beigelegten Universaldübel sind ausschließlich nur zur Verwendung für festes Mauerwerk wie Beton/Ziegel. Die Mauerdübel dürfen nicht bei Mauerwerk wie Hohlraumziegel, Leichtbausteinen, Gipskartonplatte oder anderer Rahmenbauweise verwendet werden. Bei diesen Mauerwerken sind gegebenenfalls Spezialdübel zu verwenden! Diese sind in einem Fachgeschäft (Baumarkt) erhältlich. Bei Nichteinhaltung wird seitens Produzenten/Händler und Importeur keine Haftung übernommen.

HU





Vigyázat! Szerelés előtt a falfelületet feltétlenül vizsgálja meg. A mellékelt univerzális tipli kizárólag stabil falazathoz használható mint például beton/tégla. A fali tipli nem használható könnyű építőkövekhez, üreg tégla, gipszkarton lapokhoz vagy más favázás építményekhez. Ezekhez a falfelületekhez csak speciális tiplik használhatóak, melyek szaküzletekben (barkácsáruházakban) beszerezhetőek. Fentiek figyelmen kívül hagyása esetén a gyártó/kereskedő vagy forgalmazó nem vállal felelősséget.

SK

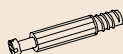

Upozornenie! Pevnosť steny sa musí pred montážou bezpodmienečne skontrolovať. Univerzálne hmoždenky, ktoré sú obsiahnuté v balení, používajte jedine pre pevné murivo ako je betón/tehla. Hmoždenky sa nesmú používať v prípade ľahkého staveného muriva, dutina tehla, u sádrokartónových dosiek alebo iných konštrukcií rámu. U týchto murív je nutné použiť špeciálne hmoždenky! Tieto je možné dostať v špeciálnych predajniach so stavebným materiálom (stavebniny). Pri nedodržaní pokynov nepreberajú výrobcovia/predajci a dodávatelia zodpovednosť za vzniknuté škody.

CZ

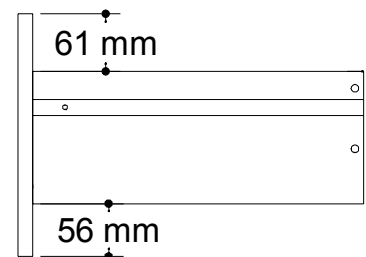
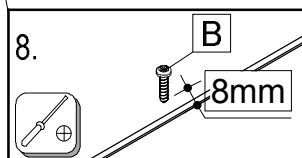
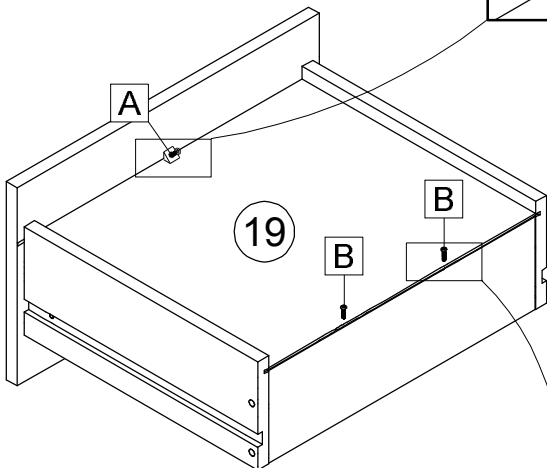
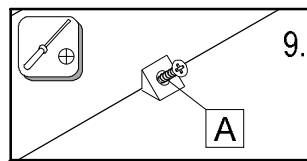
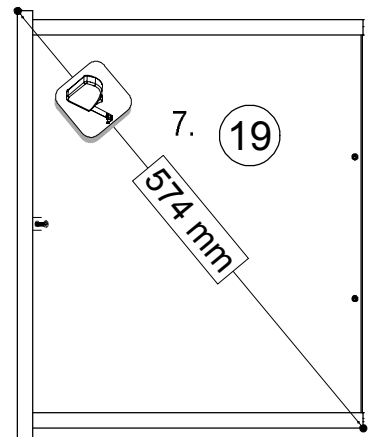
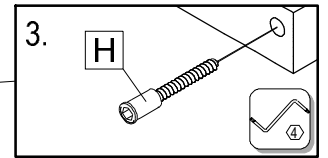
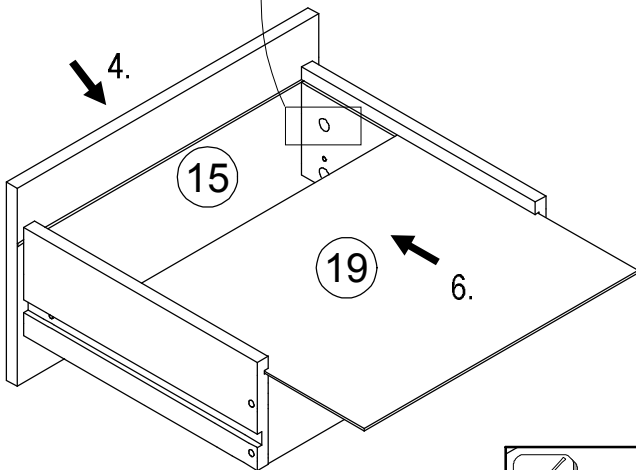
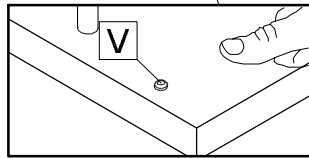
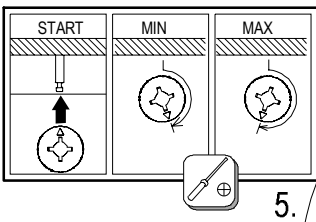
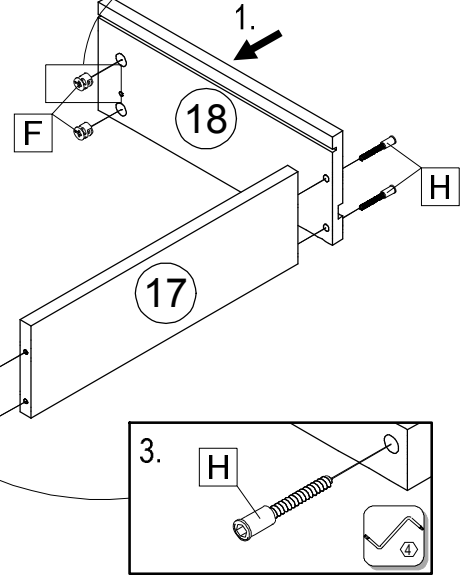
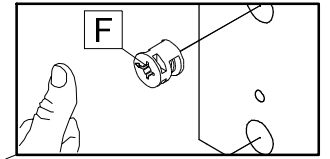
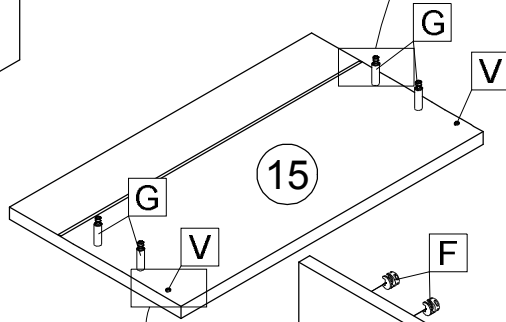
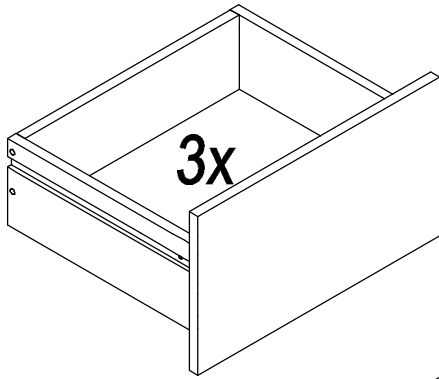
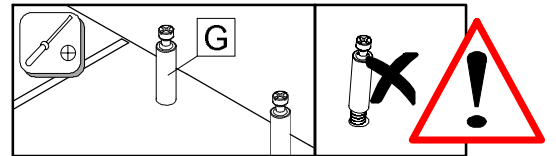

Upozornění! Před montáží je nutné zkontrolovat stav stěny. Příložené univerzální hmoždinky jsou určeny pouze k použití pro pevné zdivo jako beton/cihly. Hmoždinky do zdi se nesmí používat u dutinová cihla, zdiva jako pórovitý stavební kámen, sádrokartónová deska nebo jiný měkký materiál. U těchto zdív jsou nutné použít speciální hmoždinky! Jsou k dostání v speciálních prodejnách se stavebním materiálem. Při nedodržení těchto pokynů výrobce/prodejce a dovozce neručí za způsobené škody.

					
A 3x	B 6x	F 12x	G 12x	H 12x	V 6x

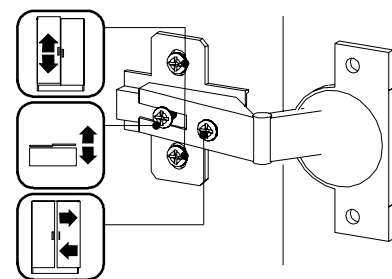
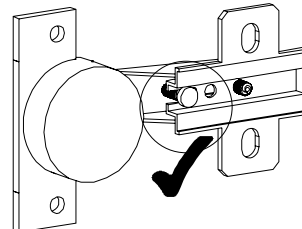
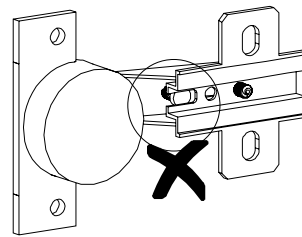
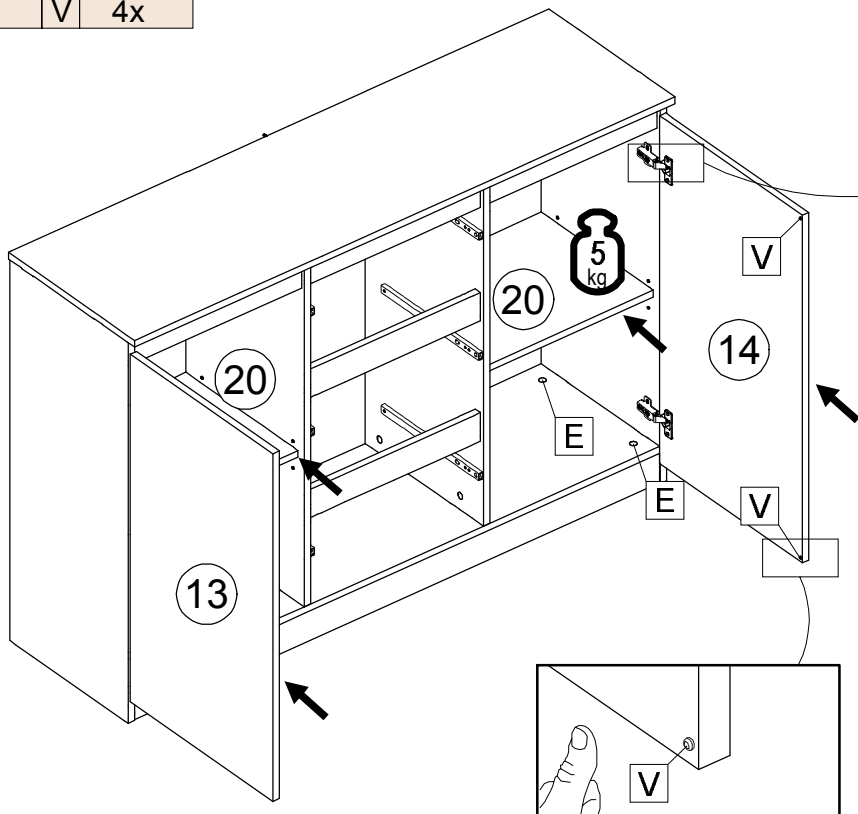

	
E 8x	V 4x



	
E 12x	K M4x12 6x

