

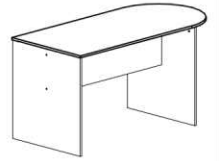

ASSISTANT
AS-022-za
 1500*700*760





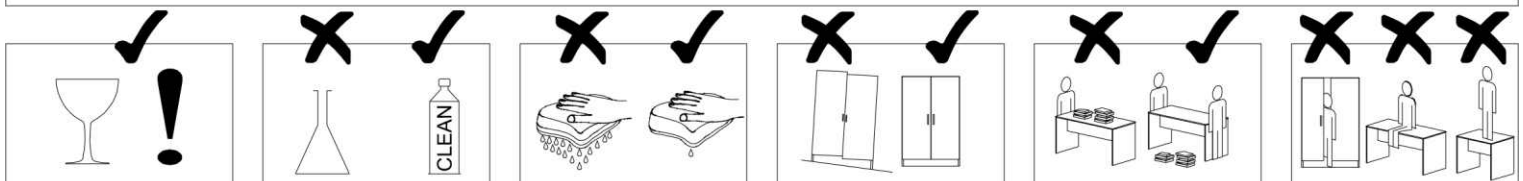
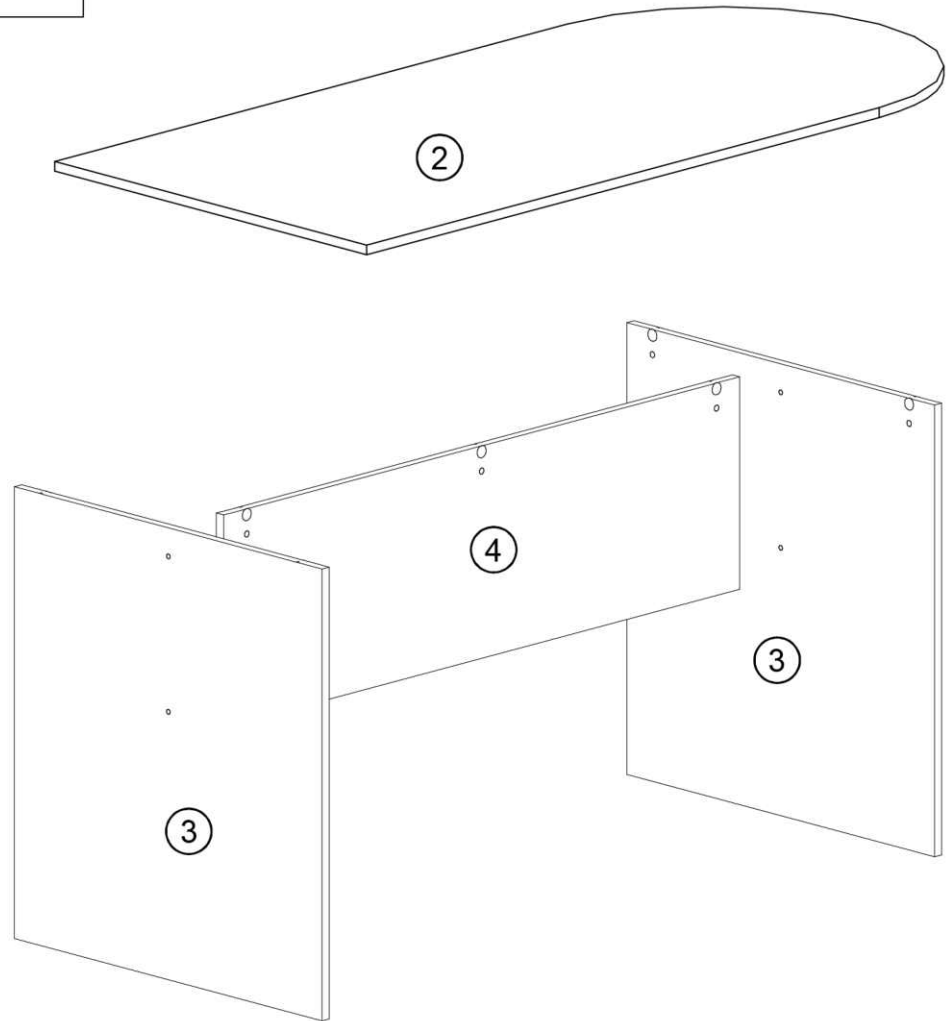

70014,00	70015,00	22300,00		21100,00	30100,07
A	B	C	D	E	F
7x	7x	4x	4x	8x	4x

0h 30min		4		≤ 0,5 kg	

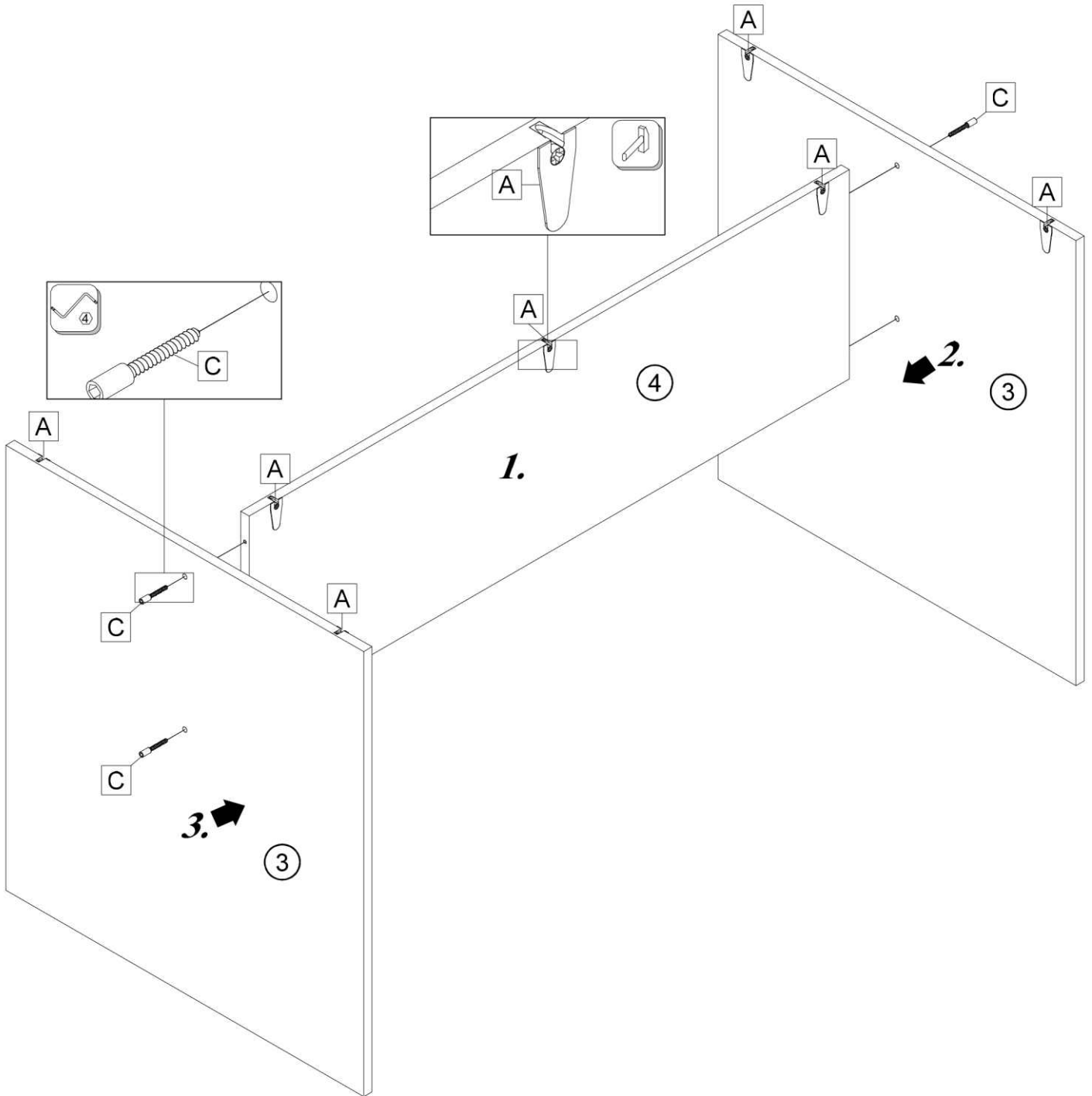
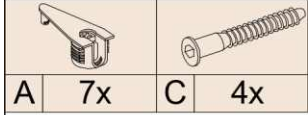
ID	ID			
00131	②	1500*700*16	1x	1/1
00127	③	744*690*16	2x	1/1
00129	④	1158*350*16	1x	1/1





			
B 7x	D 4x	E 8x Ø1,6x20	F 4x

