

INFINITY I-11

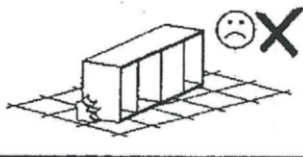

Narzędzia potrzebne do montażu

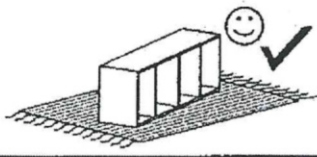
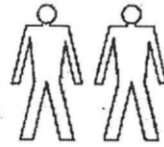
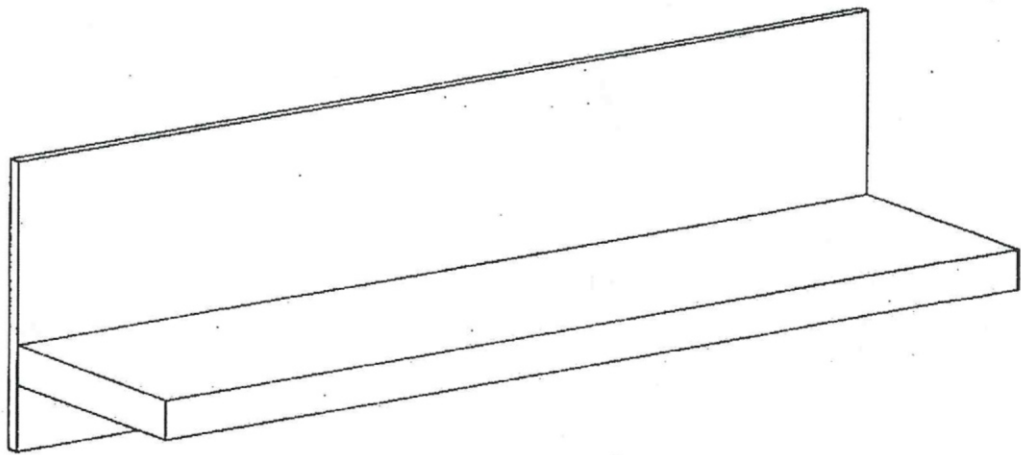
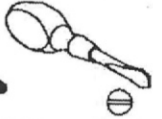
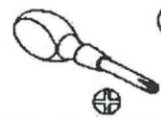
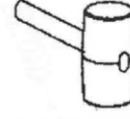
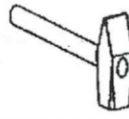

E - 3x

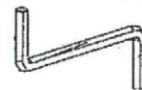

Z - 1x

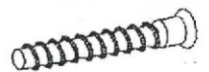

W - 4x

①

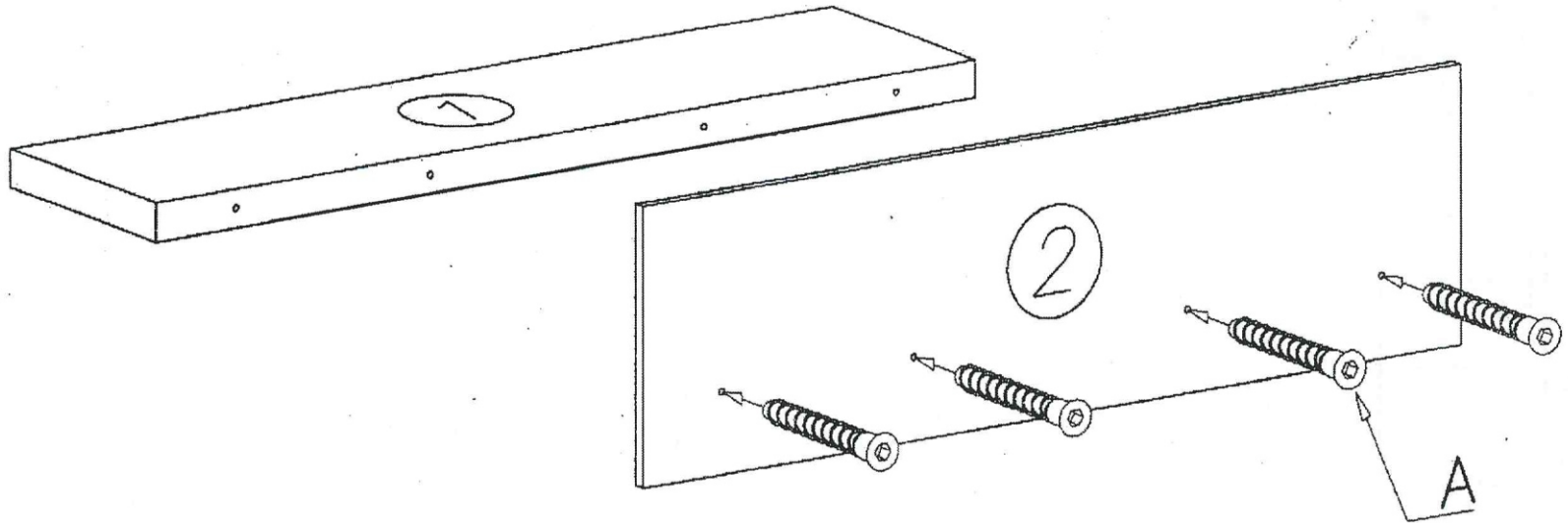

②

