

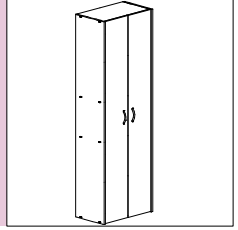

ASISTENT
 AS-007-00
 572*336*1751

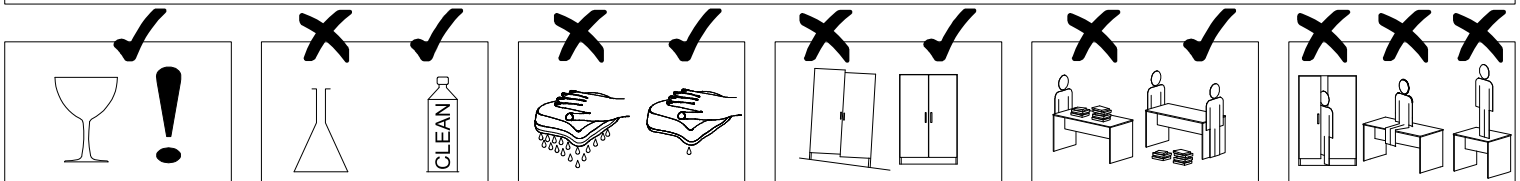

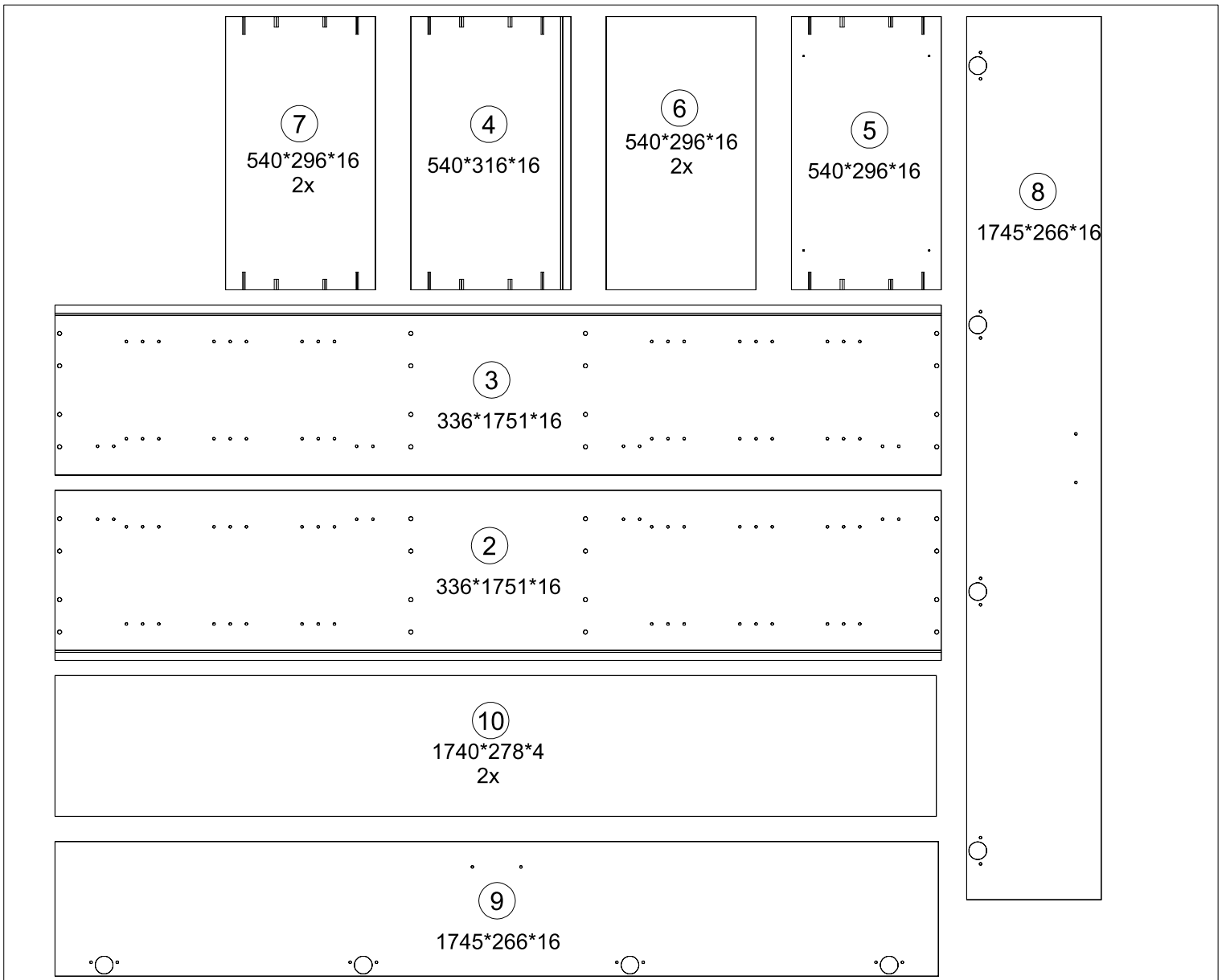

A 16x	B 24x	C 16x	D 16x	E 8x	F 8x	G 8x	H 2x	J 12x	
0h650min		4	5,56x6125	≤60,56kg	0,6m	3m			

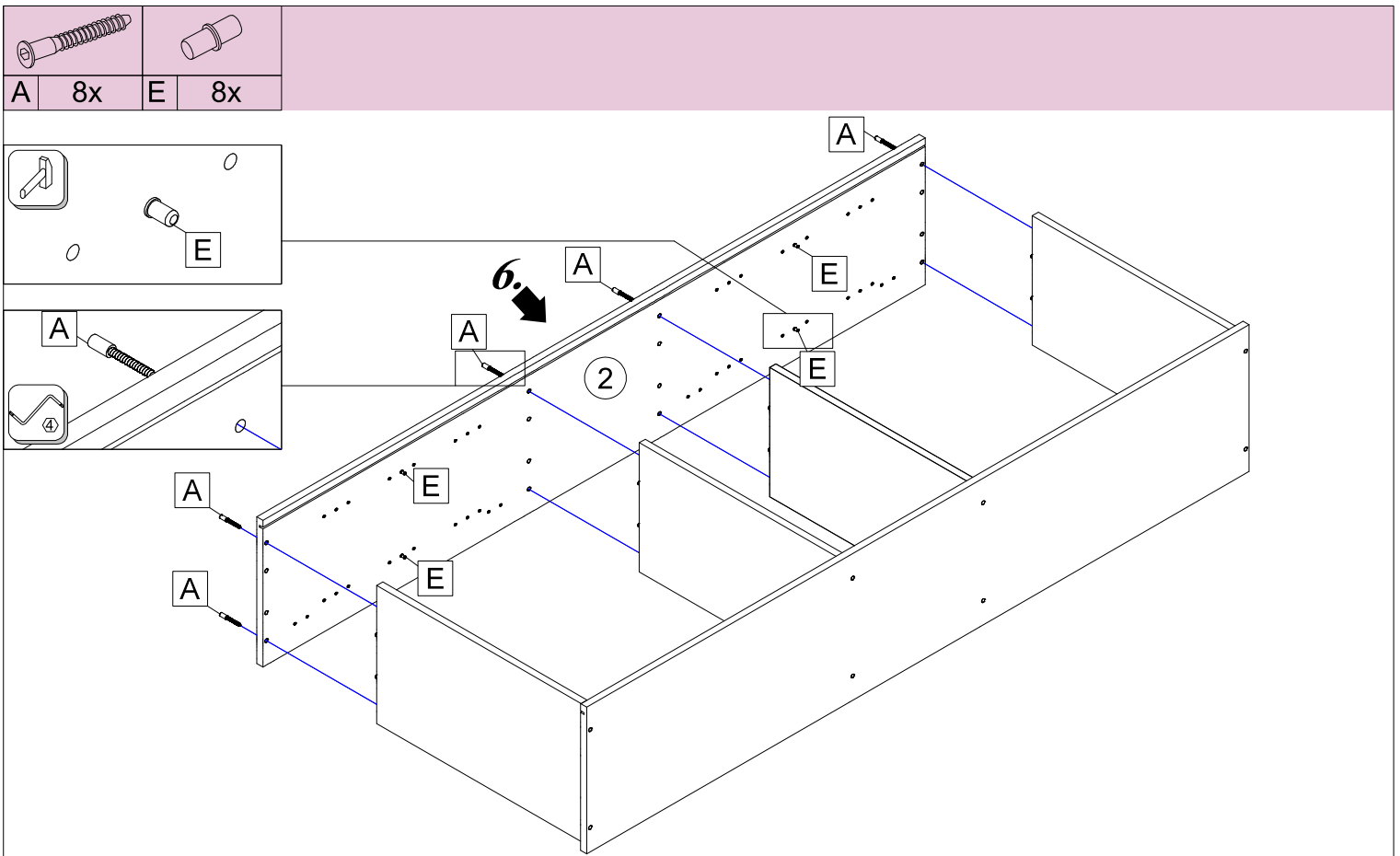
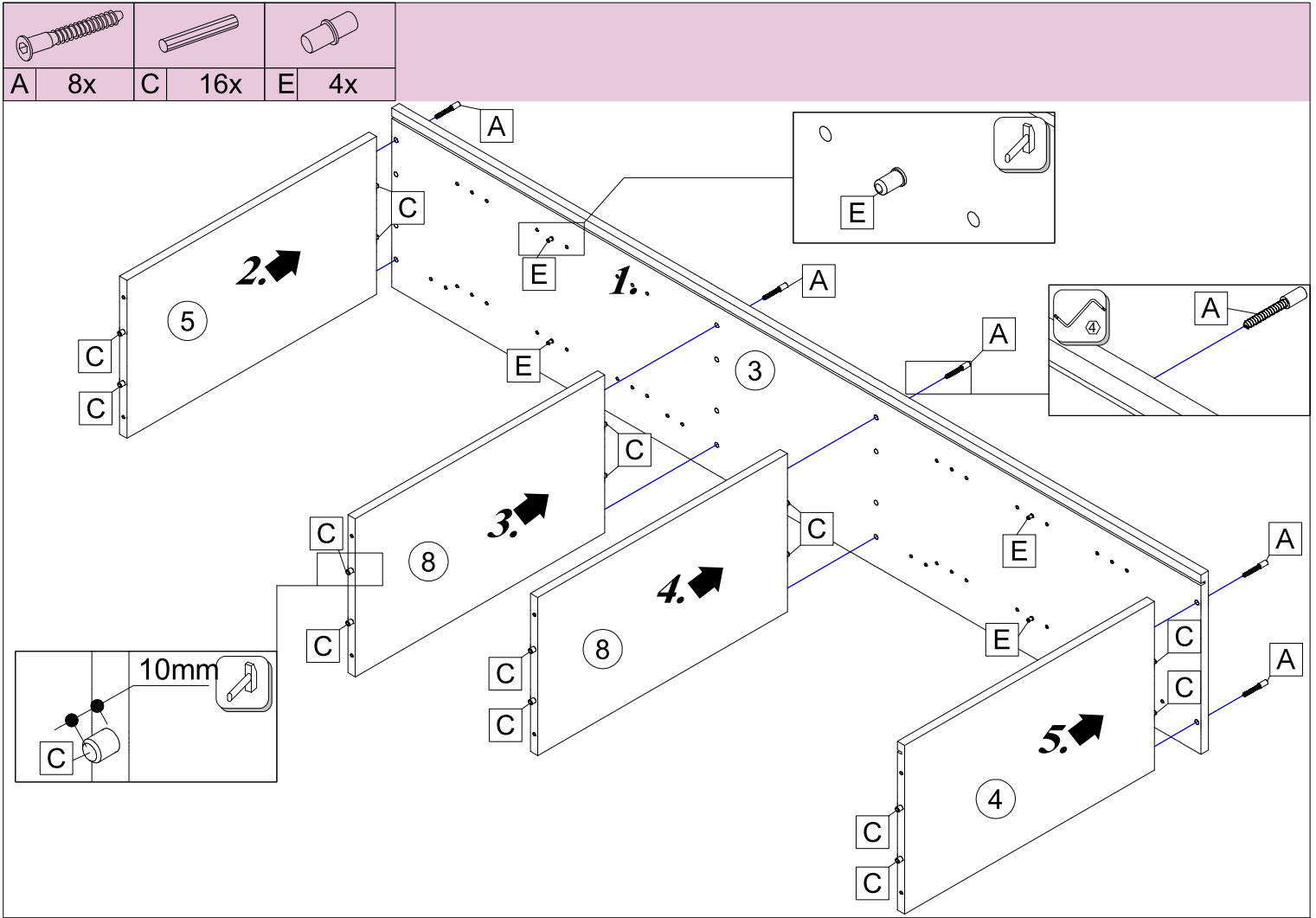

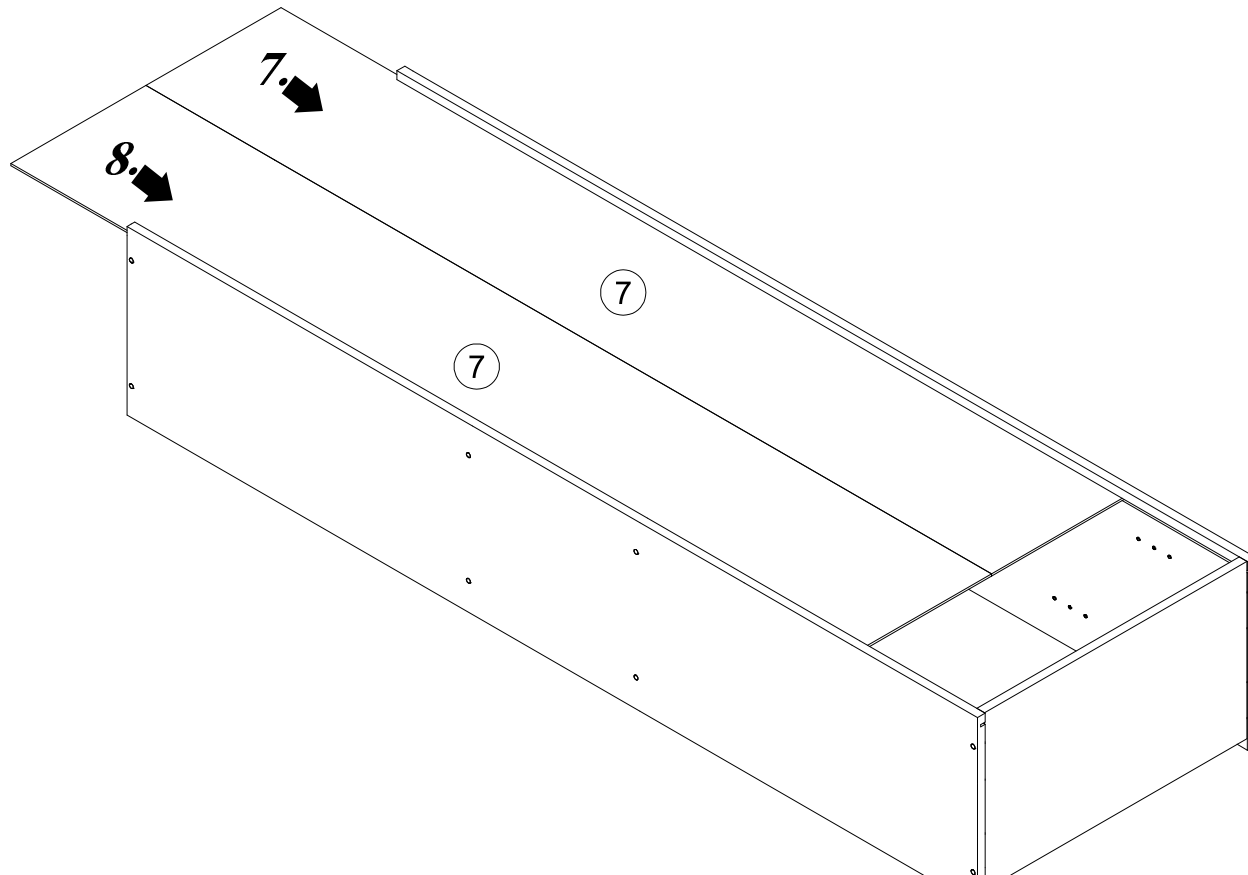





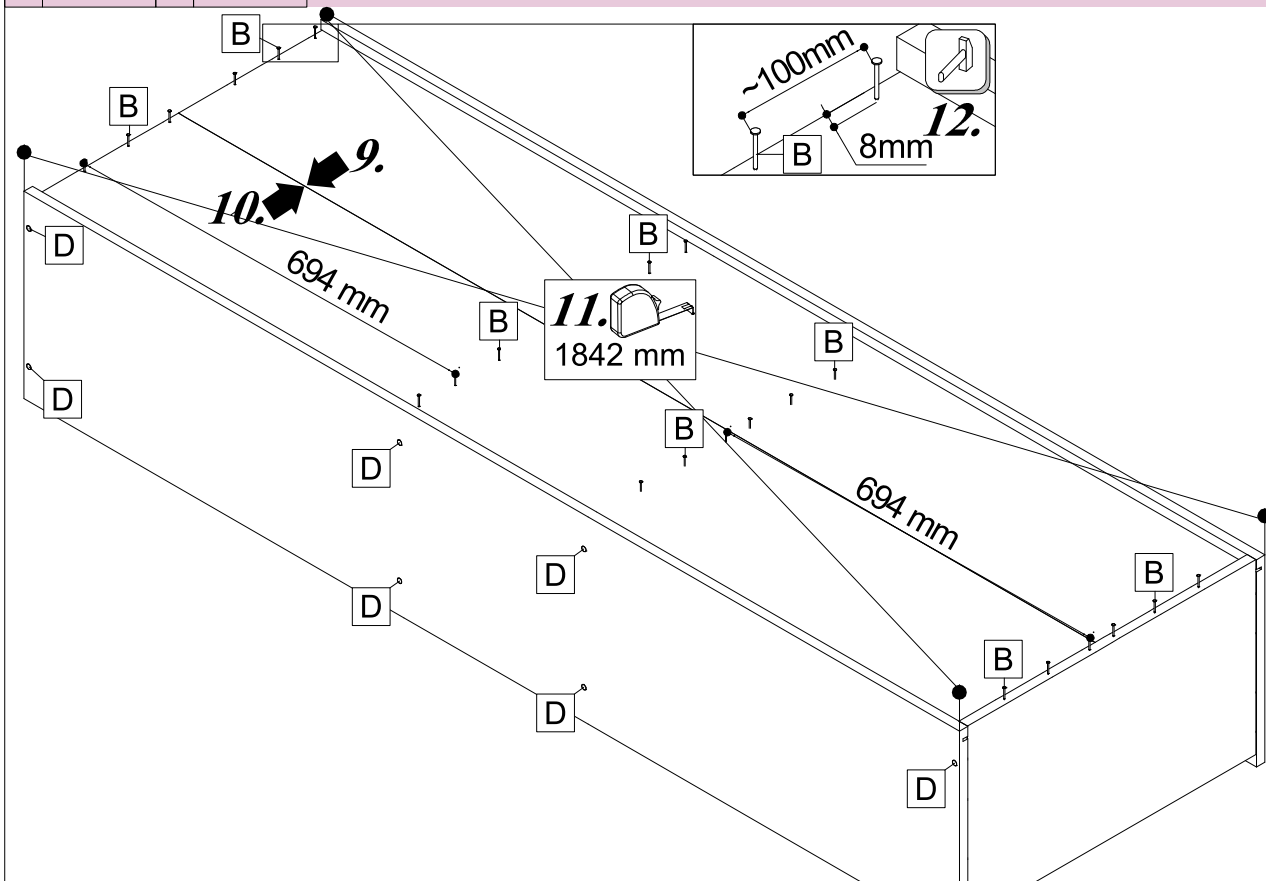

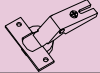
	Ř1,6x20		
B	24x	D	16x



			
F 8x	G 8x	H 2x	J 16x

