

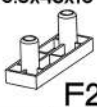





1

6.5x48x16	†8x30mm
	
F2	A
4	12

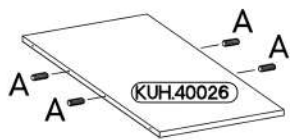
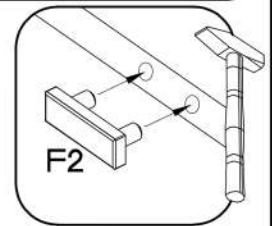
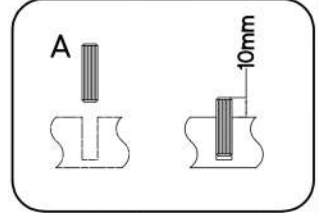
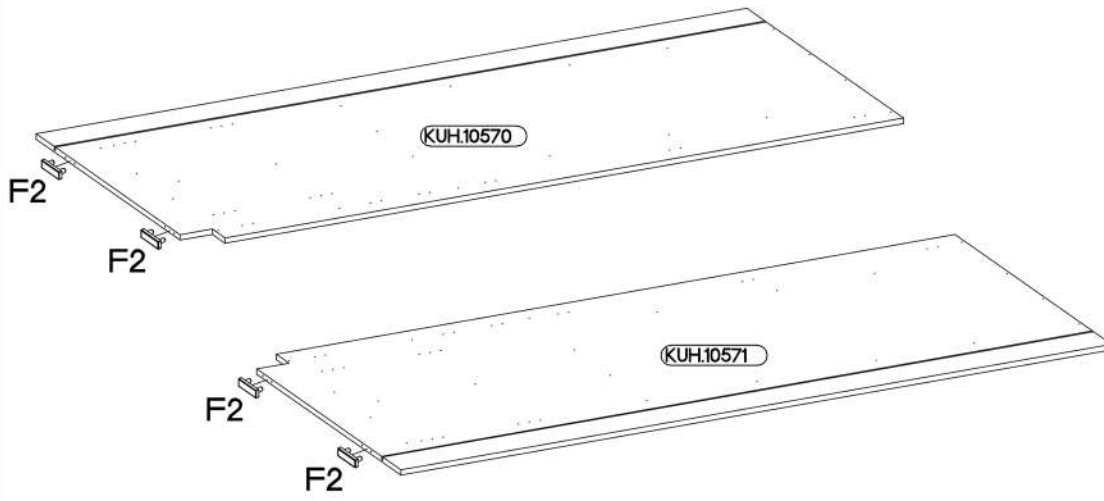

2

6,4 x 50mm			
	B	O	E1
	6	1	6

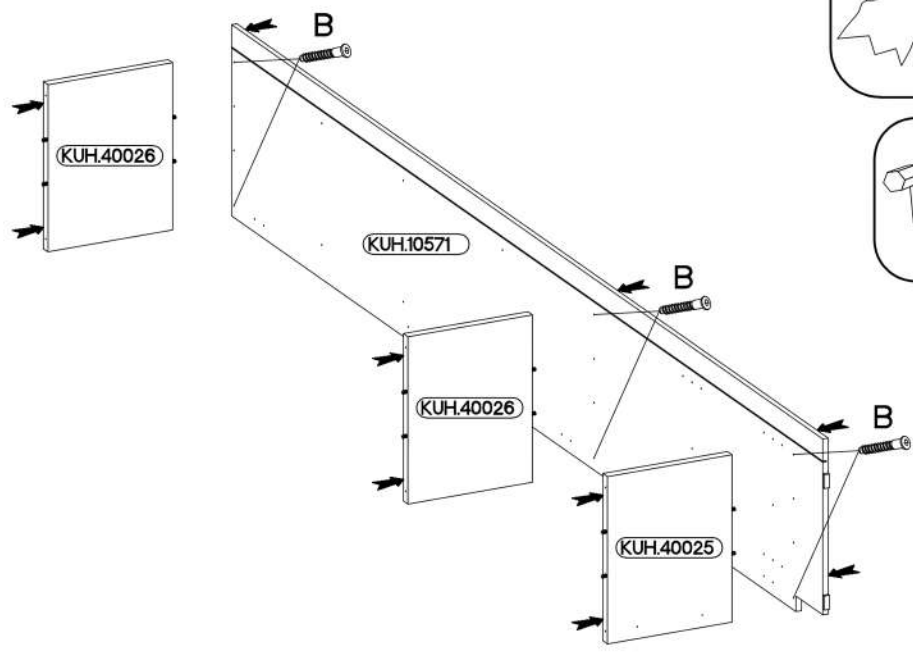
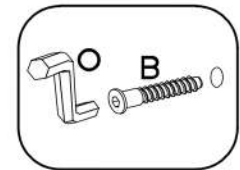
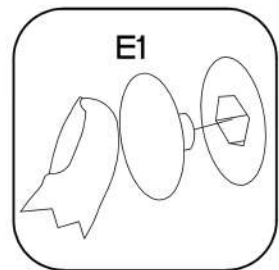

3

6,4 x 50mm

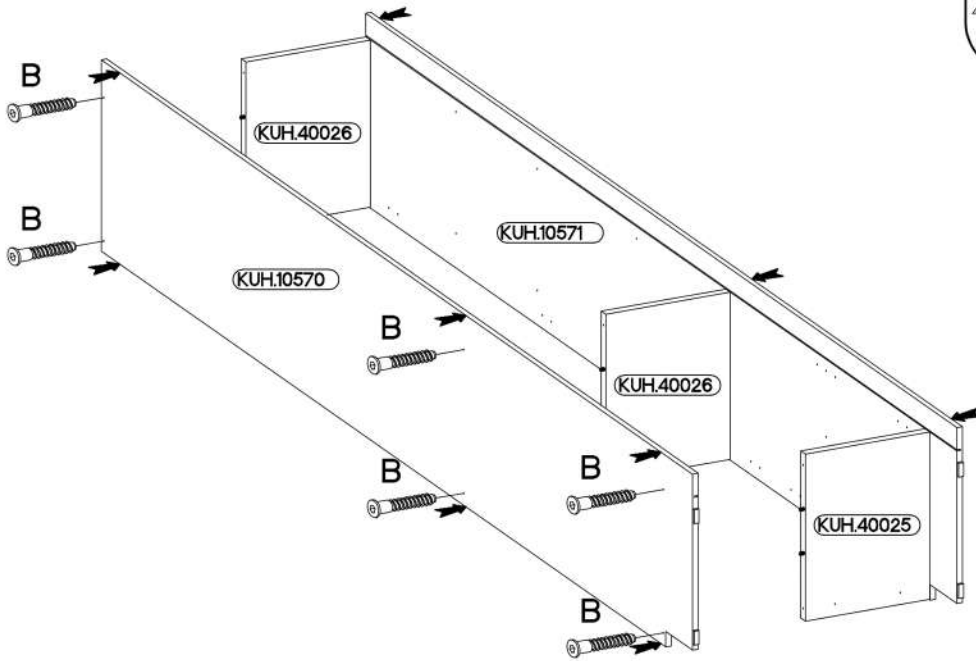
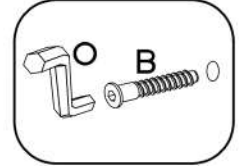
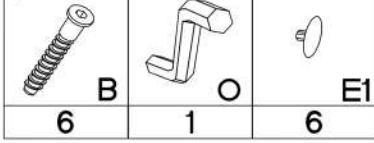

4

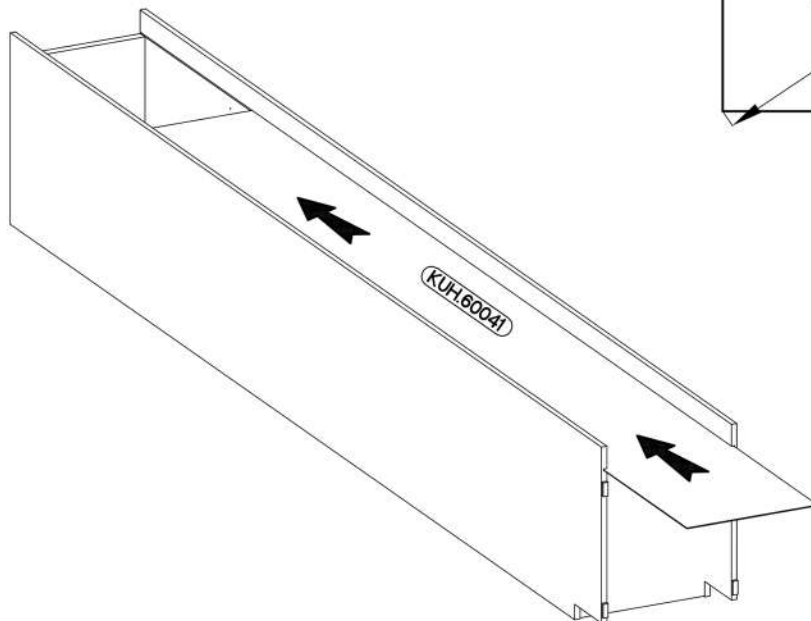
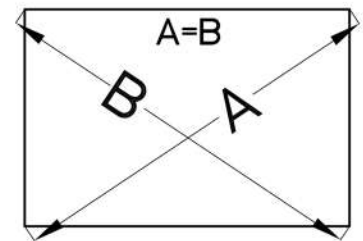

5

±3.0x20mm



P7

10-15

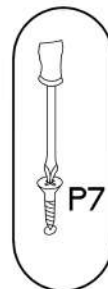

P7

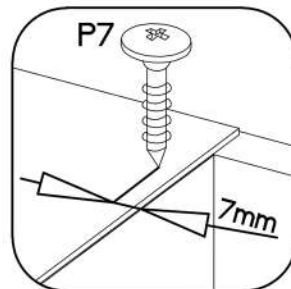

P7

7mm

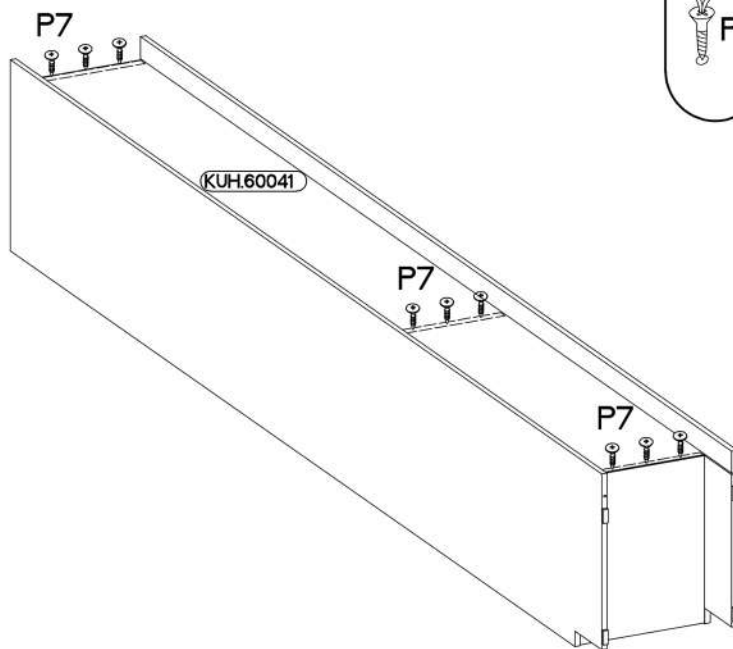

KUH.60041

P7

P7

P7

6

±4.0x45mm



P4

2



E9

2



P4

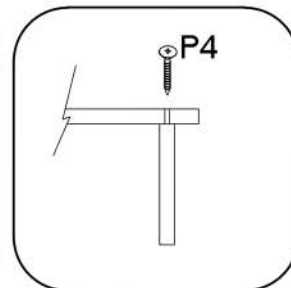

P4

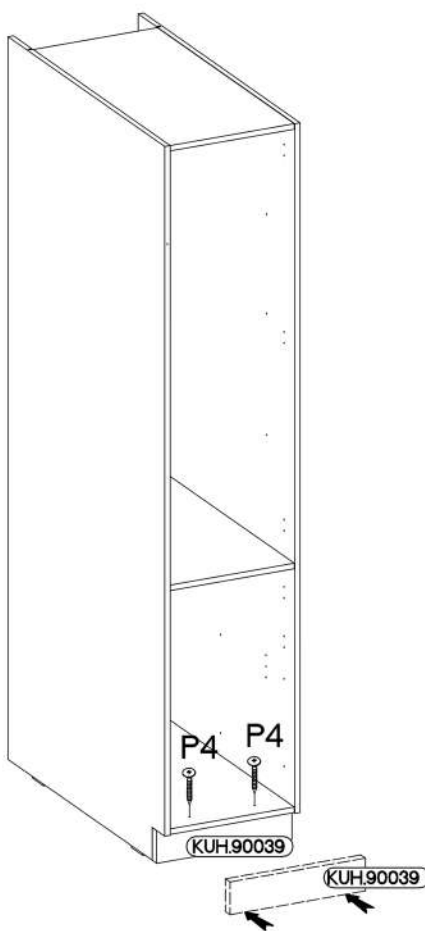

P4

P4

KUH.90039

KUH.90039

7

±5/19mm



J

16

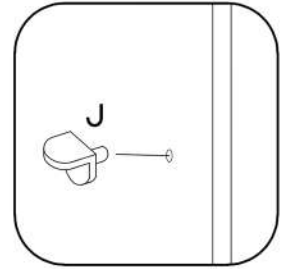
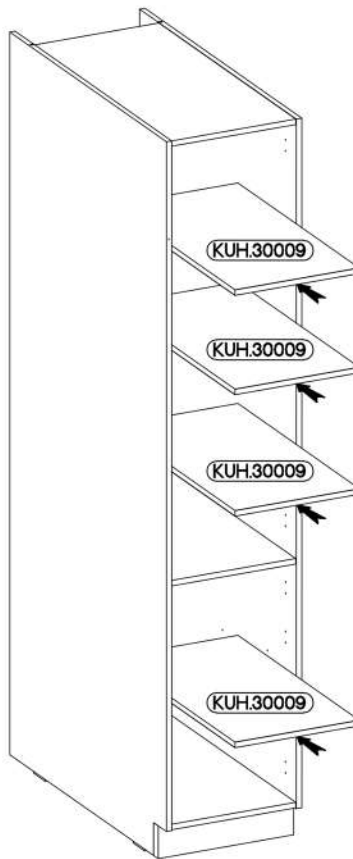

8

120x30x15mm



L25

1

±3.5x13mm



P5

2

1.

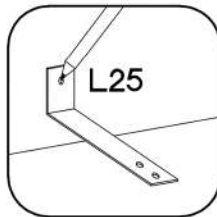

2.

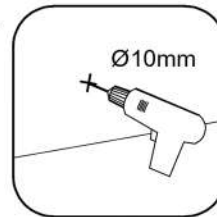

3.

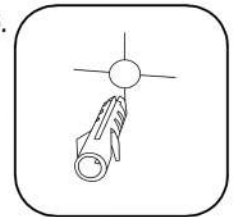

4.

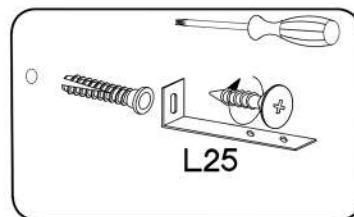

5.

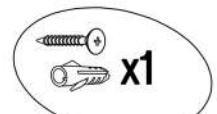
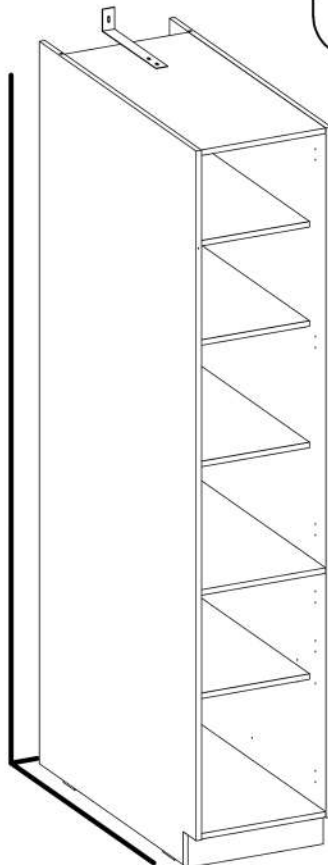
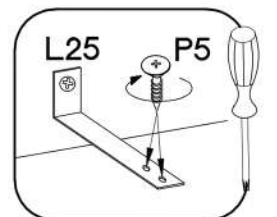

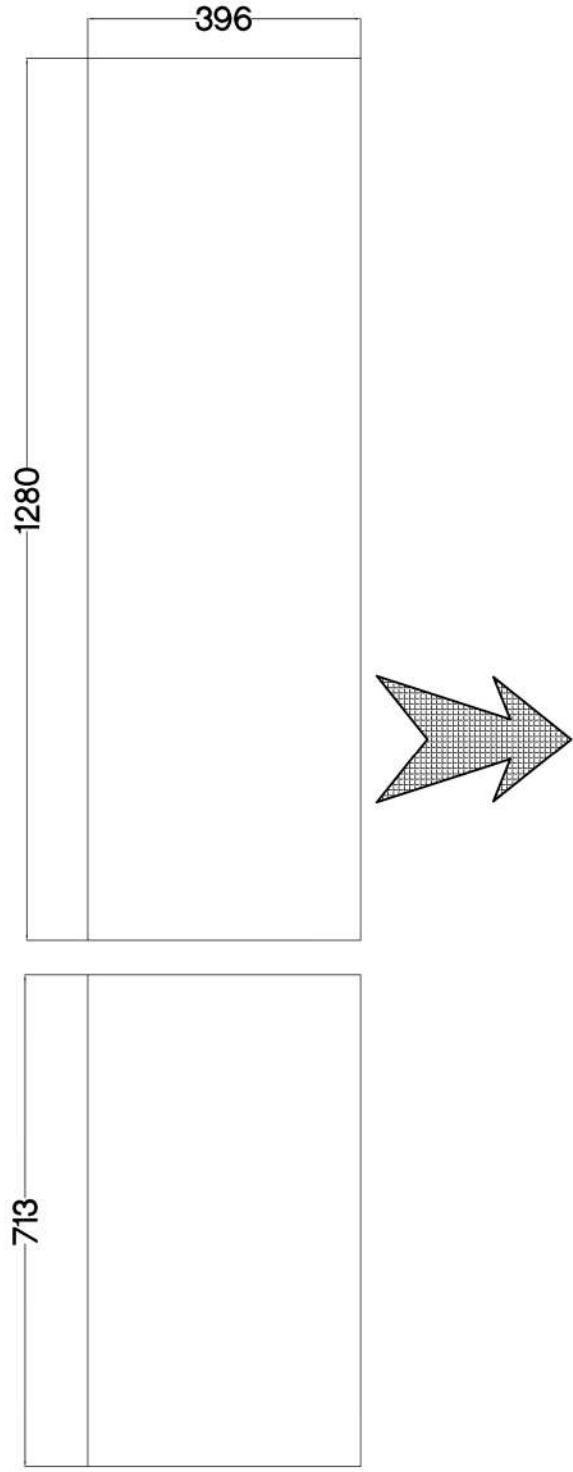

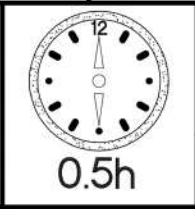
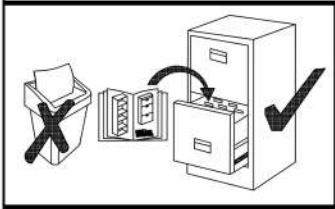
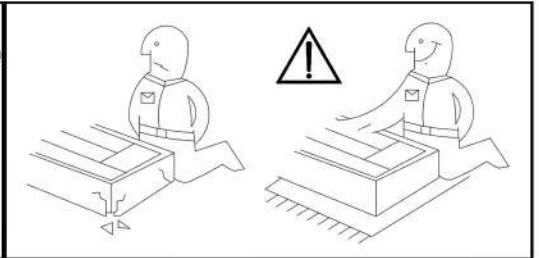
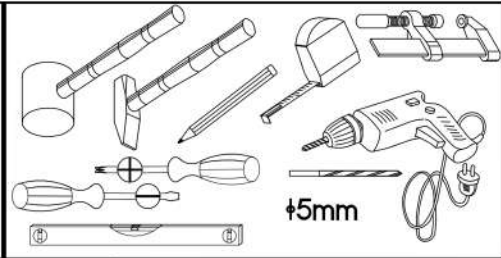
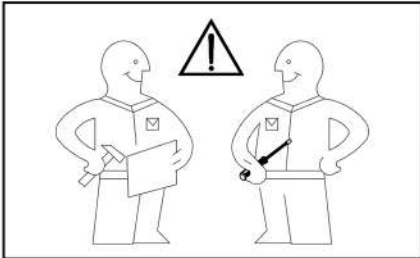

40 DK-210-2F

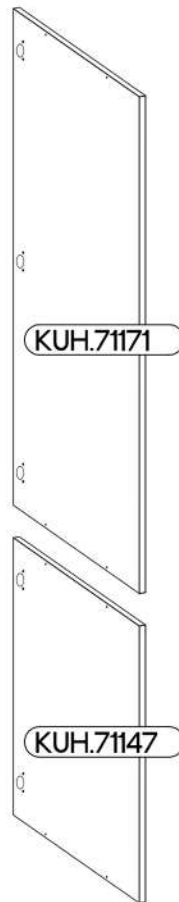
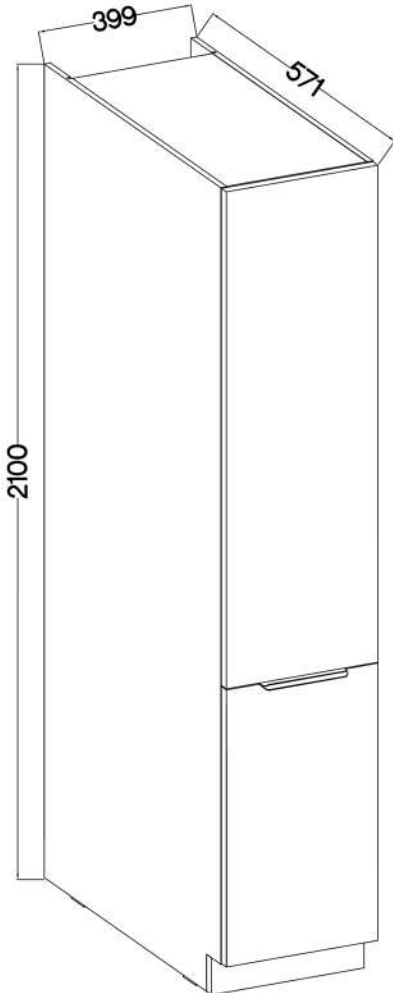
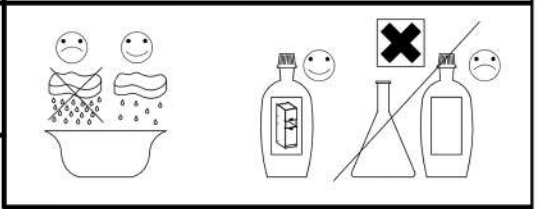

L=192mm	±7/2mm
S	J5
2	4

KUH.71147	713x396x16
KUH.71171	1280x396x16

1

±35/0mm [CD] HG	±3.5x13mm P5	±7/2mm J5
5	10	4

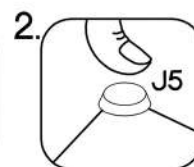
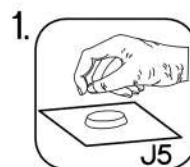
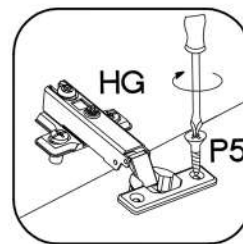
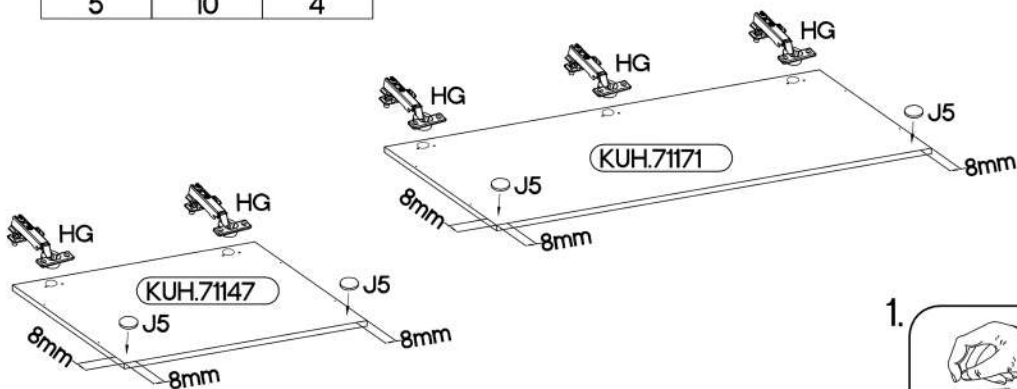

2

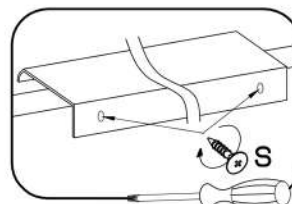
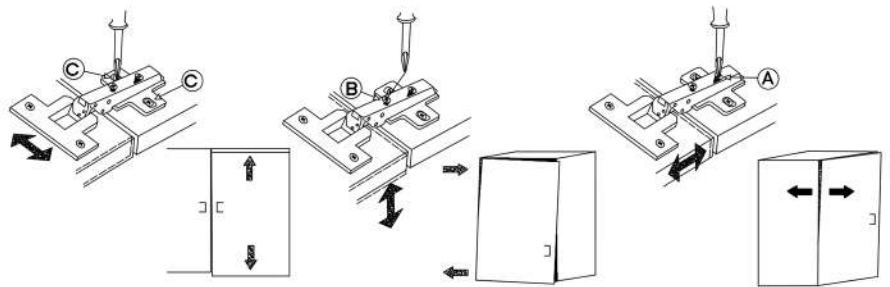
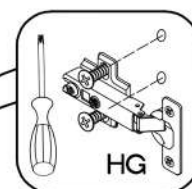
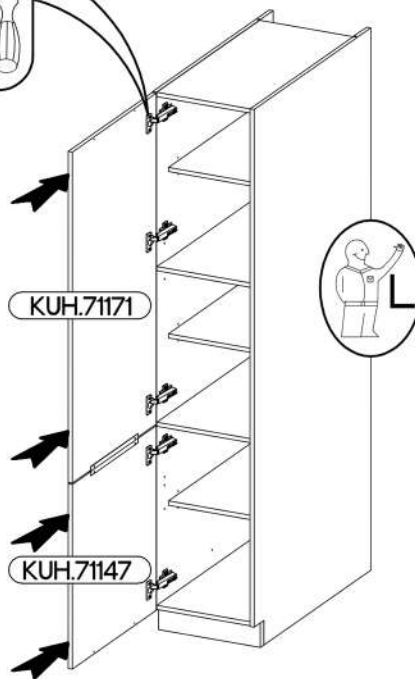
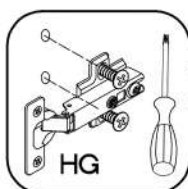

L=192mm
S
2