

Ø10mm

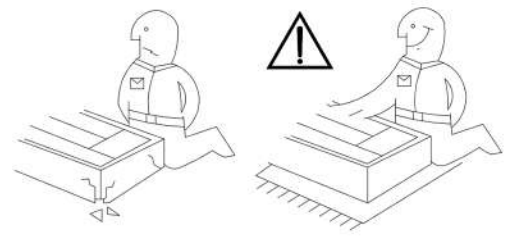

FRISBO 60 DPS-210 1F 3S

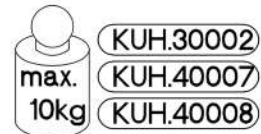
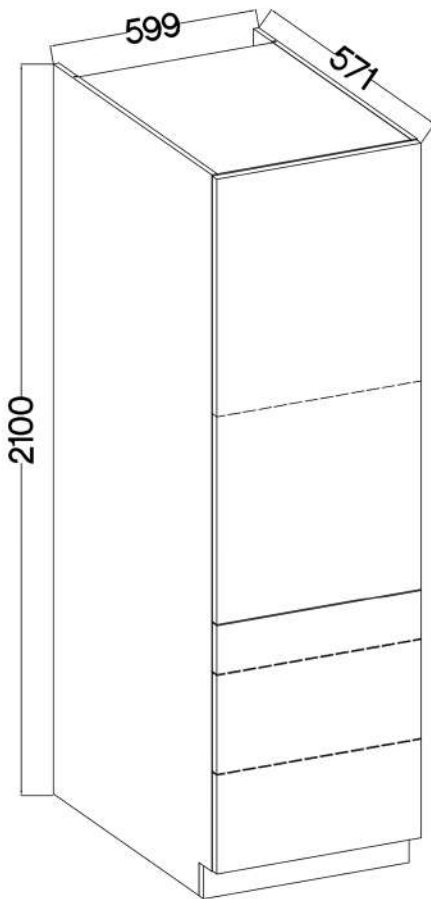

KUH.30002
KUH.40007
KUH.40008

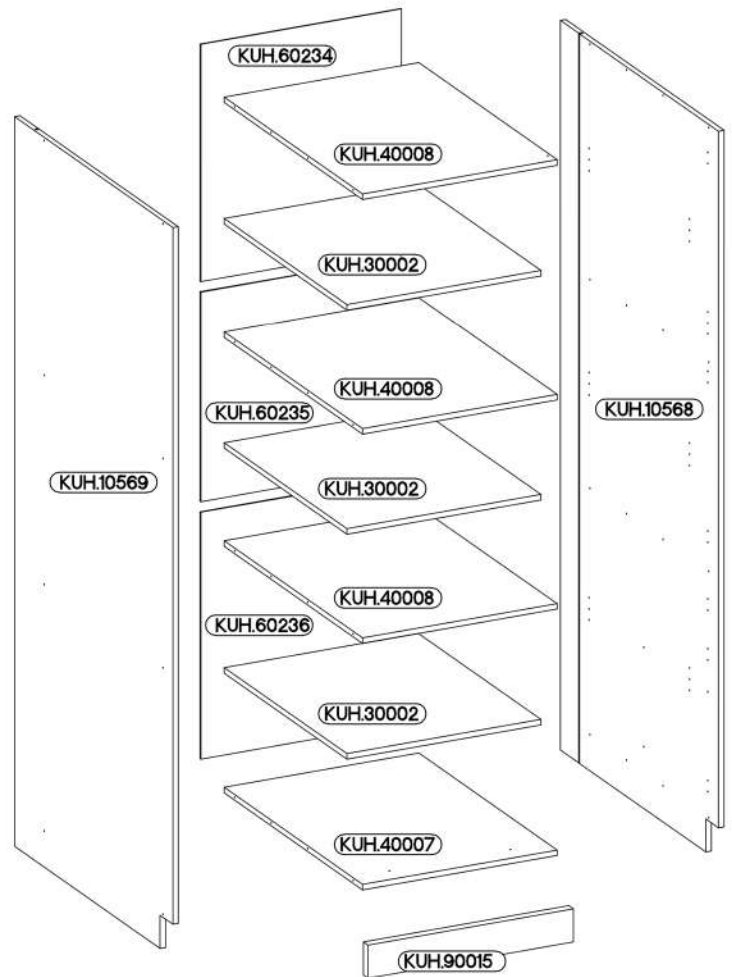



KUH.10568	2095x555x16
KUH.10569	2095x555x16
KUH.30002 x3	566x430x16
KUH.40007	567x485x16
KUH.40008 x3	567x485x16
KUH.60234	681x585x2,5
KUH.60235	603x585x2,5
KUH.60236	708x585x2,5
KUH.90015	599x95x16

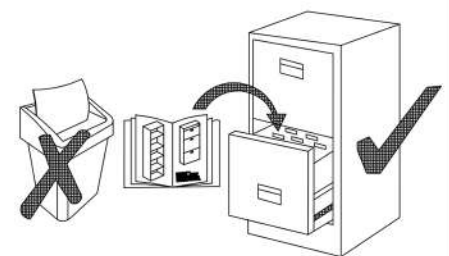

±8x30mm A 16	6,4 x 50mm B 16	 E1 16	 E9 2	6.5x48x16 F2 4	±35/0mm HG 5	
±5/19mm J 12	 L2 8	 L25 1	 O 1	±4.0x45mm P4 2	±3.5x13mm P5 12	±3.0x20mm P7 15-20



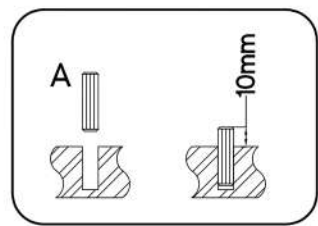
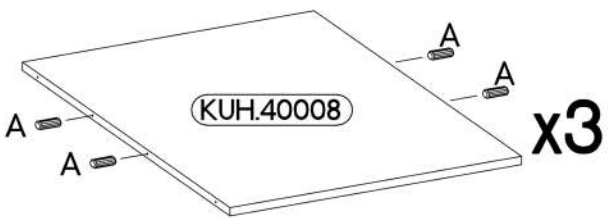
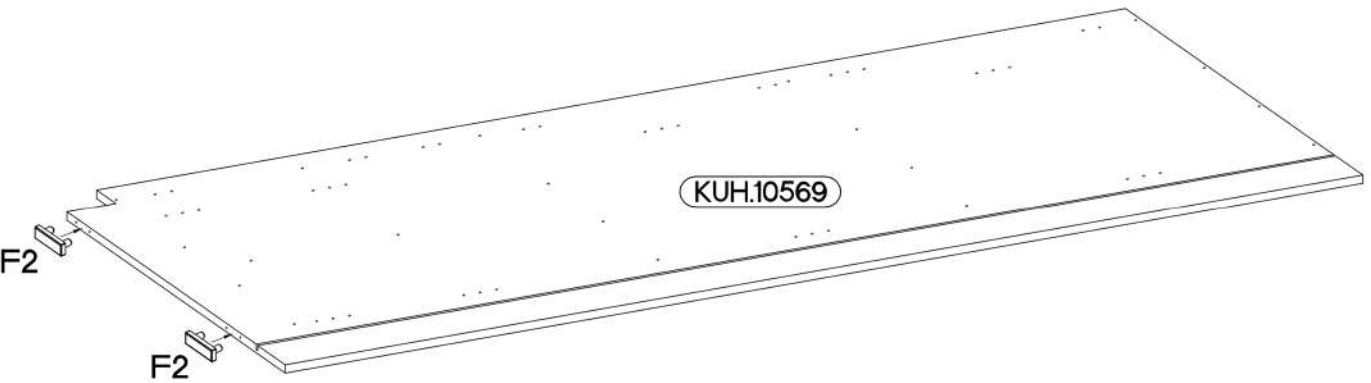
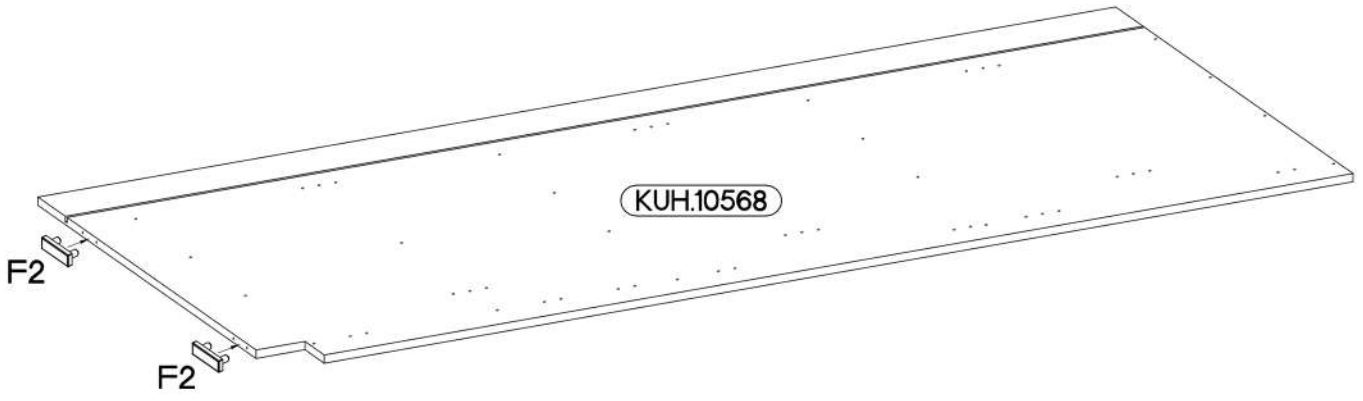
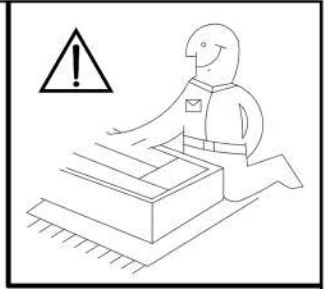
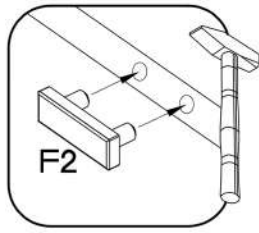

1

6.5x48x16  F2 4	†8x30mm  A 16
---	---





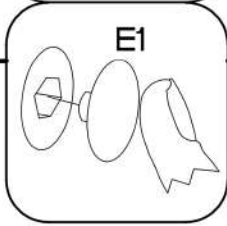
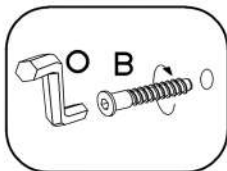
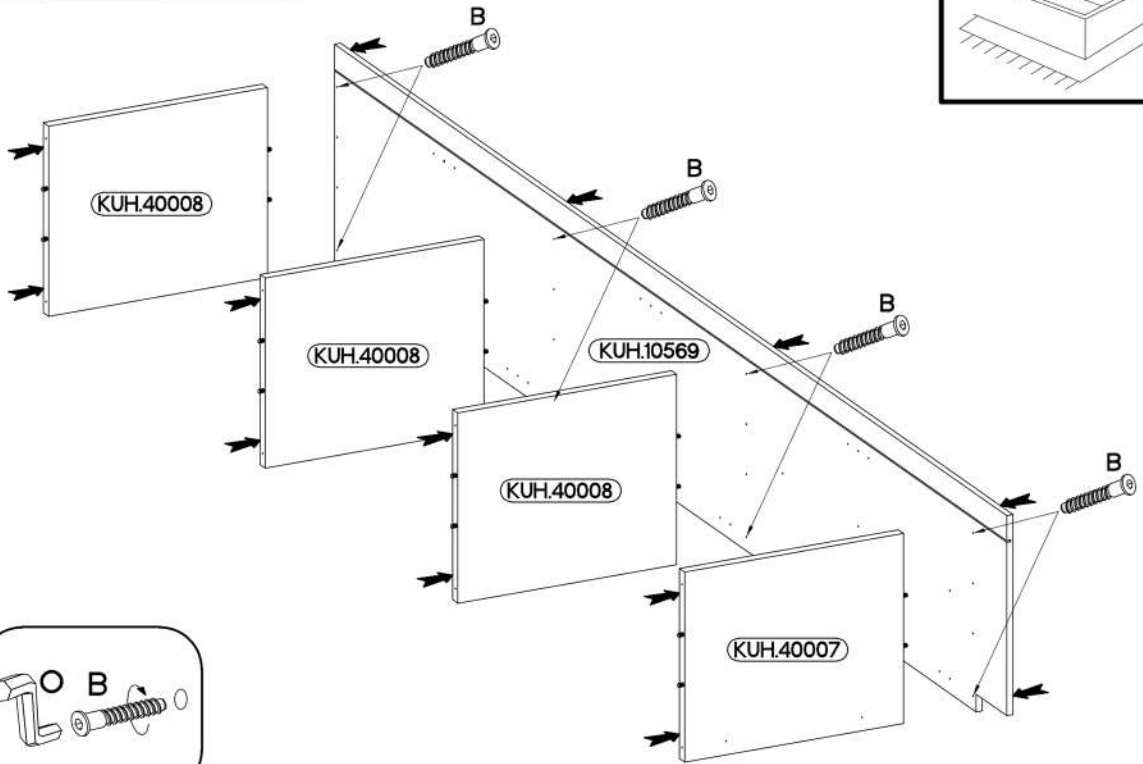

2

6,4 x 50mm		
		
B	O	E1
8	1	8

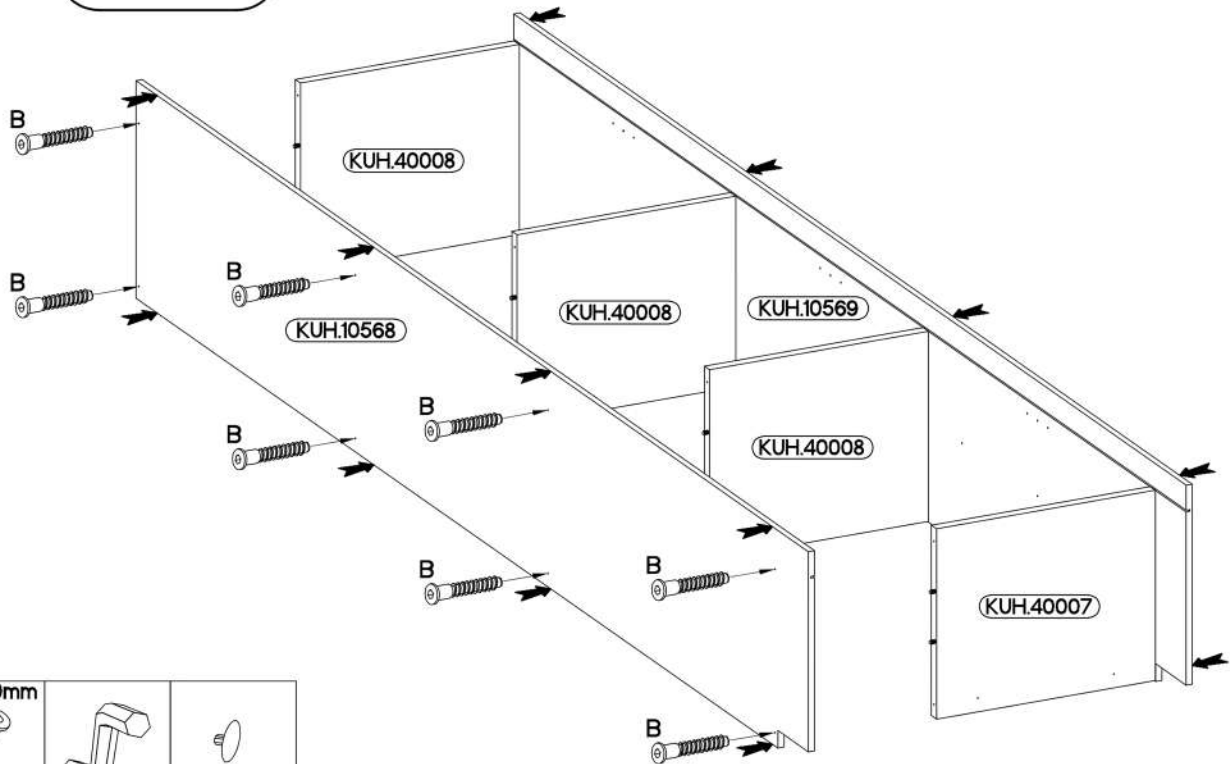

3



6,4 x 50mm		
		
B	O	E1
8	1	8

60 DP-210 2F

60 DPS-210 1F 3S

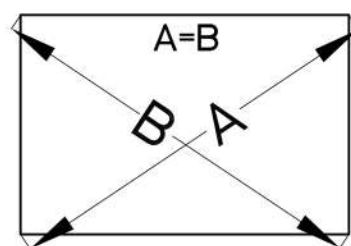
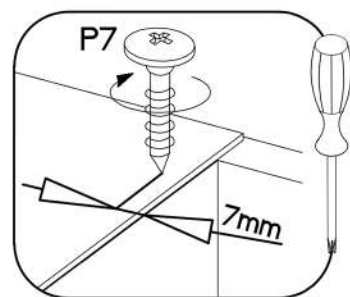
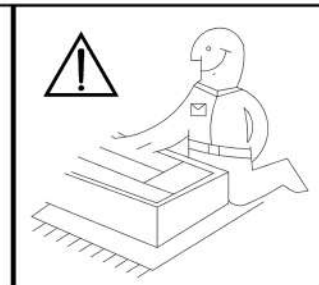
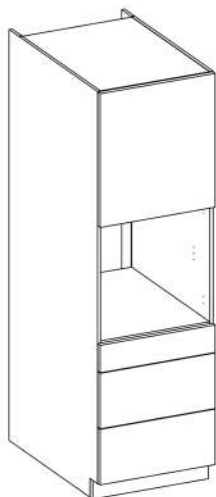
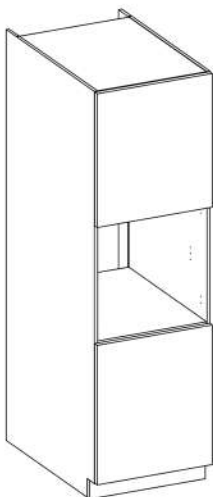

4

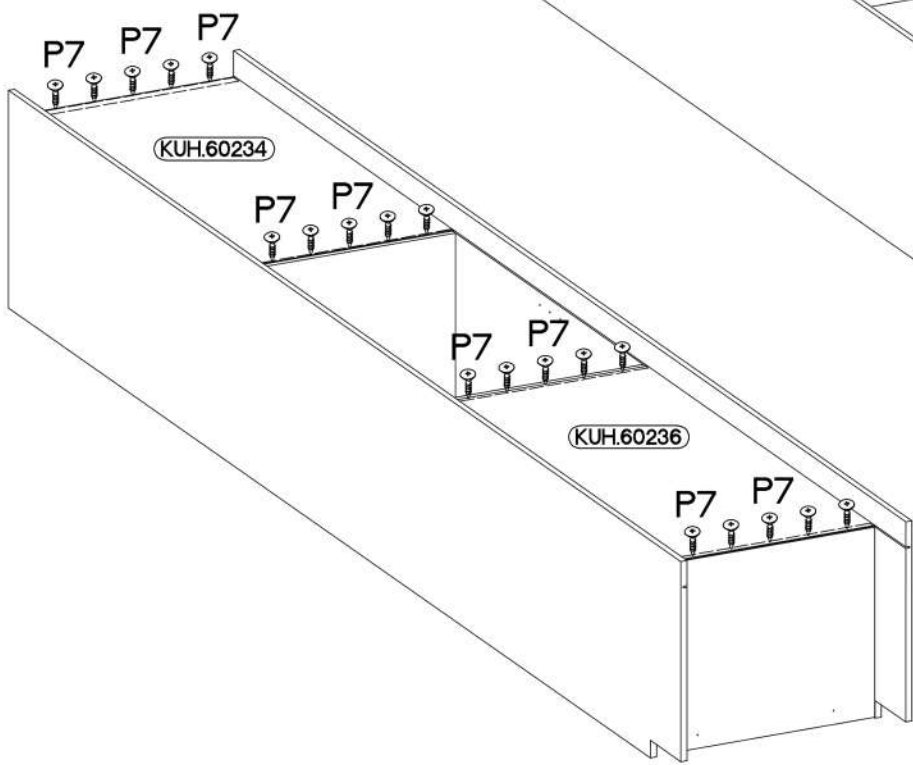
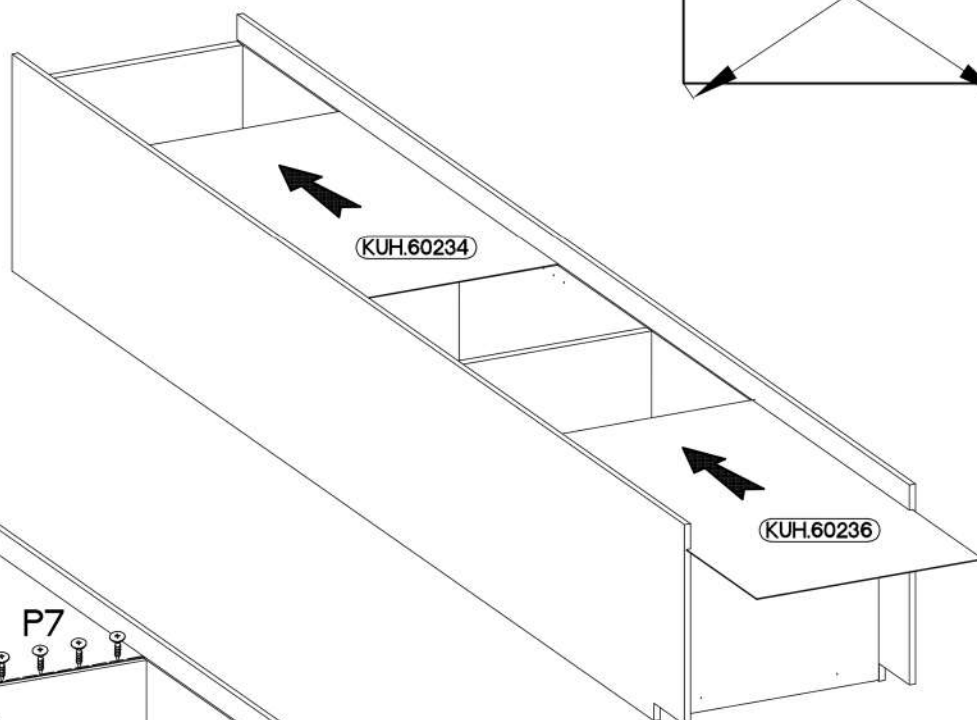

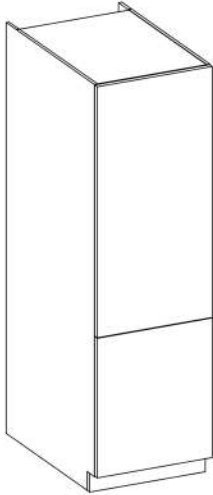

60 DK-210 2F

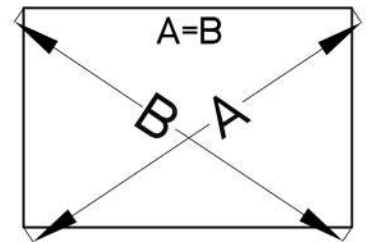
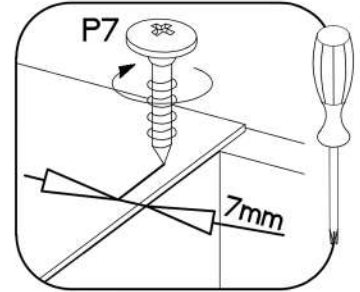
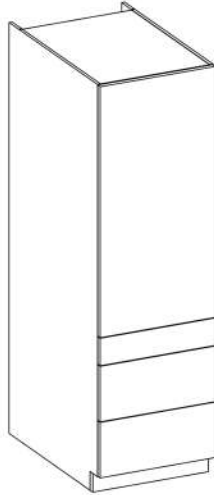

60 DKS-210 1F 3S



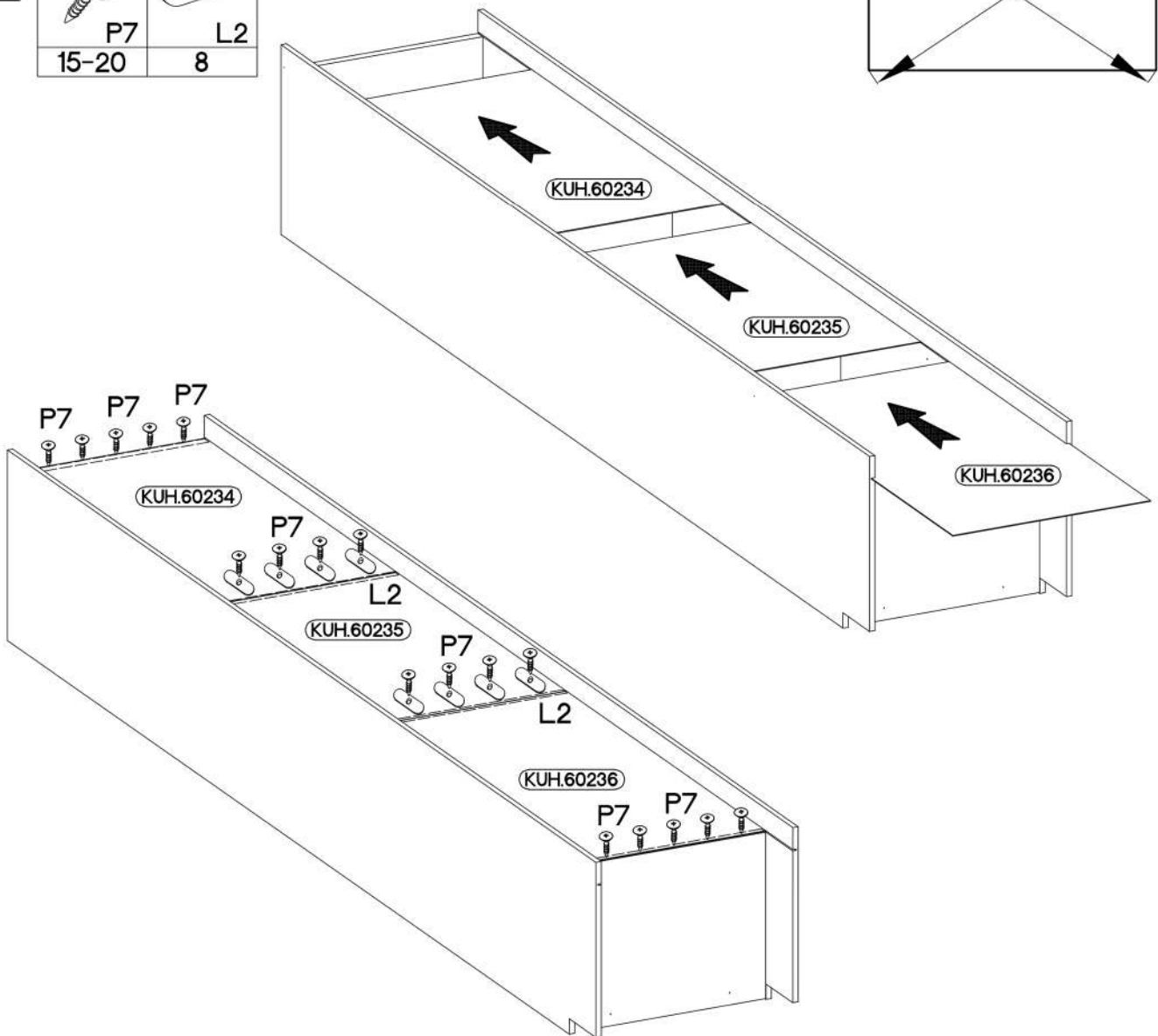

5

+3.0x20mm	
	
P7	L2
15-20	8



6

 †4.0x45mm P4 2	 E9 2
---	--

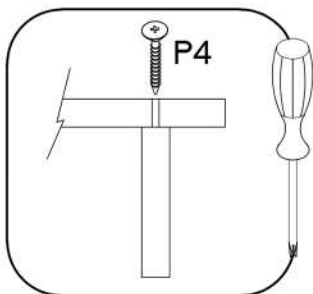
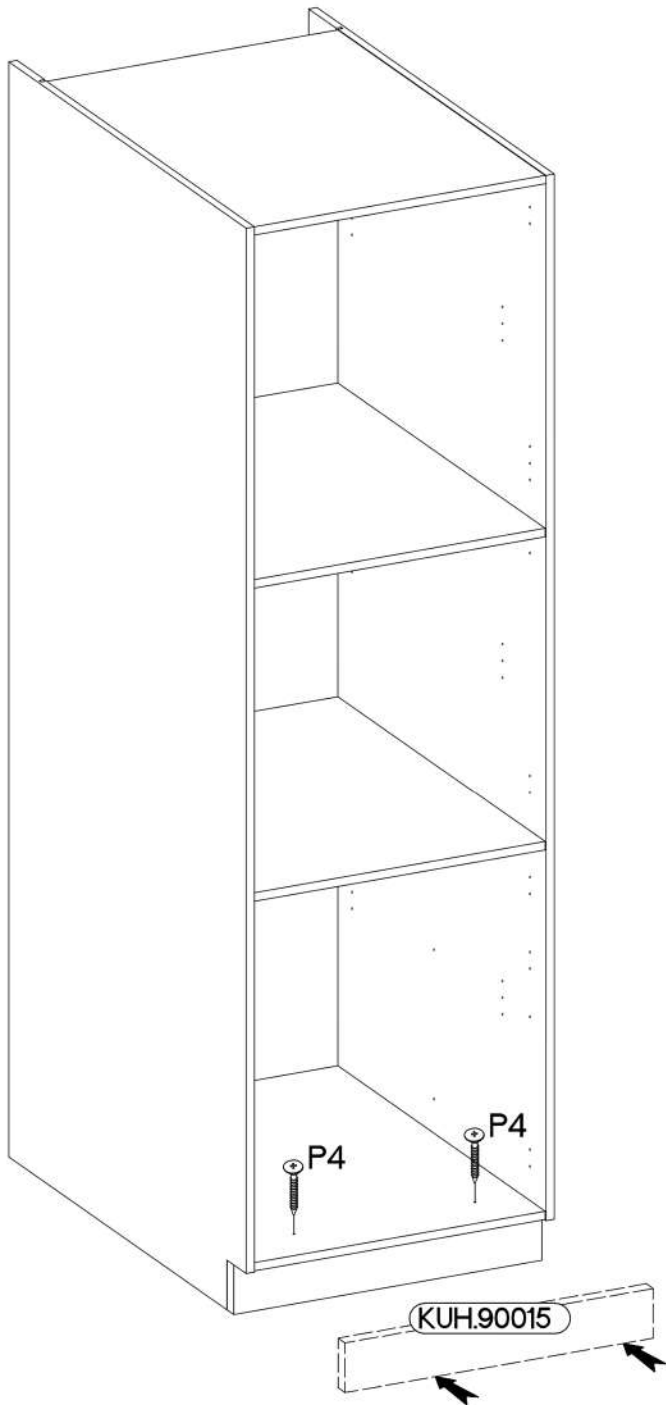

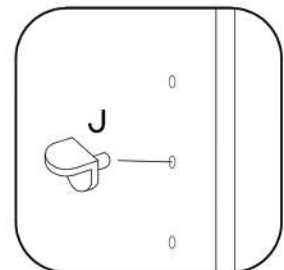
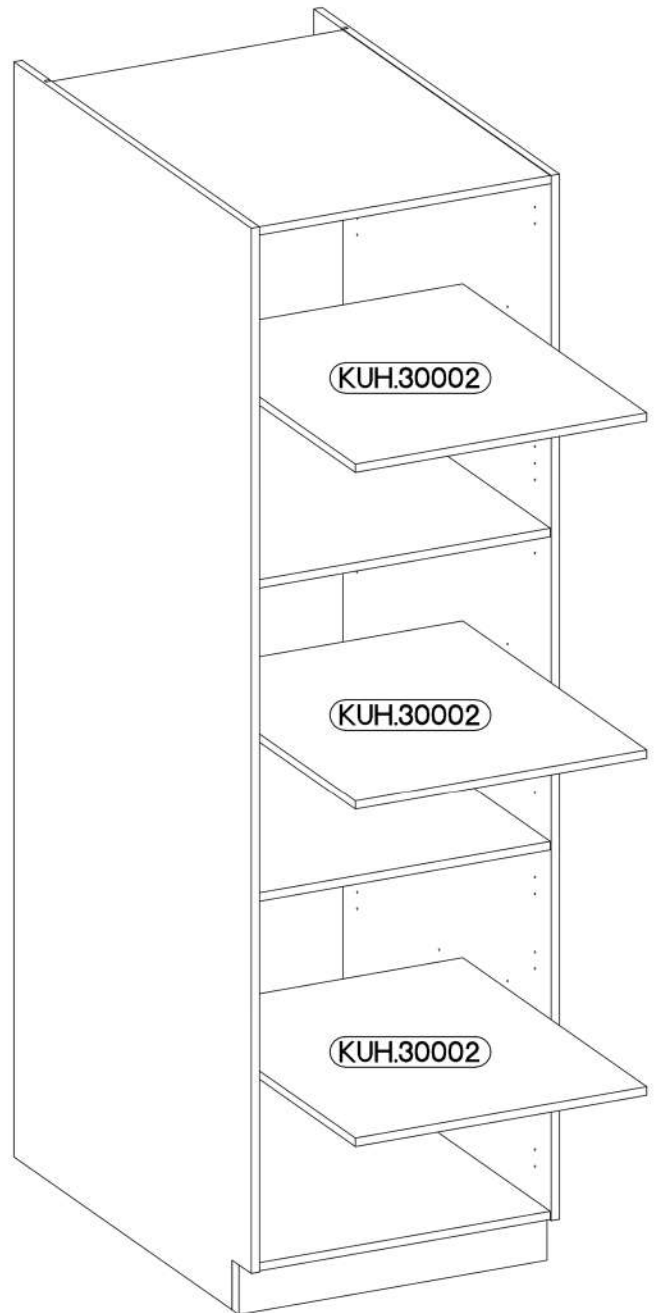

7

 †5/19mm J 12
--

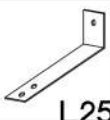

8

 L25 1	 3.5x13mm P5 2
---	--

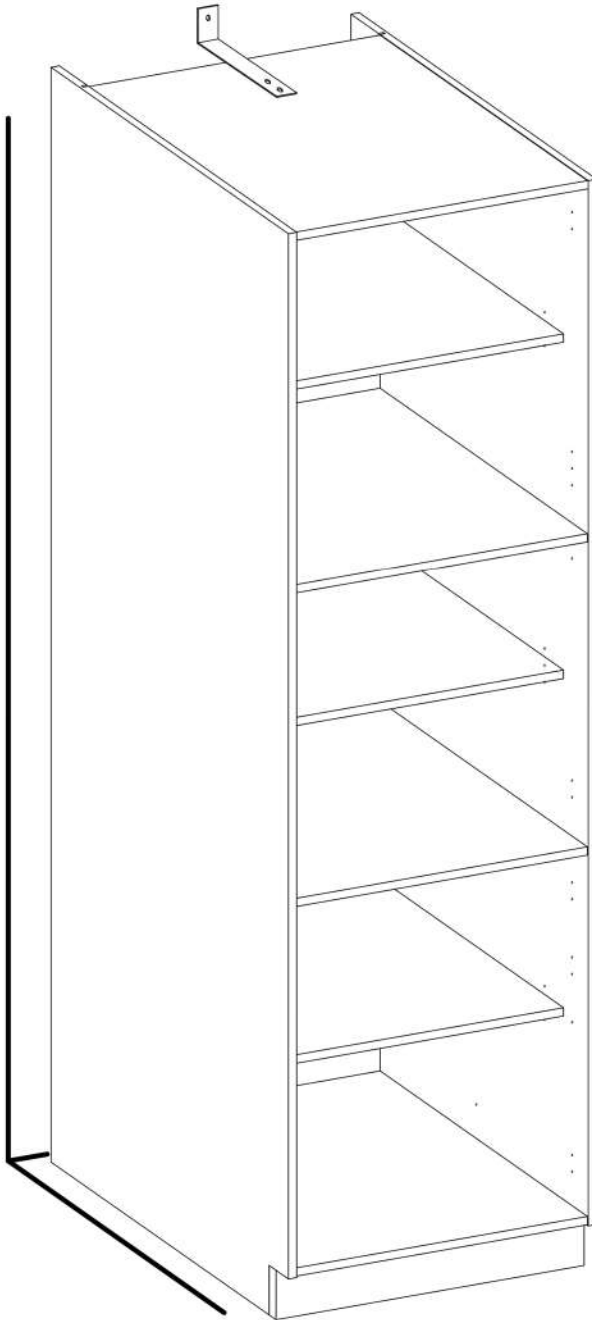
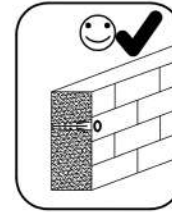
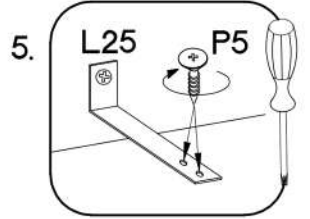
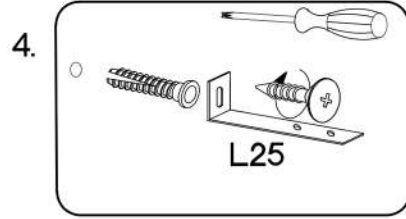
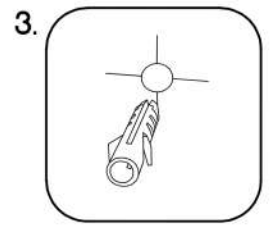
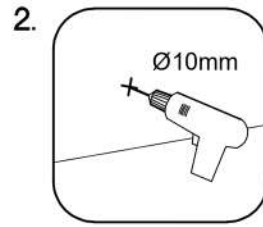
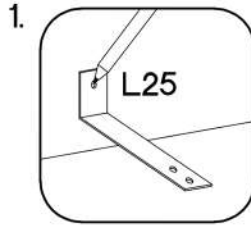

	<p>Ø5mm Ø10mm</p>		
	<p>0.5h</p>	<p>60 DPS-210-1F 3S</p>	

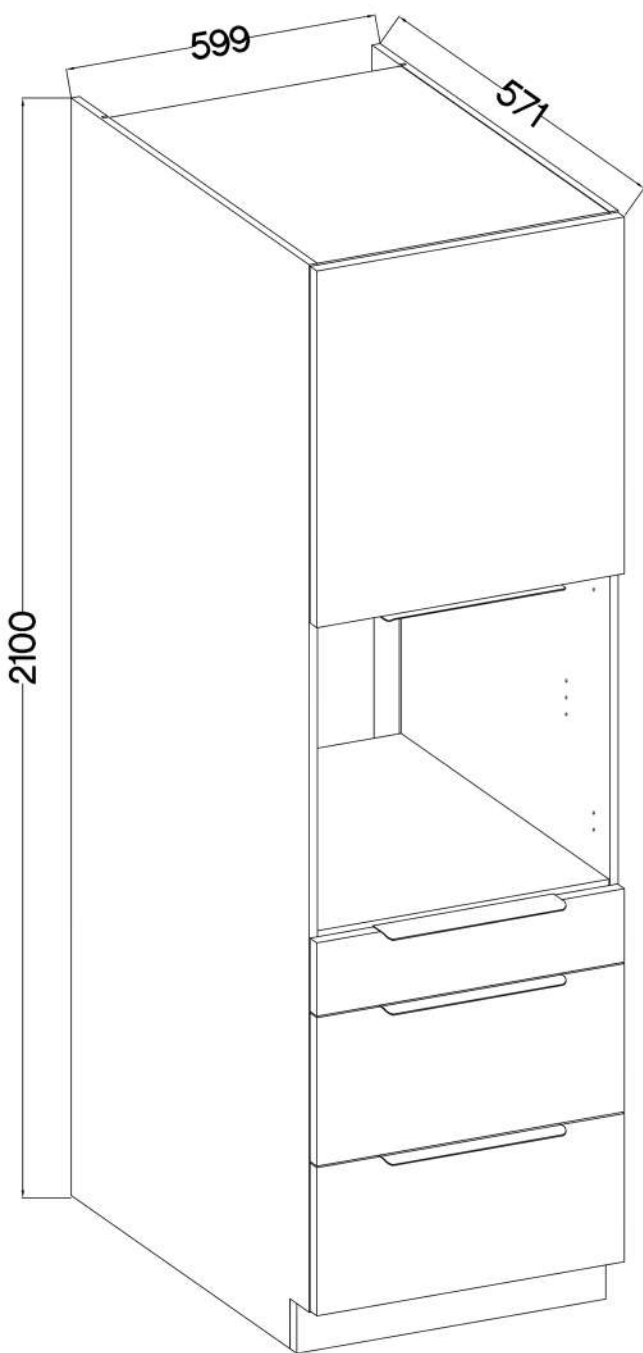

L=320mm	+7/2mm
S	J5
1	2

KUH.71174	682x596x16
-----------	------------

1

±35/0mm [CD] HG 2	±3.5x13mm P5 4	±7/2mm J5 2
-------------------------	----------------------	-------------------

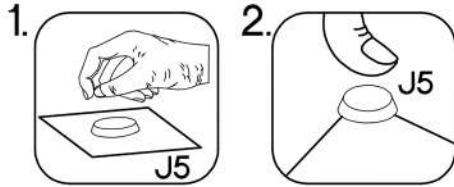
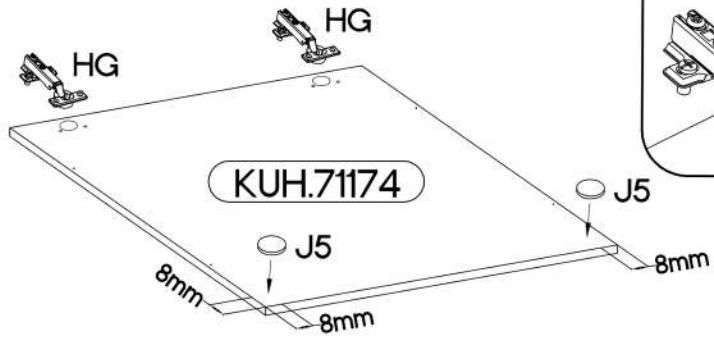

2

L=320mm S 1

