

# FRISBO 60 LO-210 2F

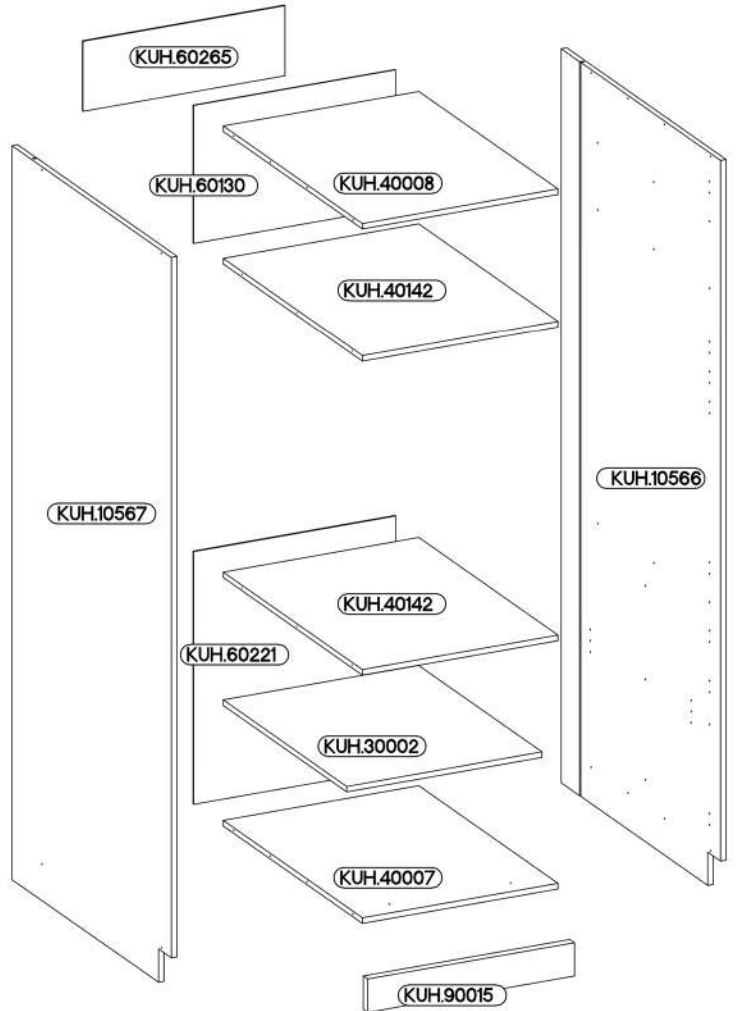

KUH.10566	2095x555x16
KUH.10567	2095x555x16
KUH.30002	566x430x16
KUH.40007	567x485x16
KUH.40008	567x485x16
KUH.40142 x2	567x485x16
KUH.60130	393x585x2,5
KUH.60221	721x585x2,5
KUH.60265	200x585x2,5
KUH.90015	599x95x16

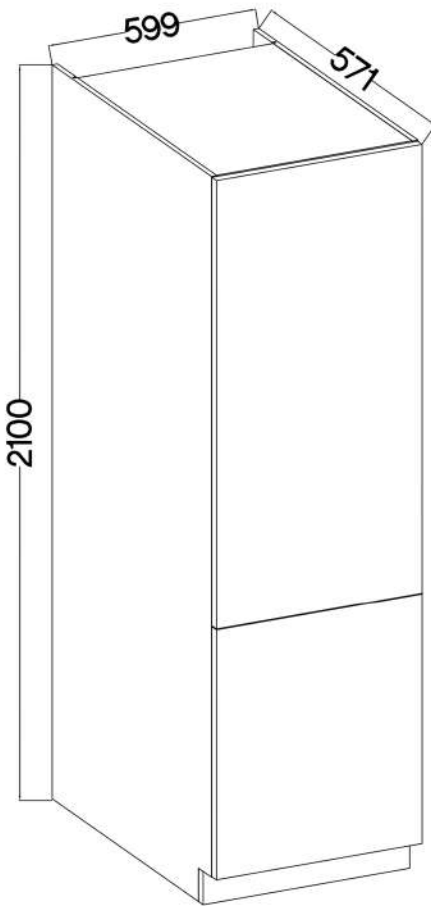

<b>A</b>	<b>B</b>	<b>C</b>
8	8	12

<b>D2</b>	<b>E</b>	<b>E1</b>	<b>E9</b>	<b>F2</b>	<b>HG</b>	<b>J</b>
12	12	8	2	4	5	4
<b>L25</b>	<b>O</b>	<b>P1</b>	<b>P4</b>	<b>P5</b>	<b>P7</b>	<b>T4</b>
1	1	16	2	12	15-20	4

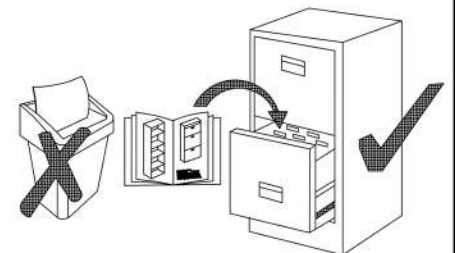

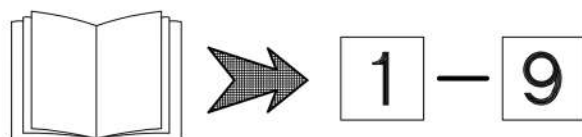
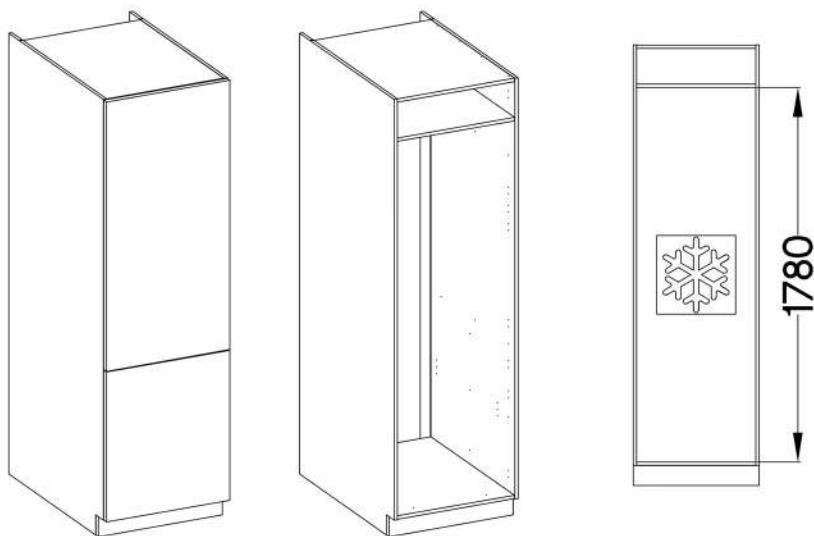

## WARIANT B

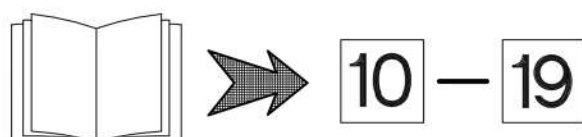
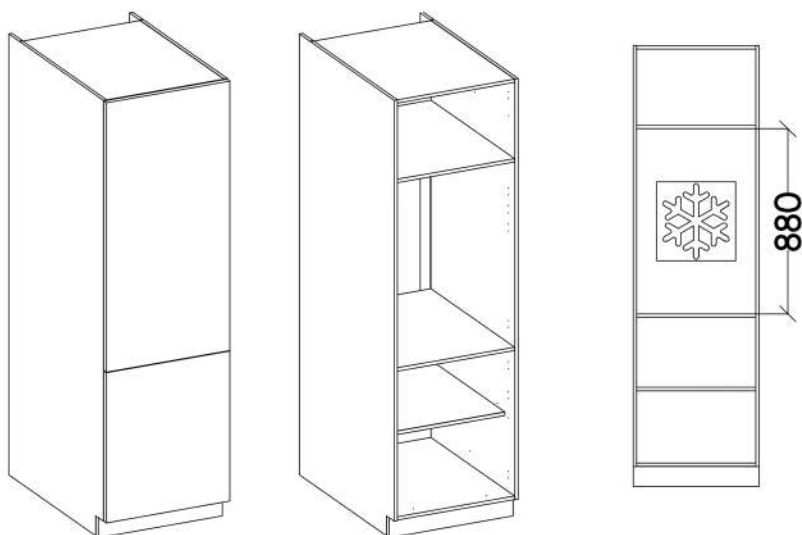

# 1

## WARIANT A

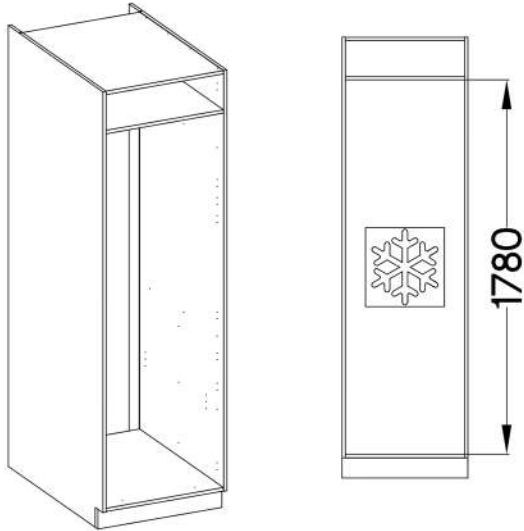

 A	 F2
8 L=20mm	4 H5/H2mm
 D2	 C
6	6

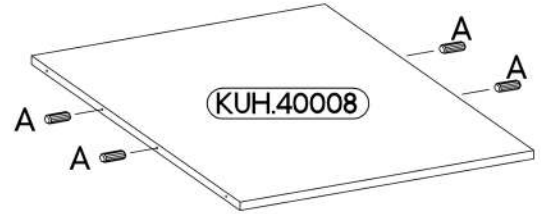
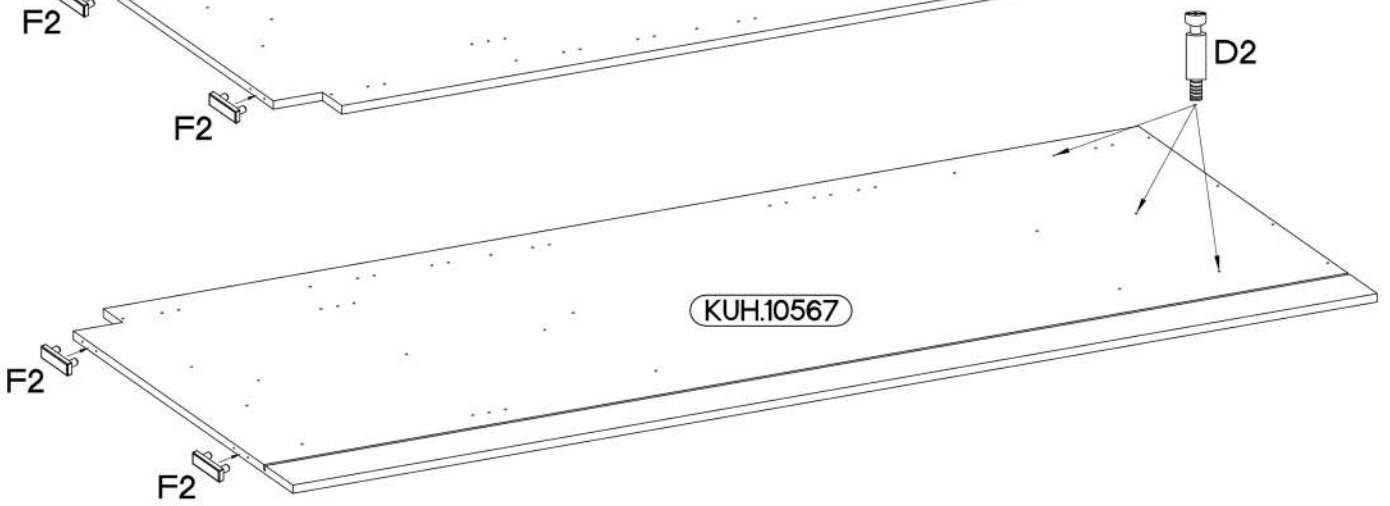
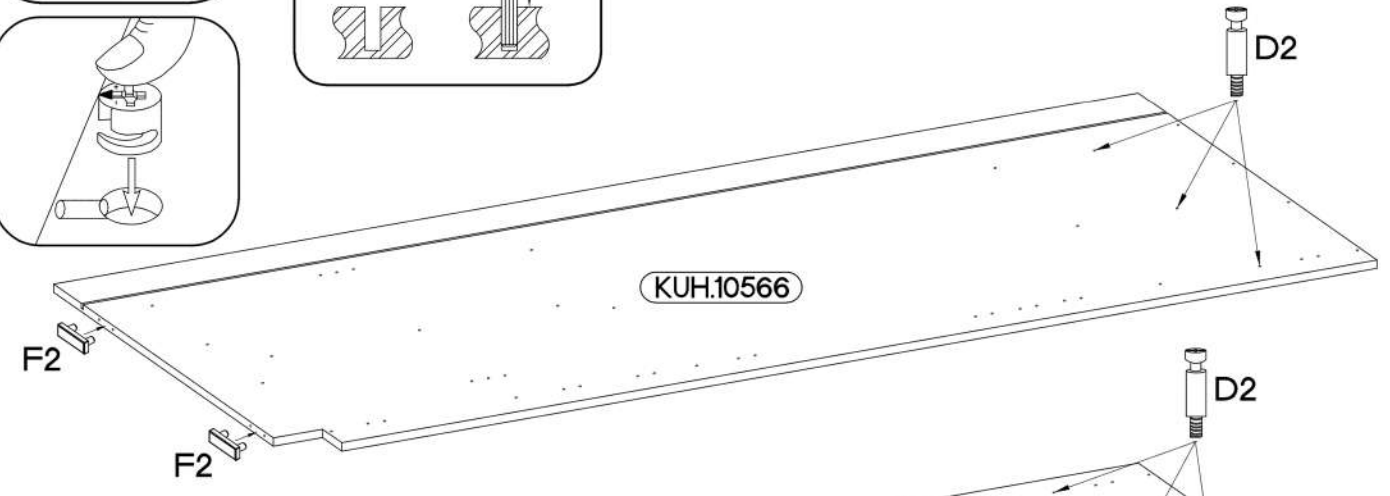
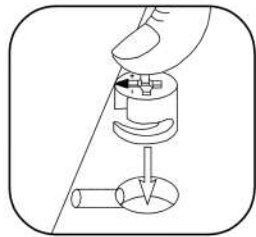
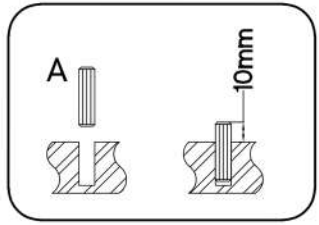
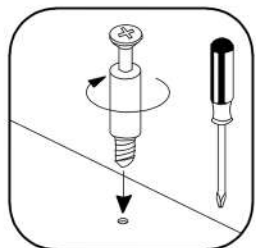
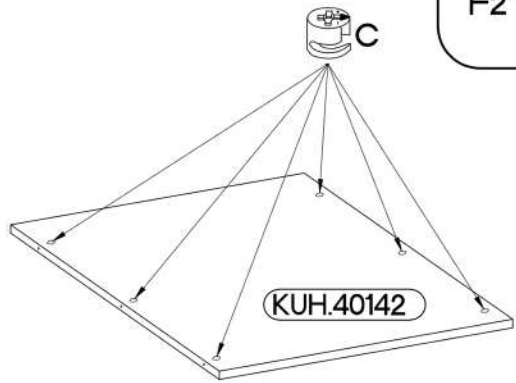
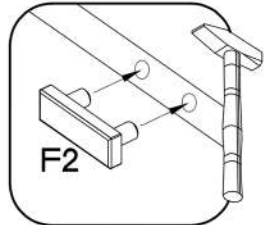
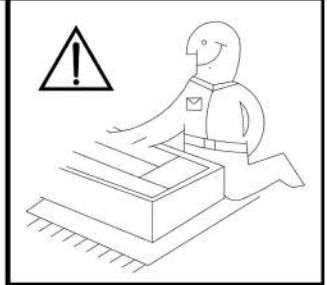

# 2

6,4 x 50mm

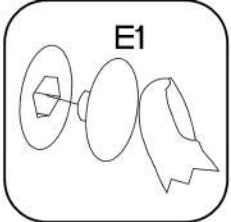
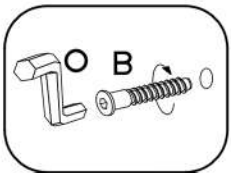
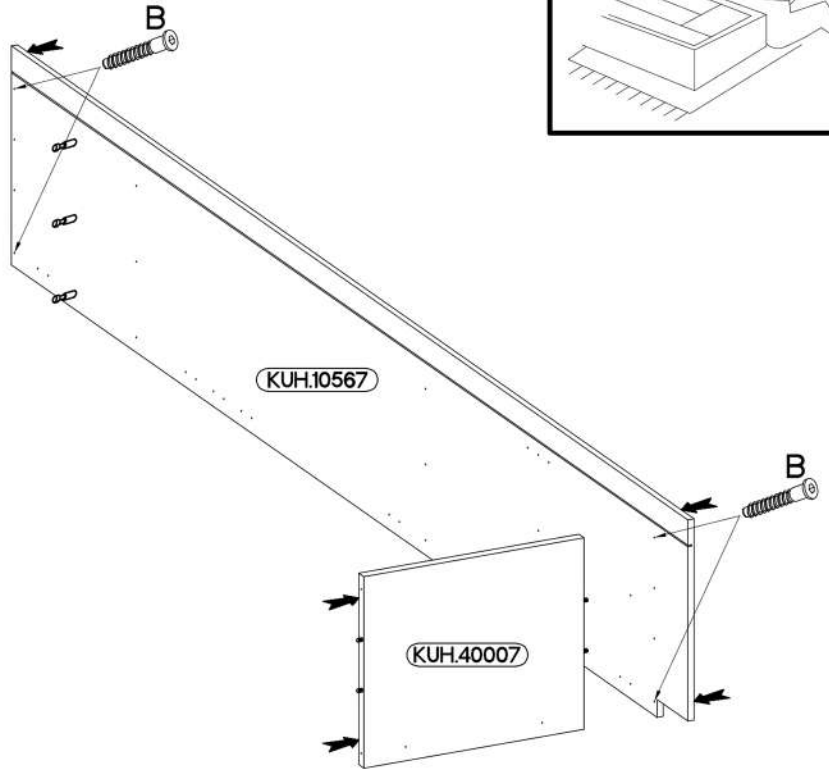
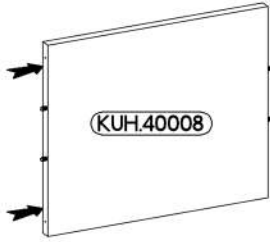
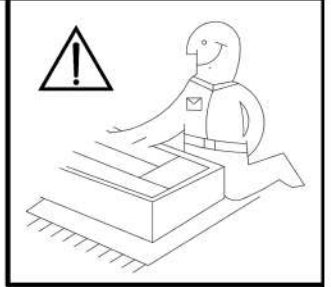
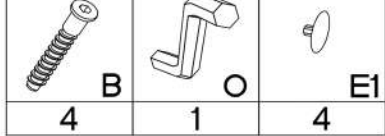



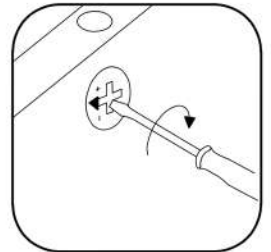
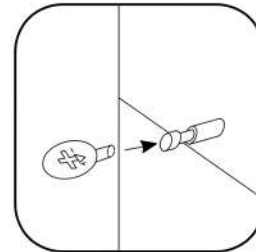
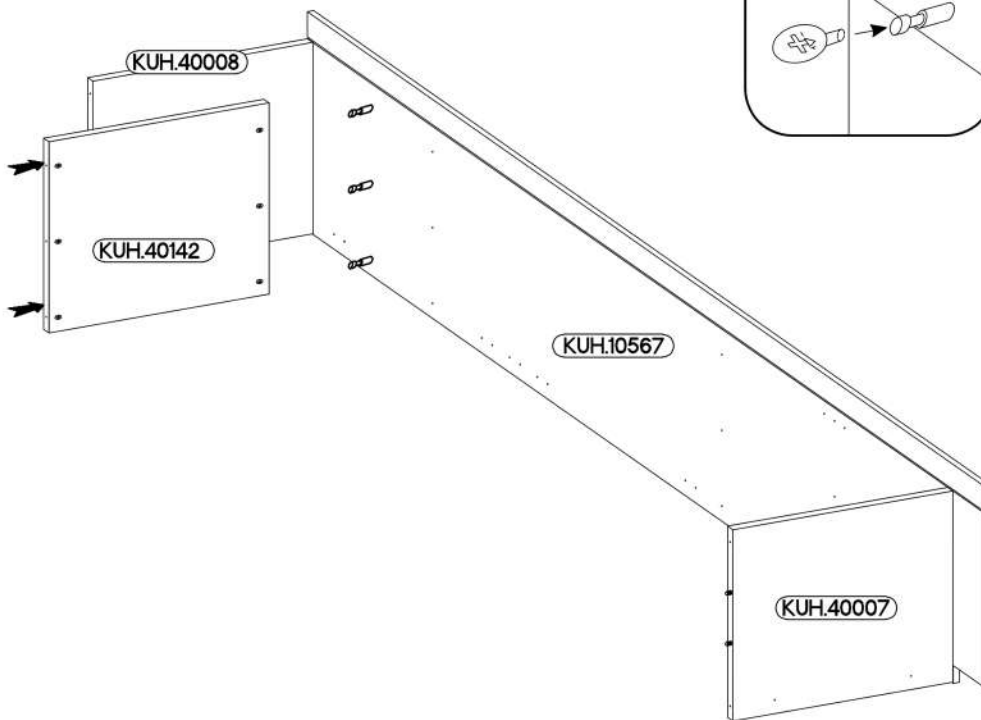

# 3





# 4

6,4 x 50mm

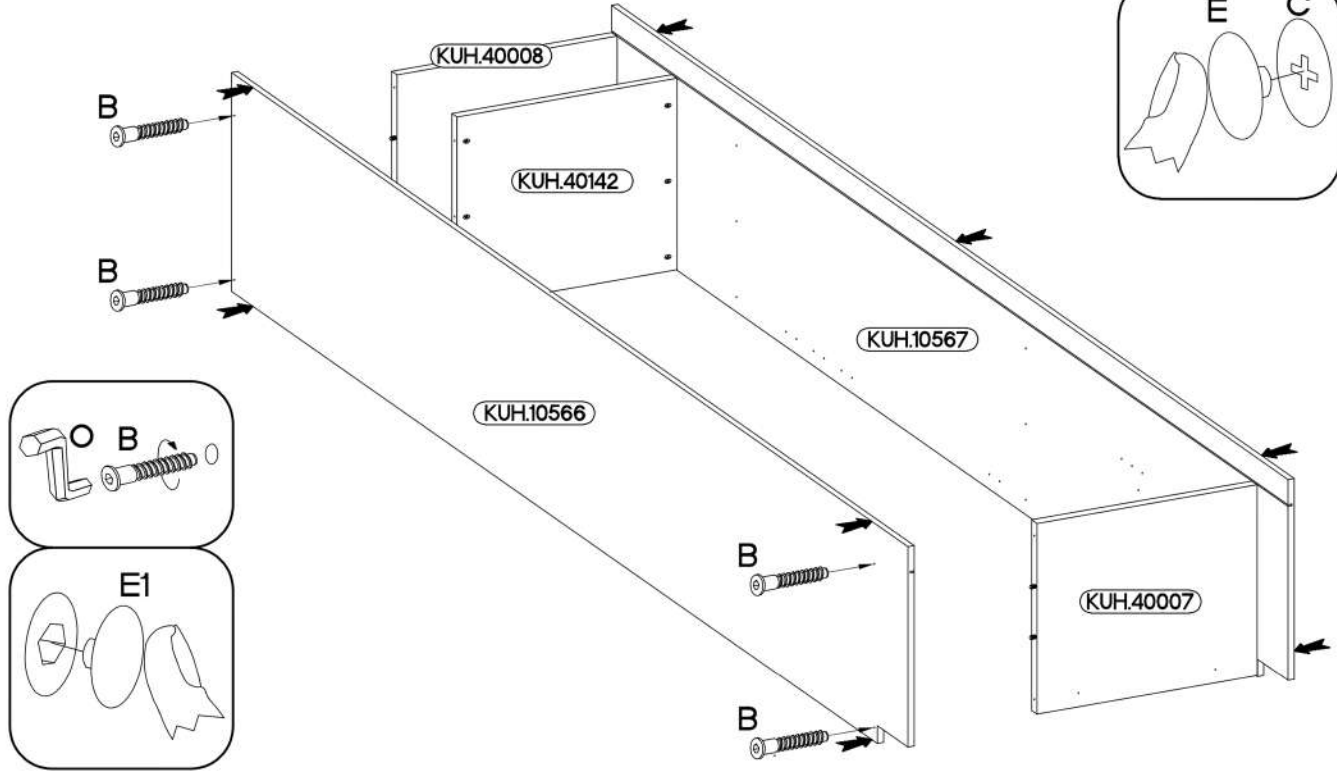
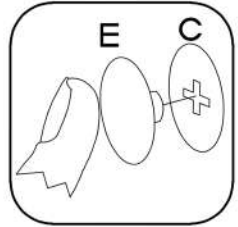
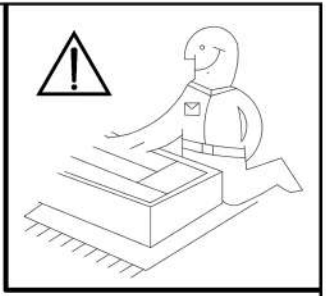
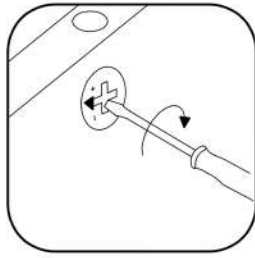
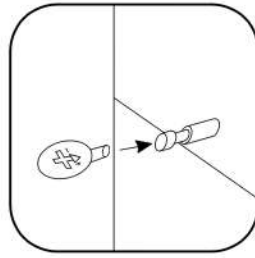
			
B	O	E1	E
4	1	4	6



# 5

	
T4	P1
4	16

4.0x16mm

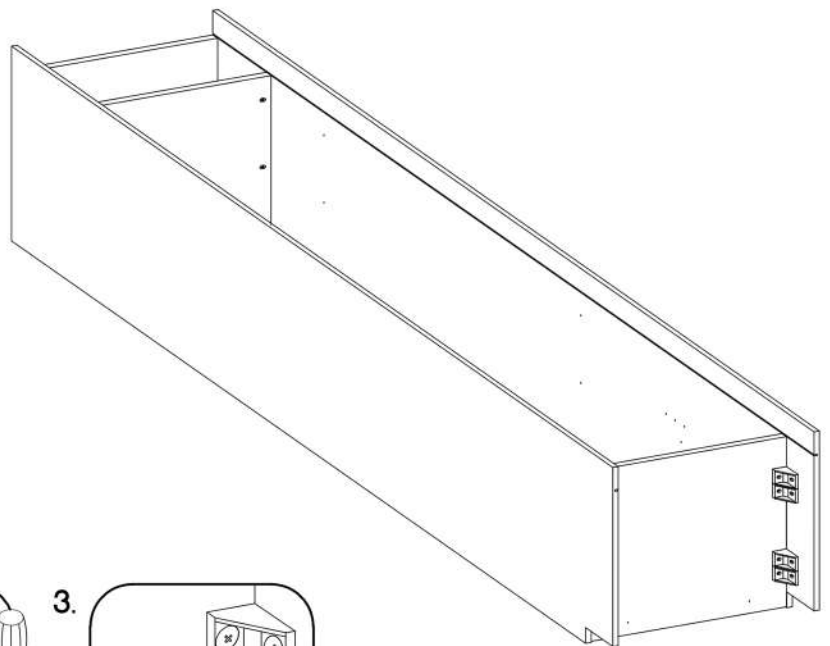
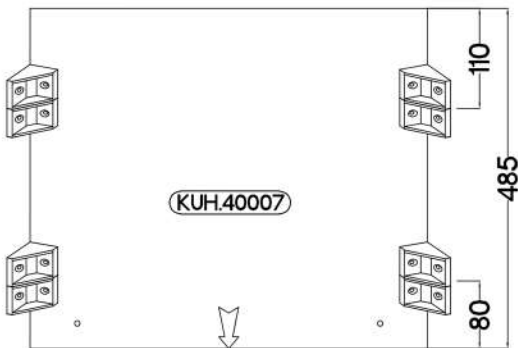

- 
- 
-

6

∅3.0x20mm



P7

8-10

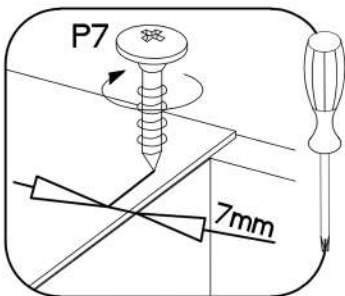
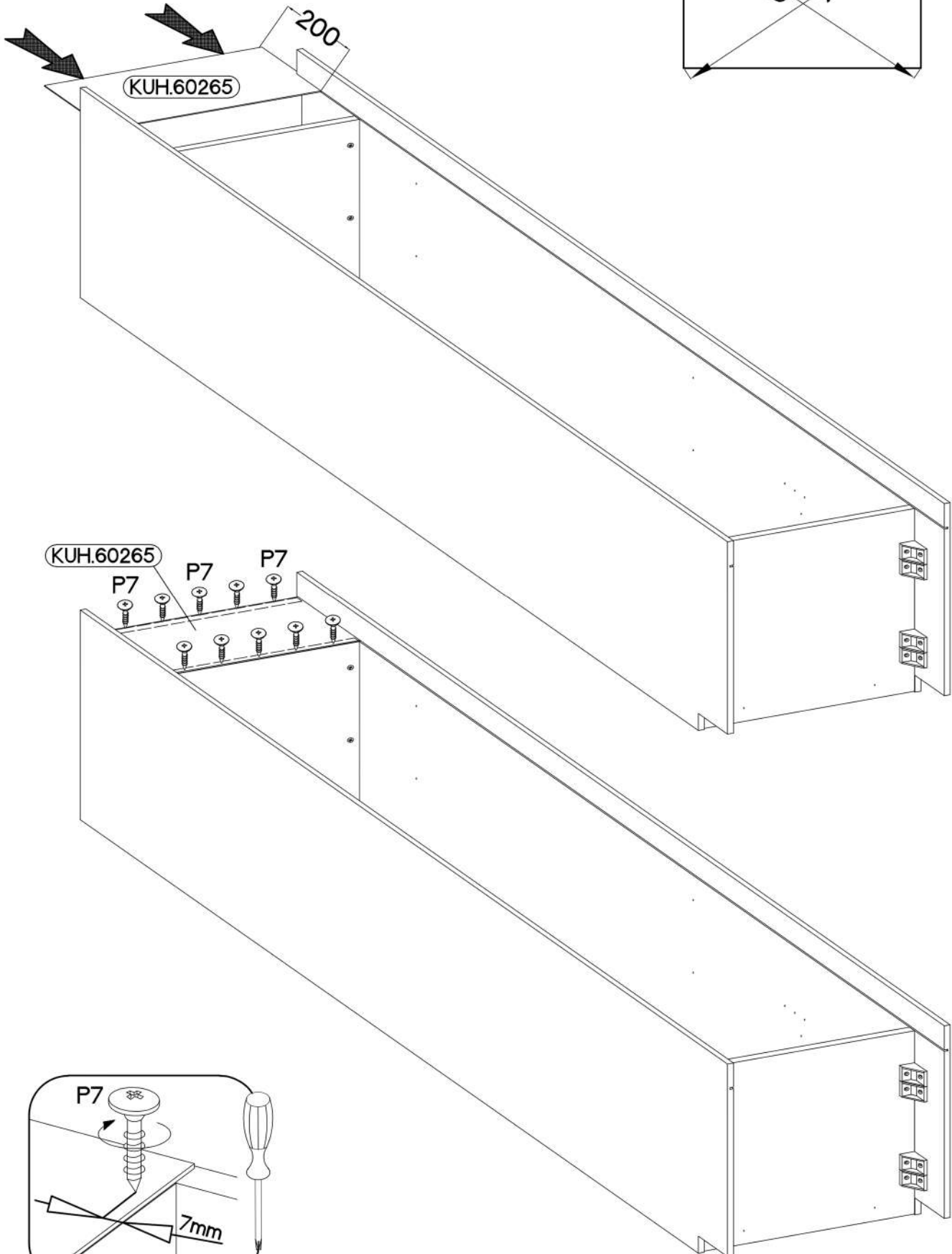
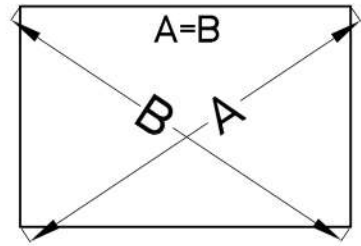

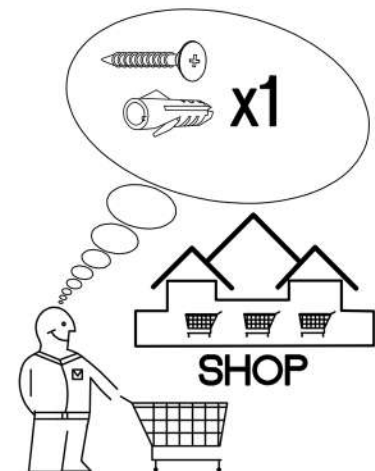
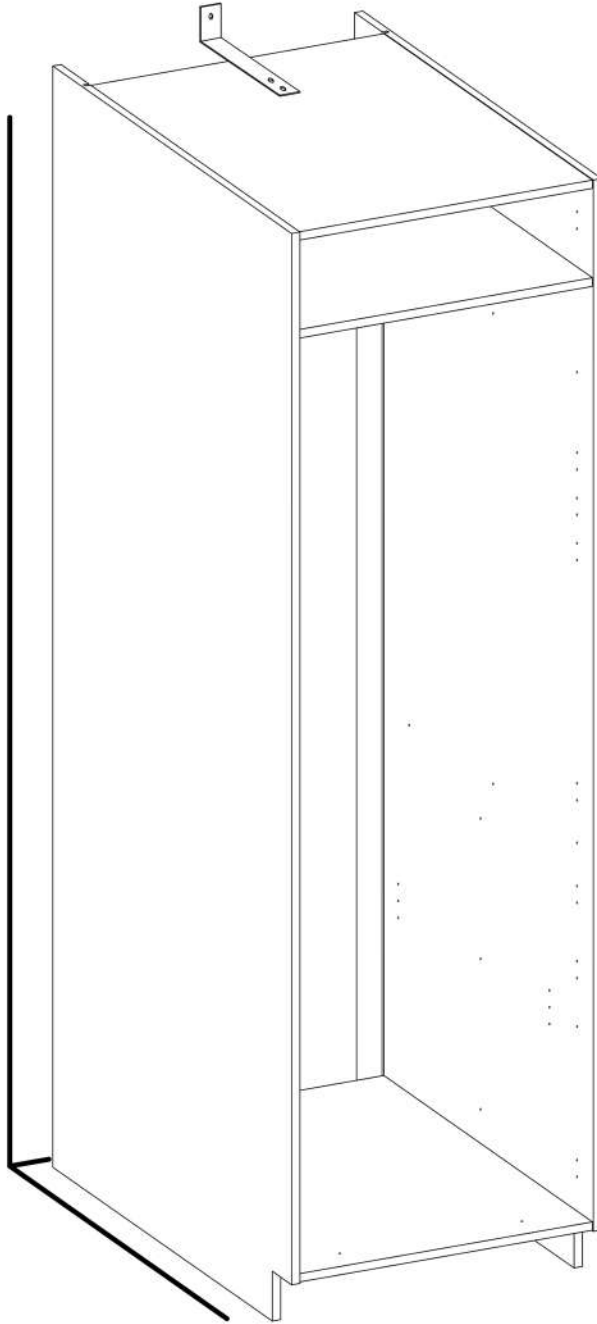
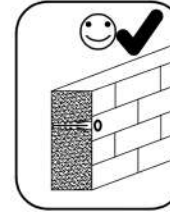
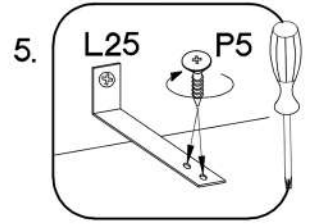
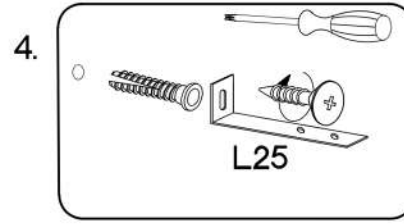
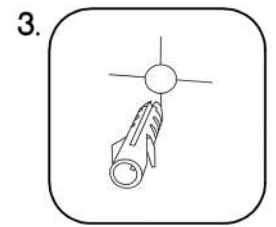
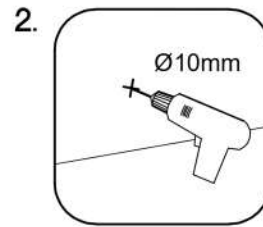
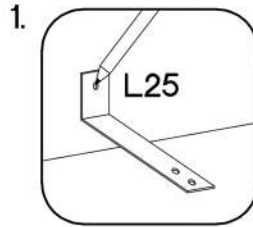
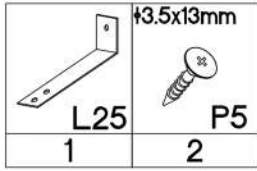

7

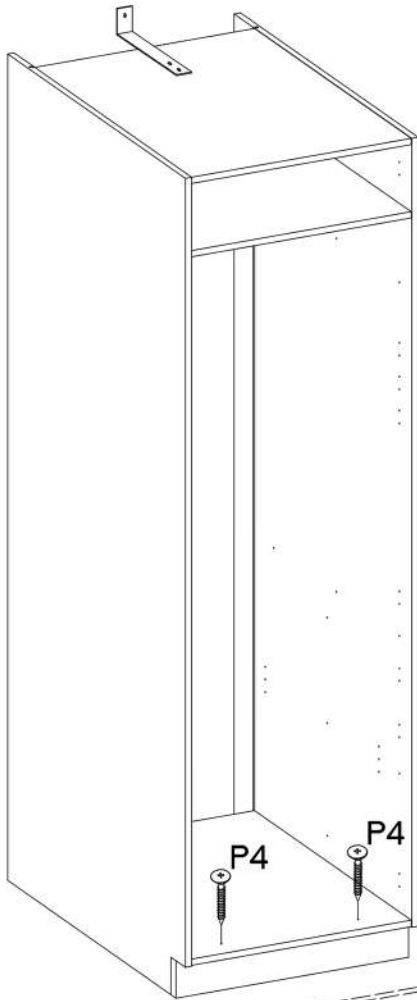

8



4.0x45mm		
	P4	E9
	2	2

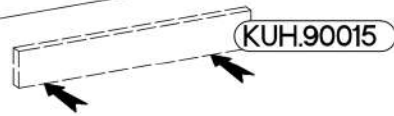
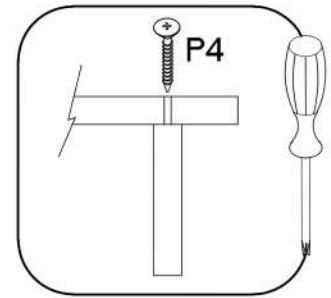

9

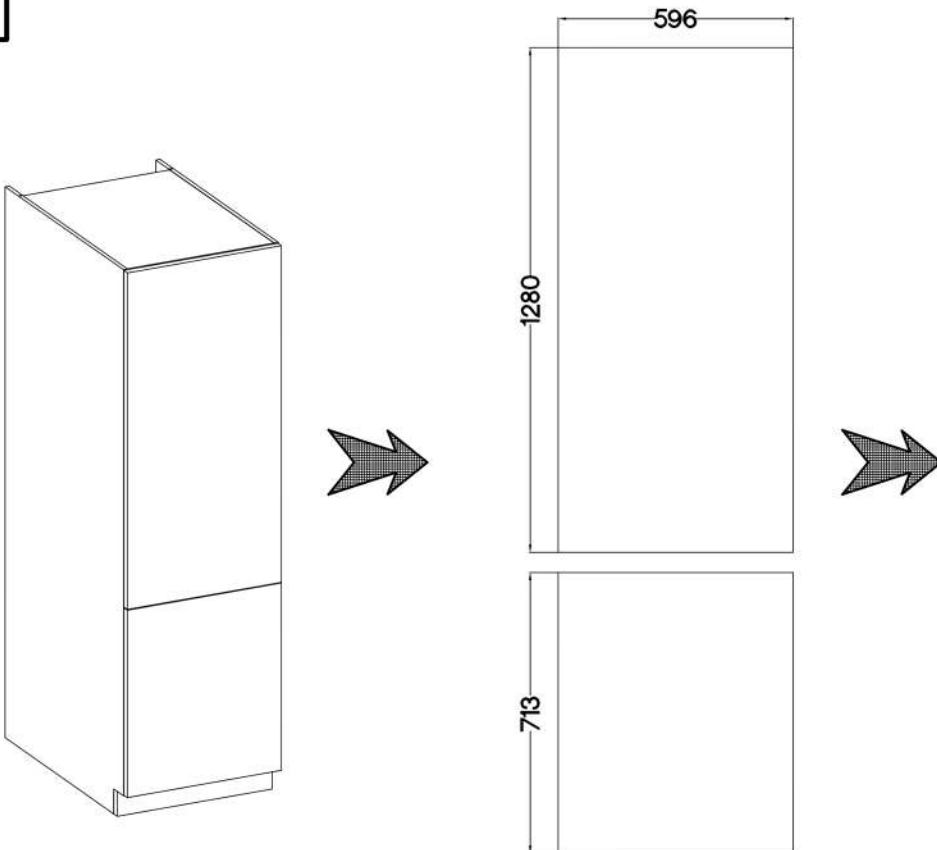

# 10

## WARIANT B

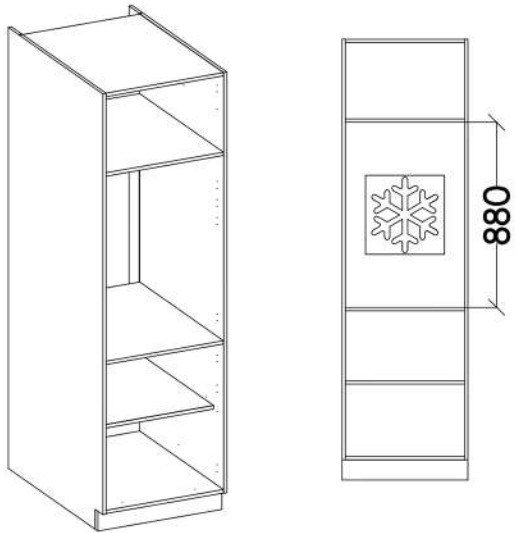

 A	 F2
8 L=20mm	4 H5/H2mm
 D2	 C
12	12

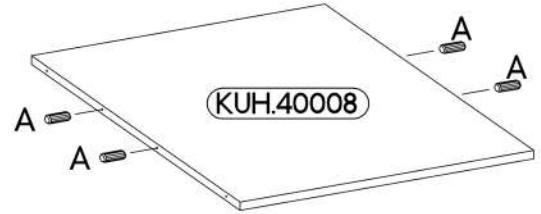
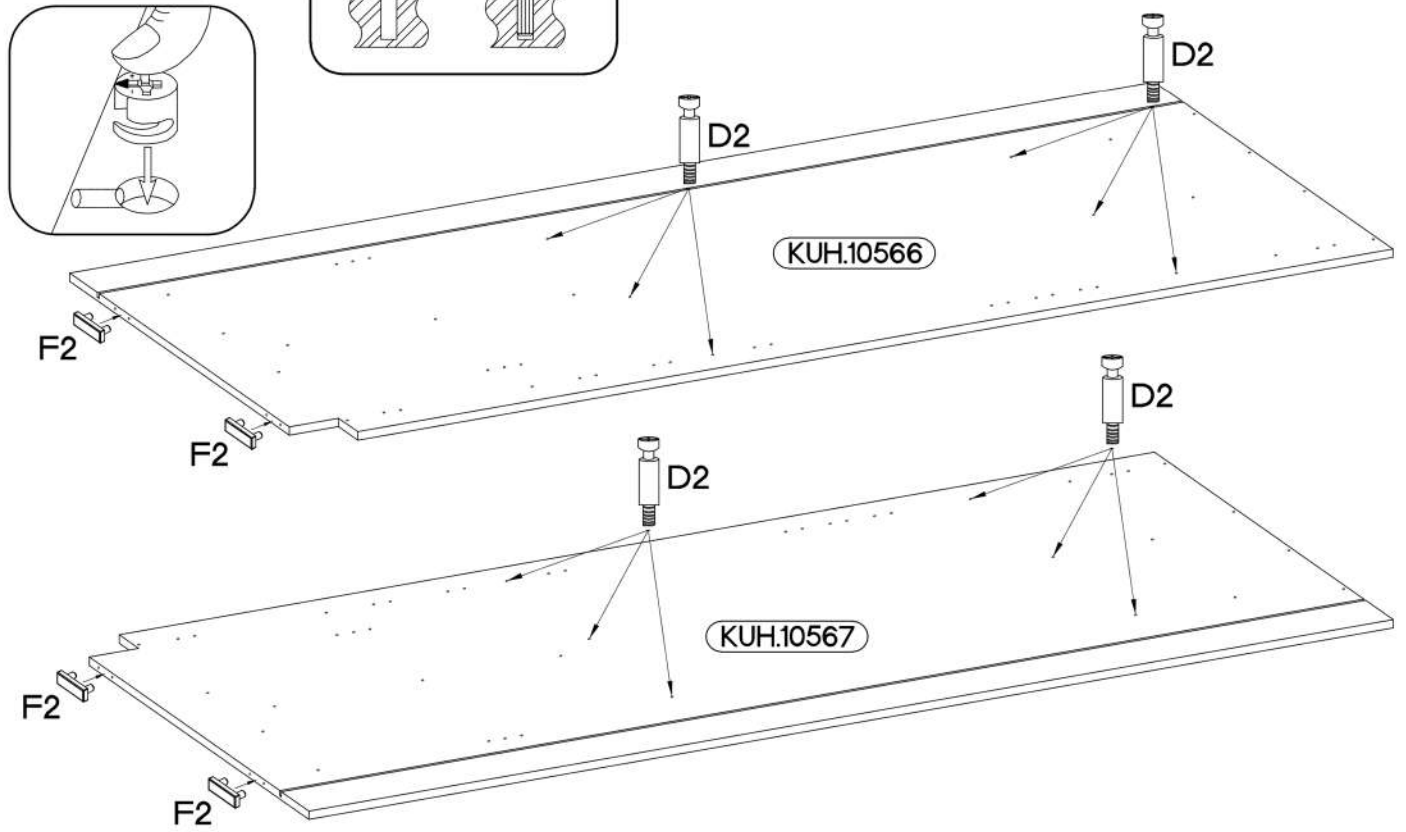
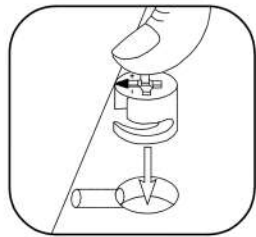
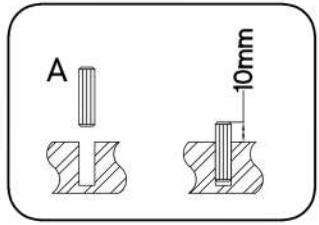
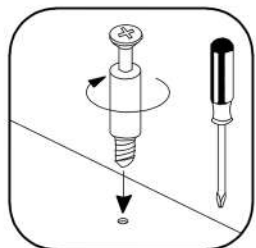
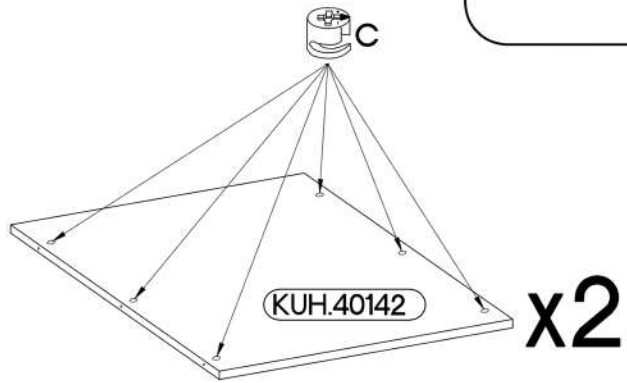
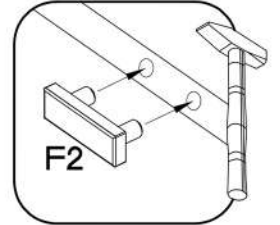
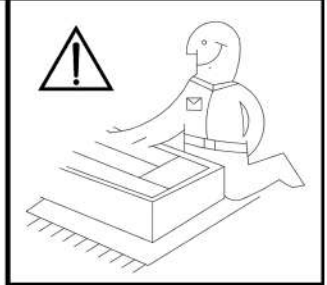

# 11

6,4 x 50mm



B

4



O

1



E1

4

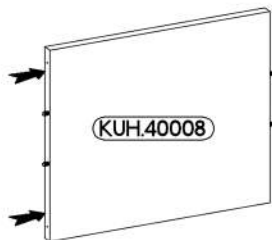
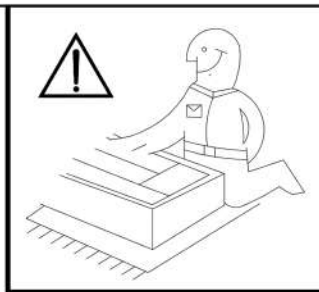

KUH.40008

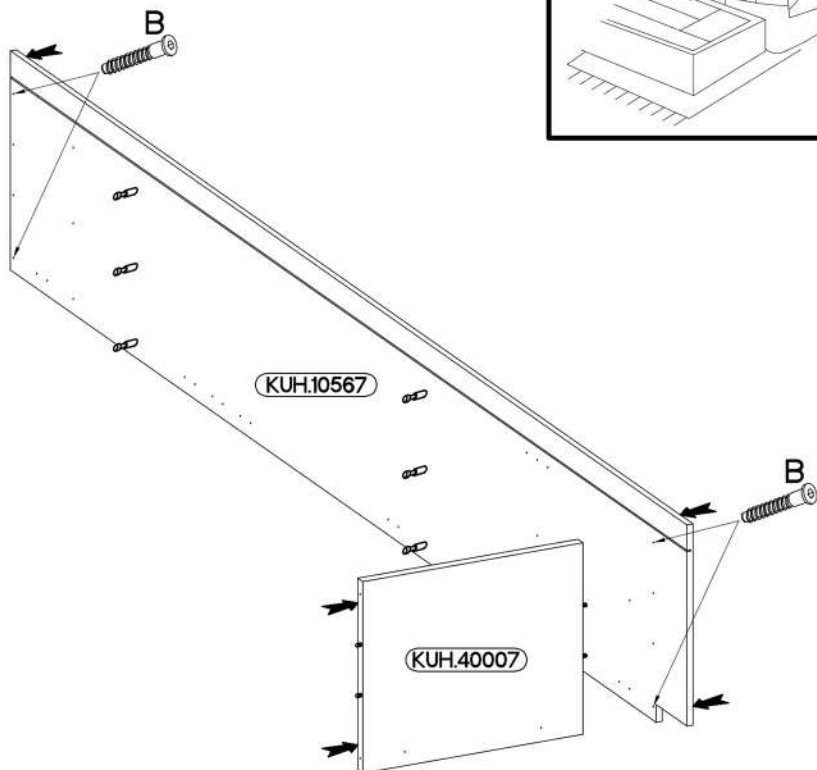

KUH.10567

KUH.40007

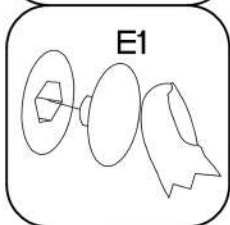

# 12

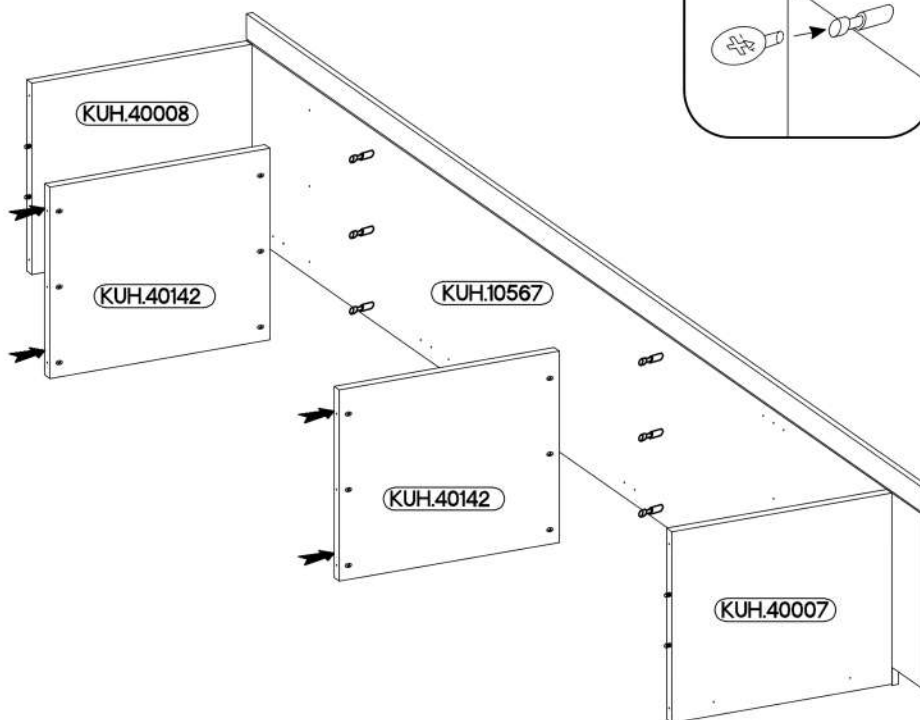

KUH.40008

KUH.40142

KUH.10567



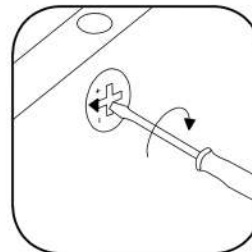
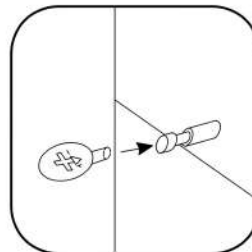

KUH.40142

KUH.40007





# 13

6,4 x 50mm

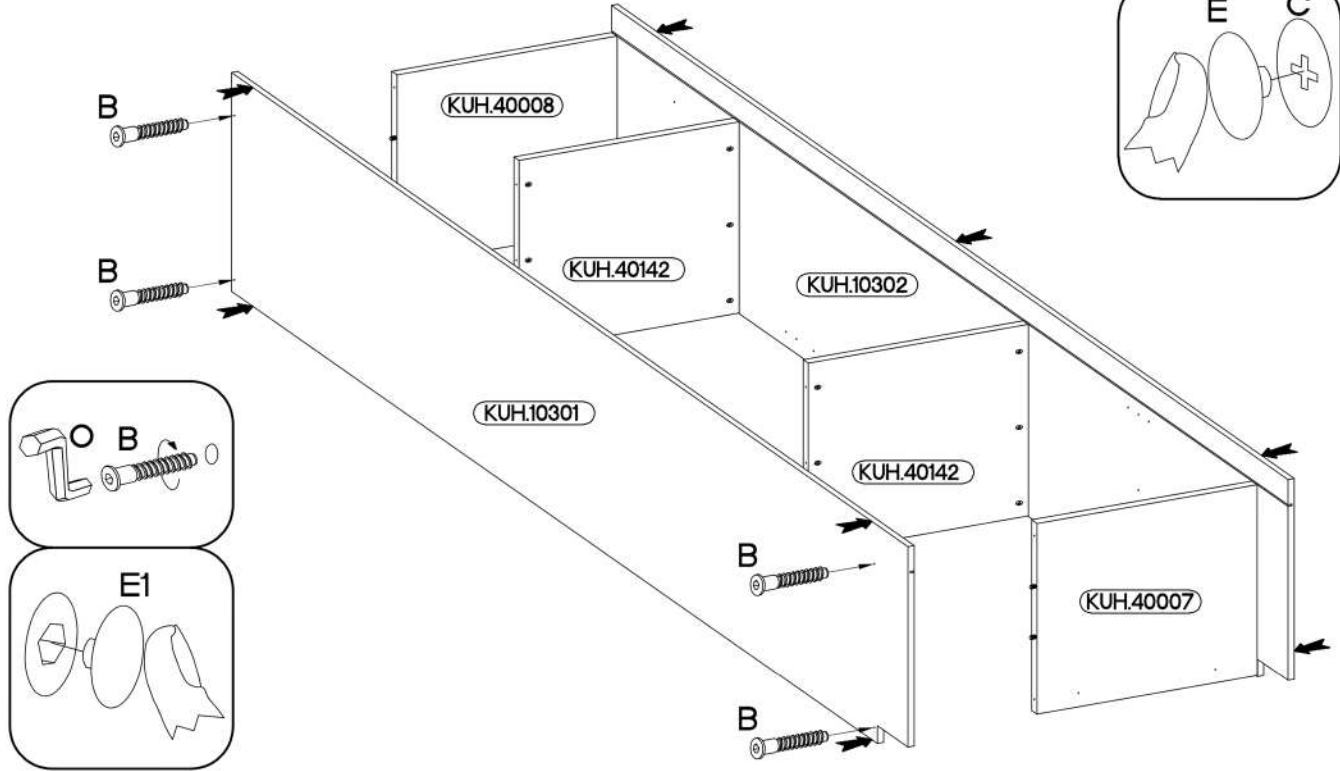
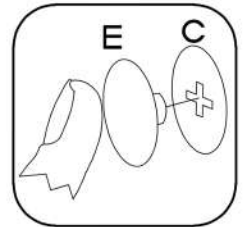
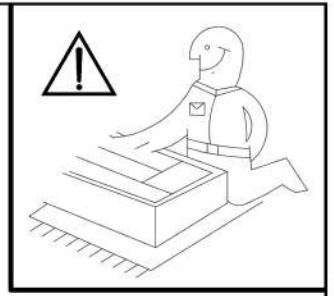
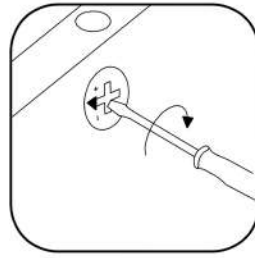
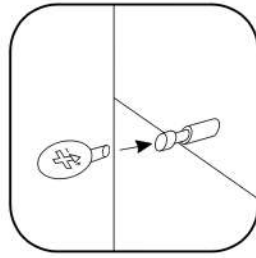
			
B	O	E1	E
4	1	4	12



# 14

	
T4	P1
4	16

4.0x16mm

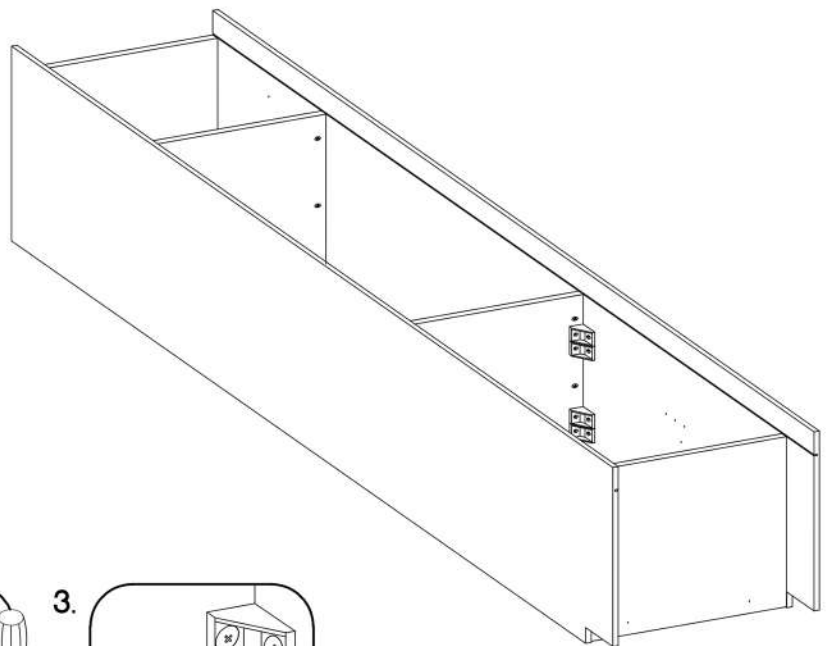
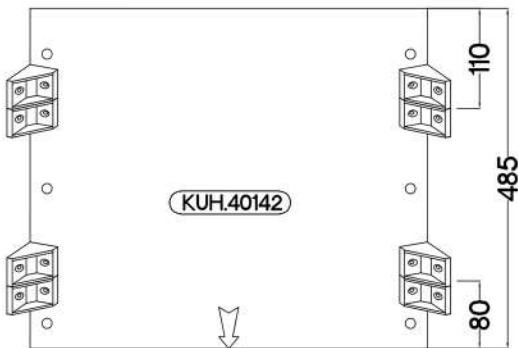

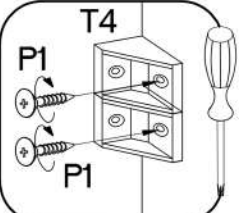
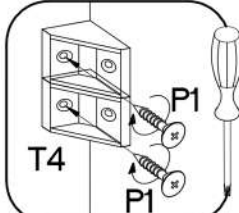
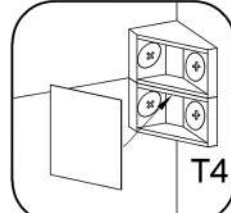
- 
- 
- 

15

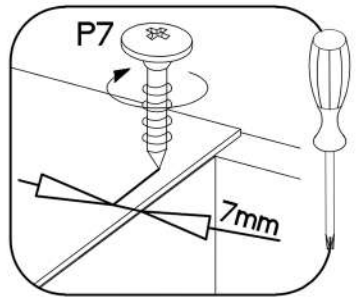
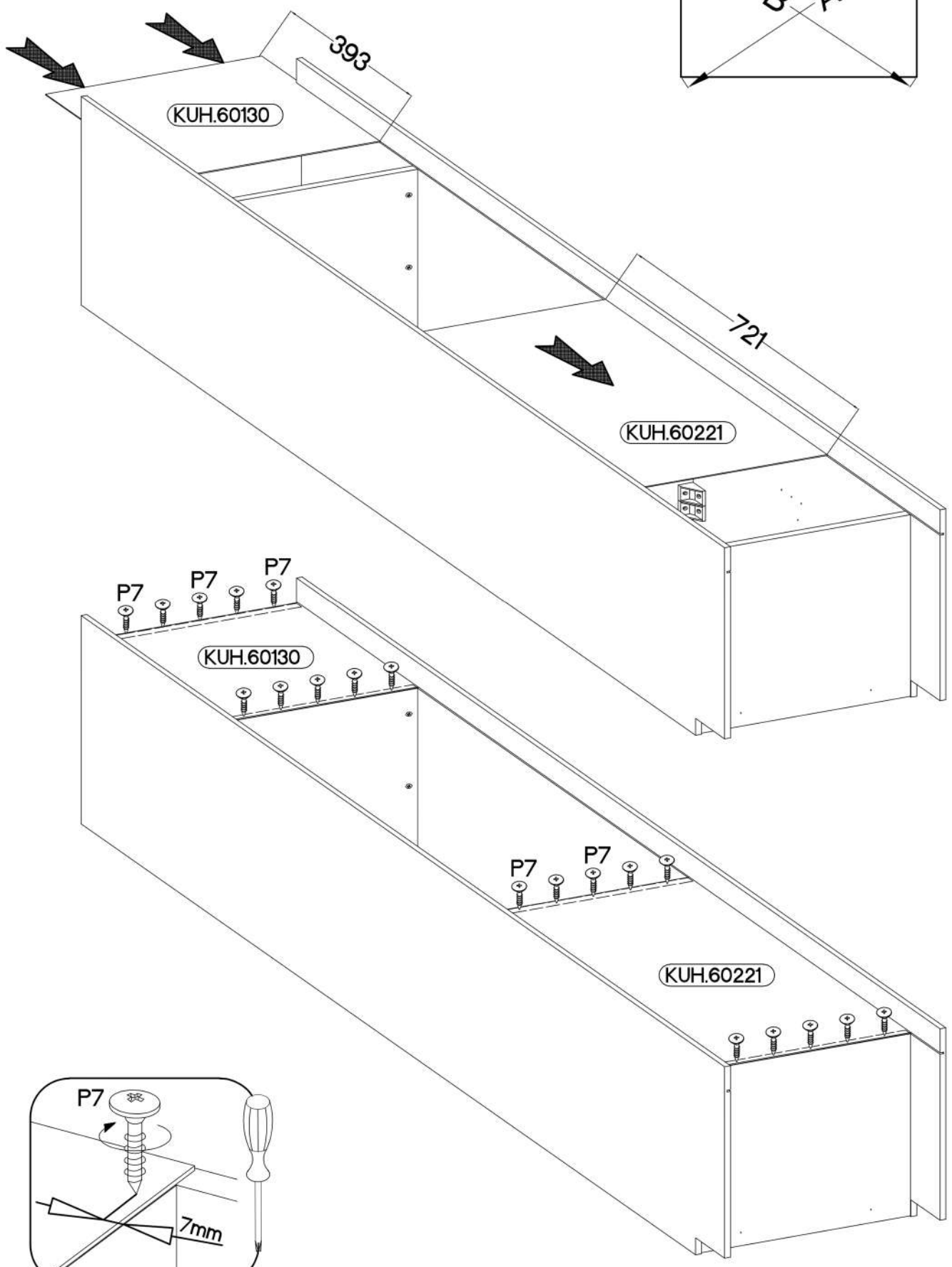
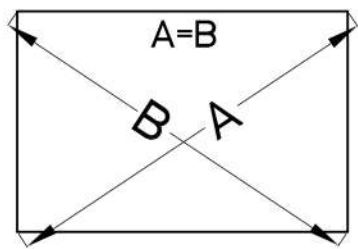

3.0x20mm  
P7  
15-20

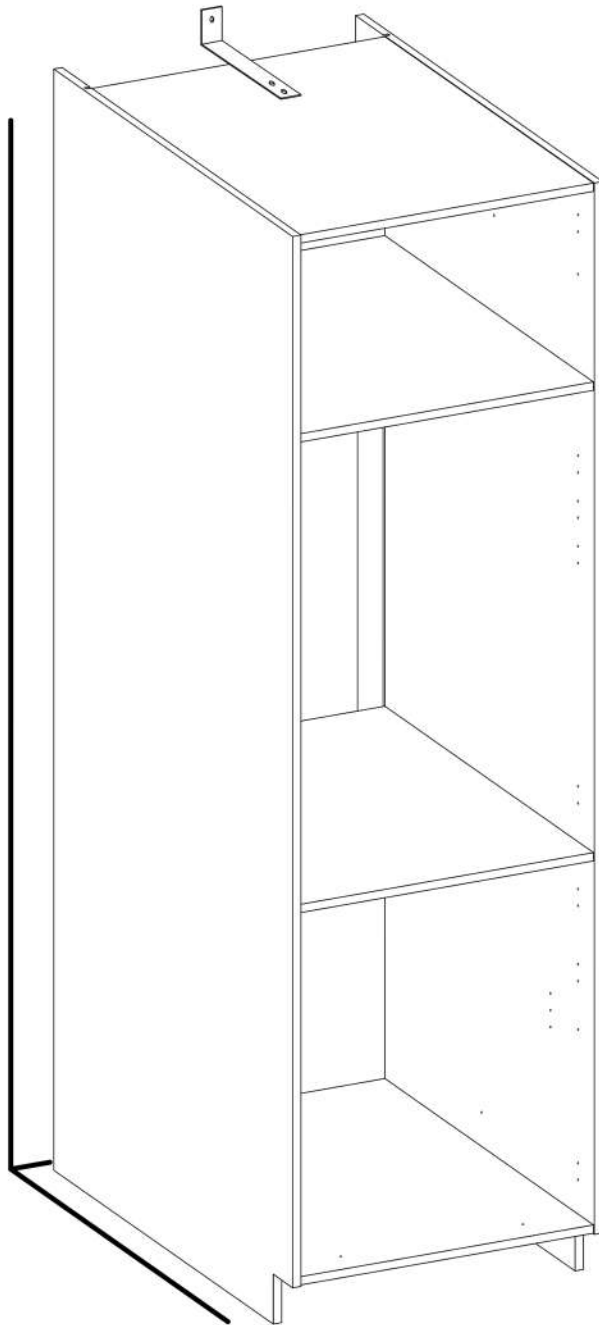
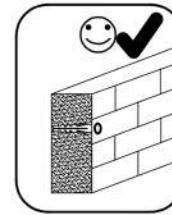
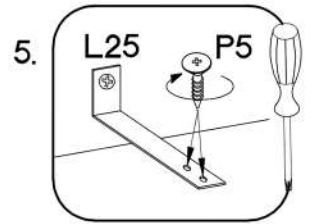
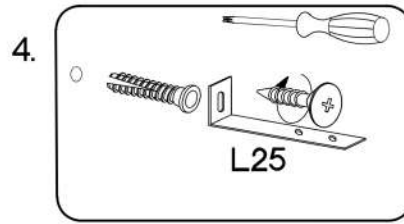
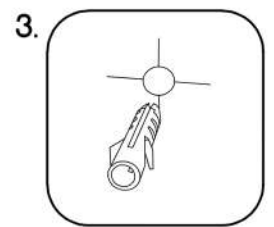
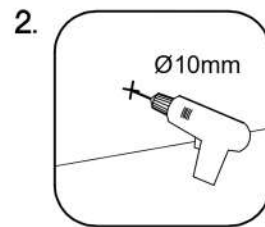
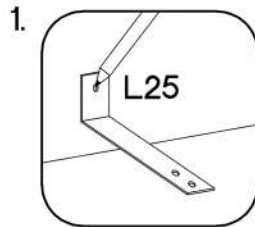
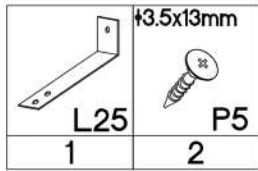

16



17

+4.0x45mm		
P4	E9	
2	2	

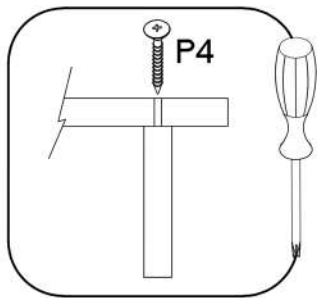
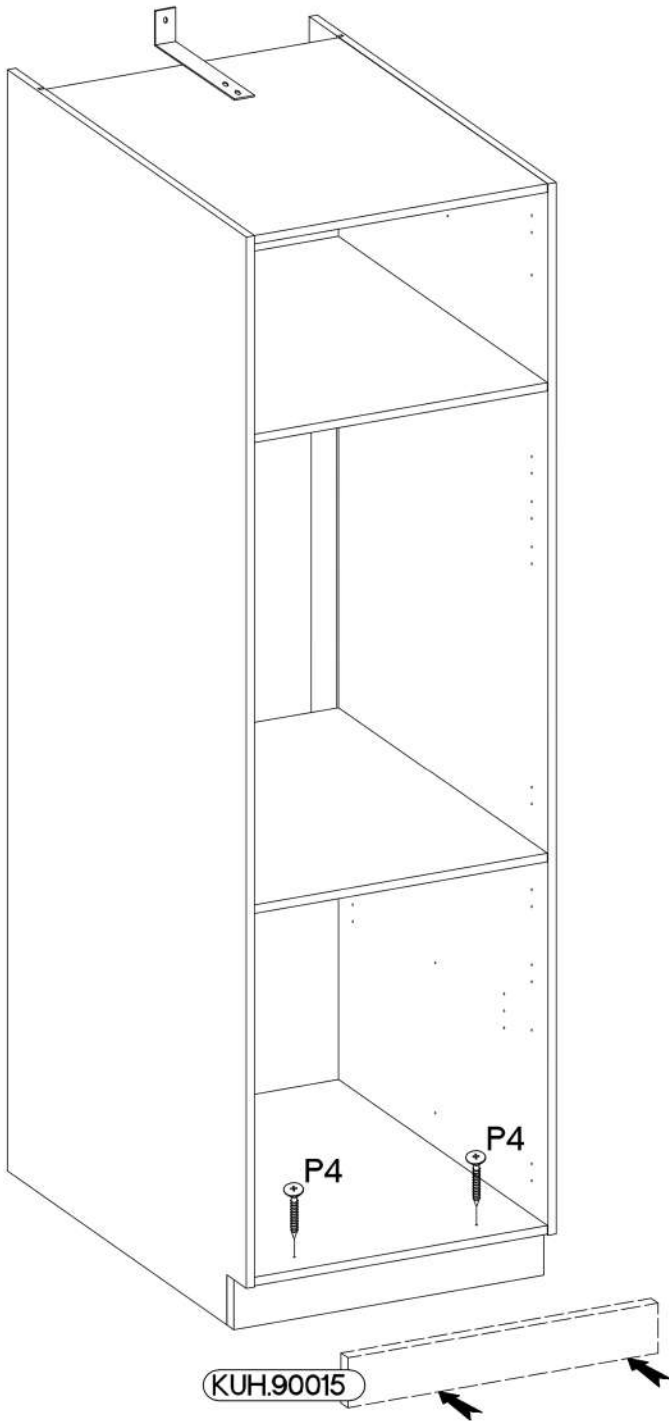

18

+5/19mm	
J	
4	

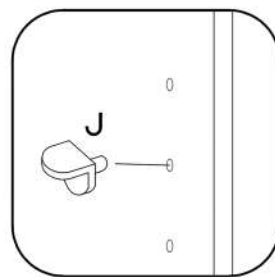
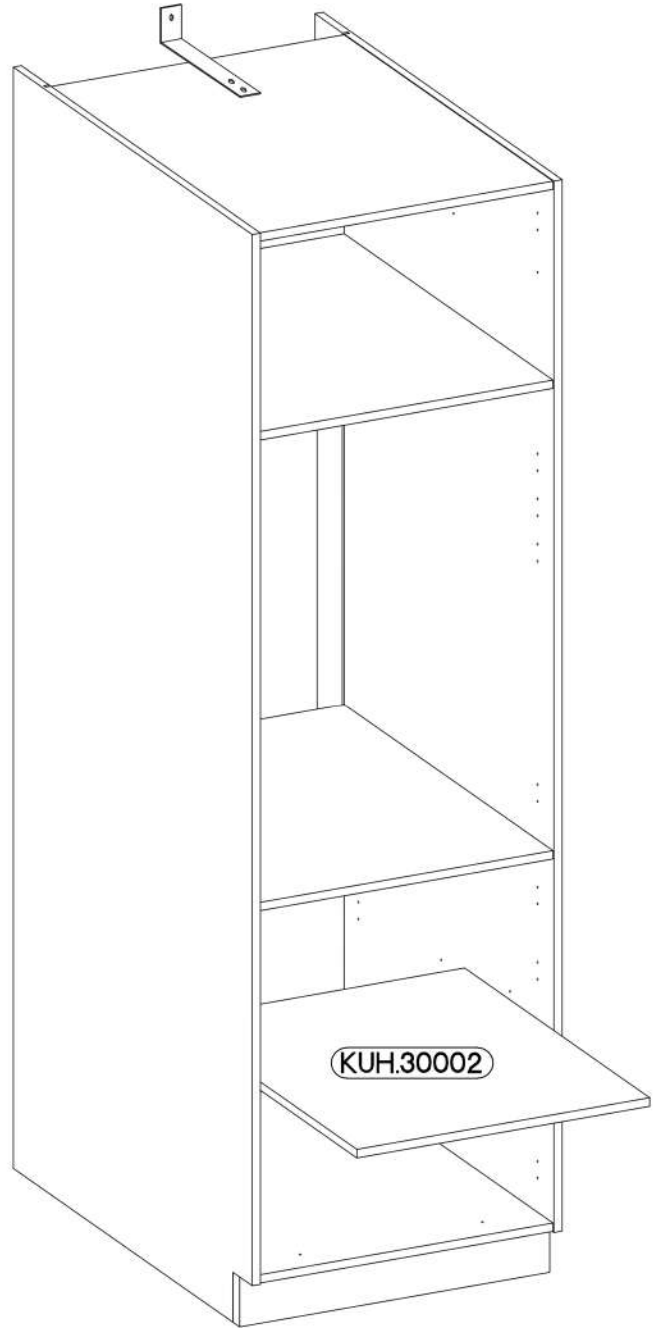

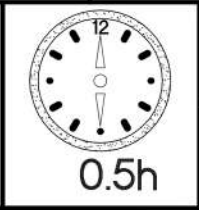
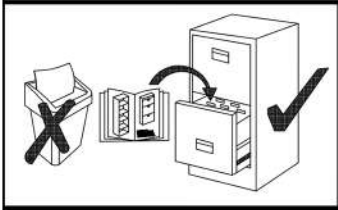
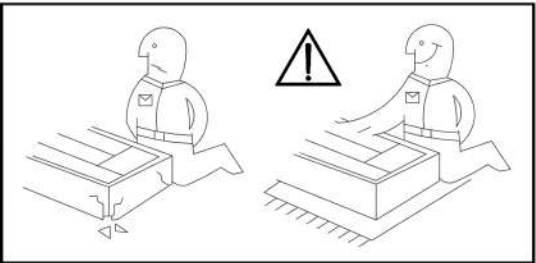
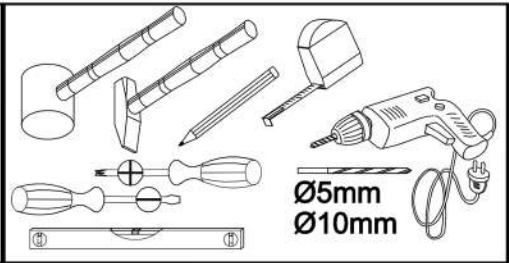
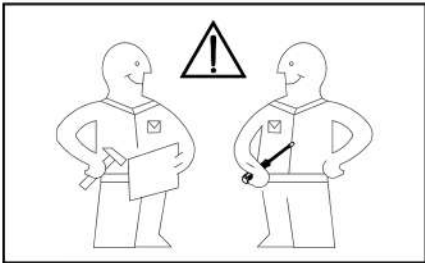

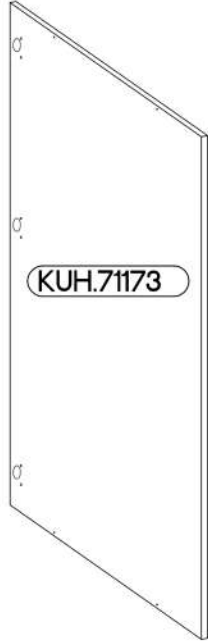
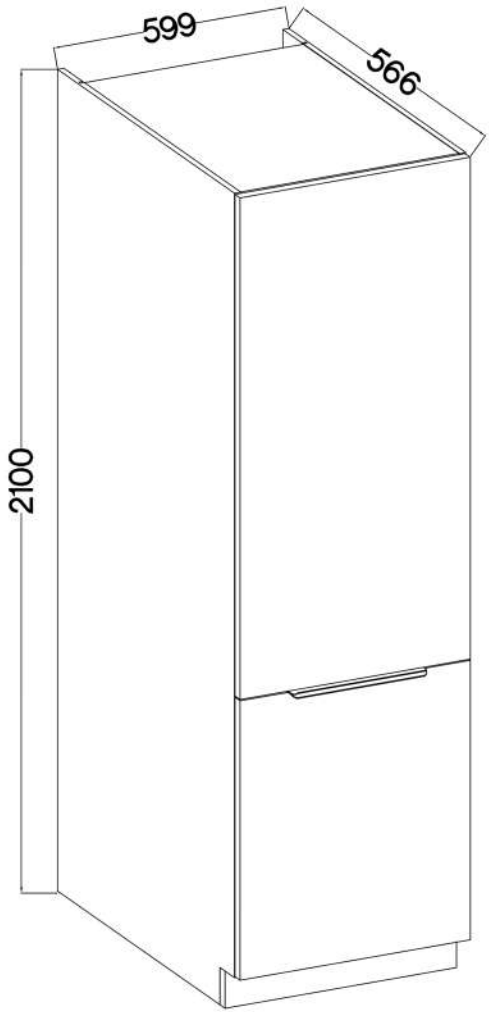
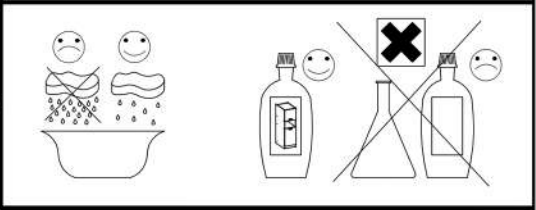

**60 LO-210-2F**



L=320mm	±7/2mm
S	J5
2	4

KUH.71173	1280x596x16
KUH.71151	713x596x16

# 1

$\pm 35/0\text{mm}$  [CD] HG 5	$\pm 3.5 \times 13\text{mm}$  P5 10	$\pm 7/2\text{mm}$  J5 4
--	---	--

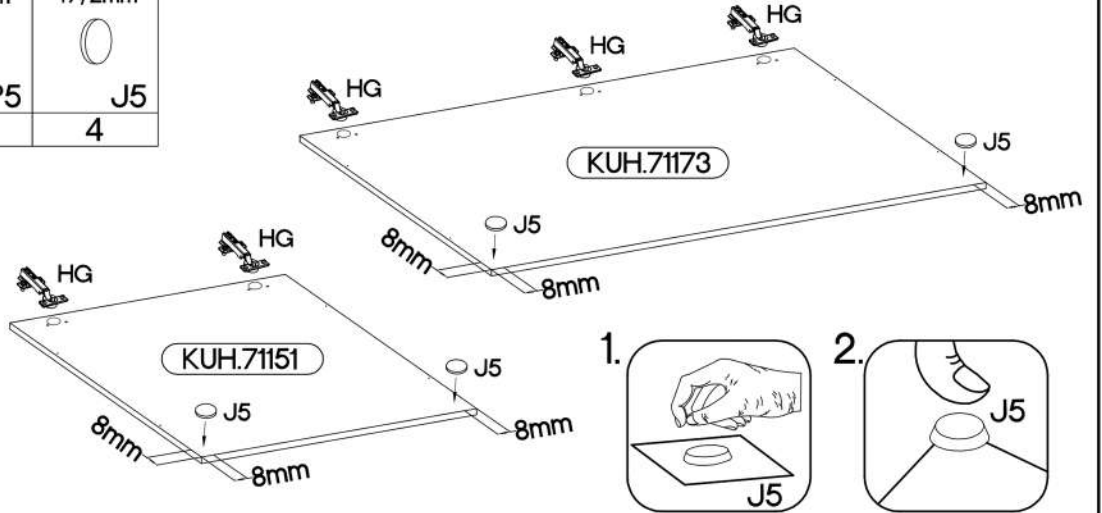
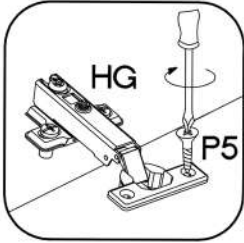

# 2

## 60 DK-2100 2F

$L=320\text{mm}$  S 2
---

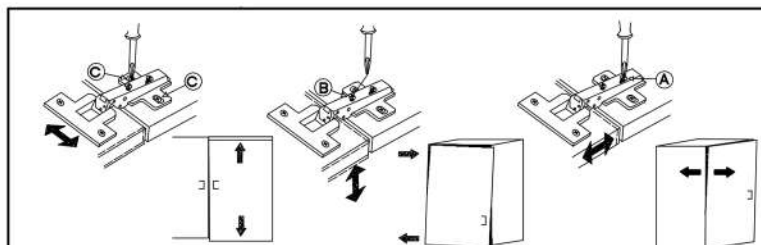
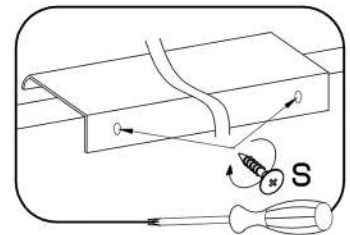
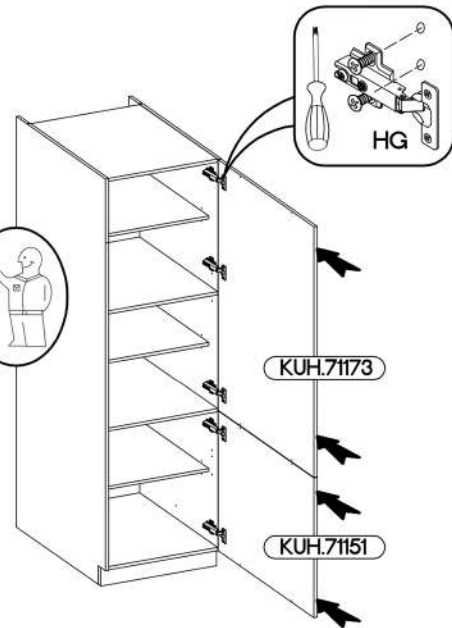
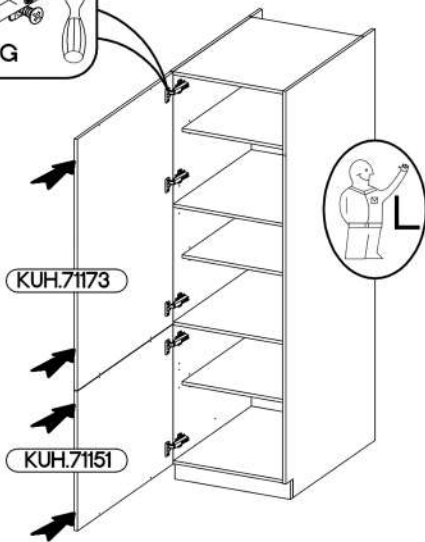

# 3

# 60 LO-2100

L=320mm

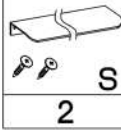

## WARIANT A

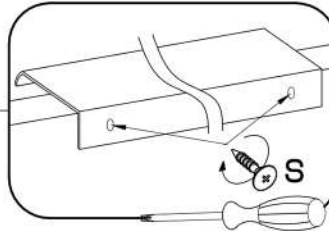
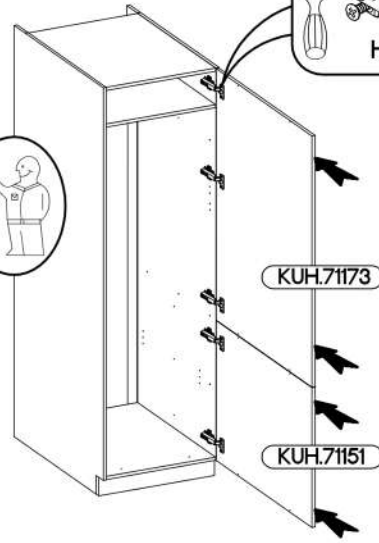
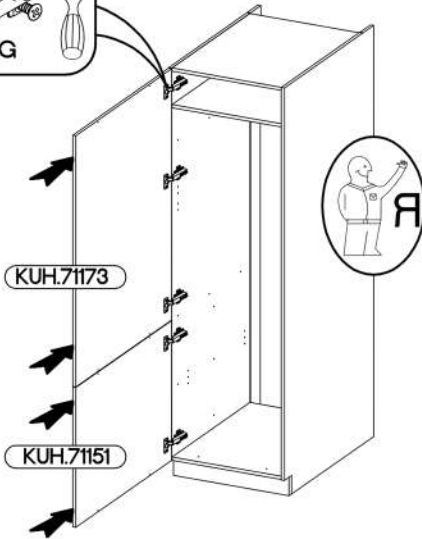

## WARIANT B

