

Ø10mm

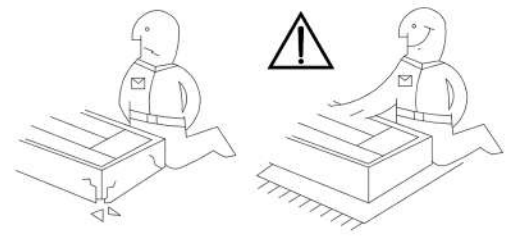

# FRISBO 60 DK-210 2F

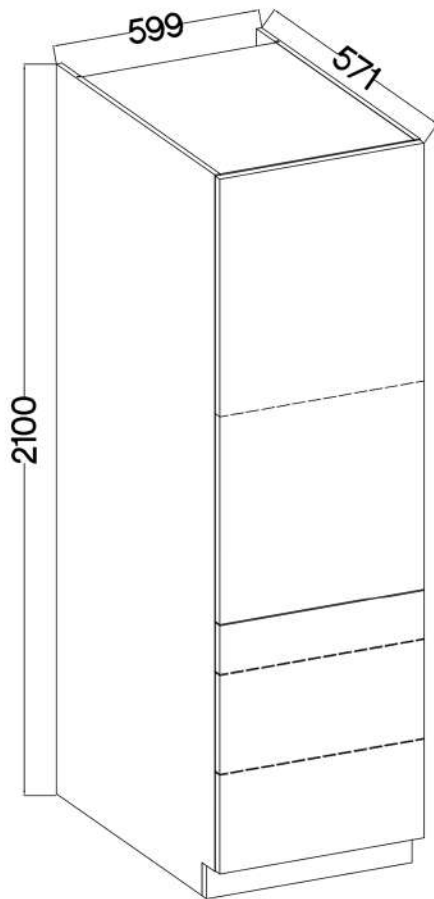

max. 10kg  
 KUH.30002  
 KUH.40007  
 KUH.40008

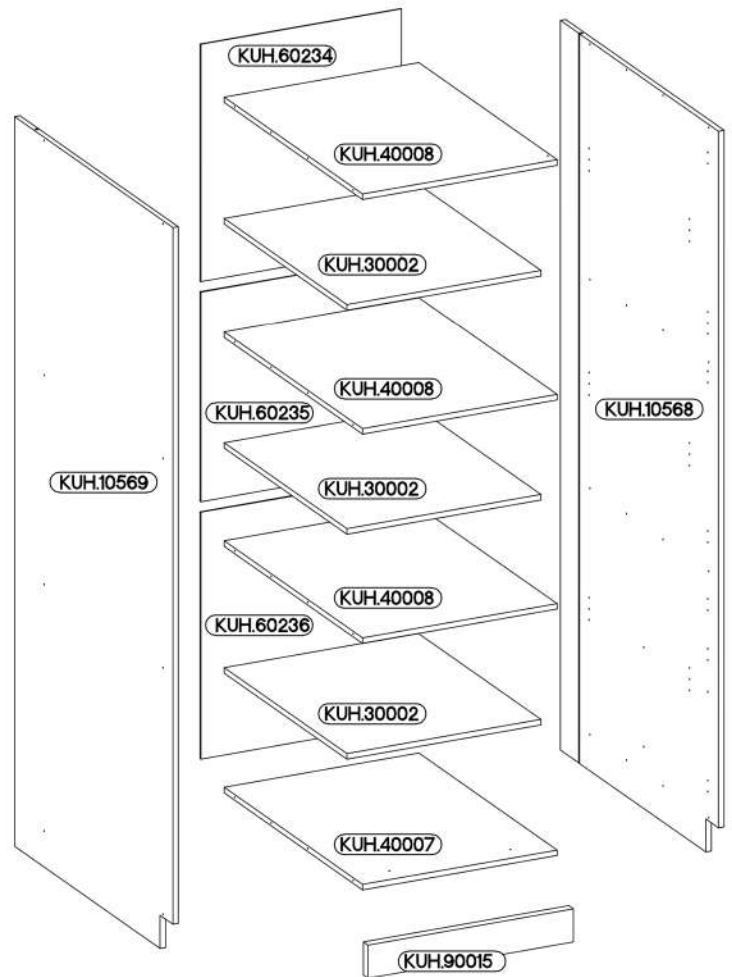



KUH.10568	2095x555x16
KUH.10569	2095x555x16
KUH.30002 x3	566x430x16
KUH.40007	567x485x16
KUH.40008 x3	567x485x16
KUH.60234	681x585x2,5
KUH.60235	603x585x2,5
KUH.60236	708x585x2,5
KUH.90015	599x95x16

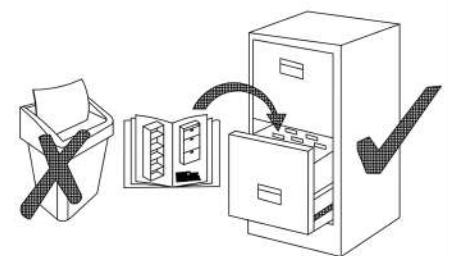

±8x30mm A 16	6,4 x 50mm B 16	E1 16	E9 2	6.5x48x16 F2 4	±35/0mm HG 5
±5/19mm J 12	L2 8	L25 1	O 1	±4.0x45mm P4 2	±3.5x13mm P5 12
					±3.0x20mm P7 15-20



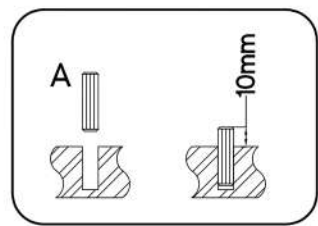
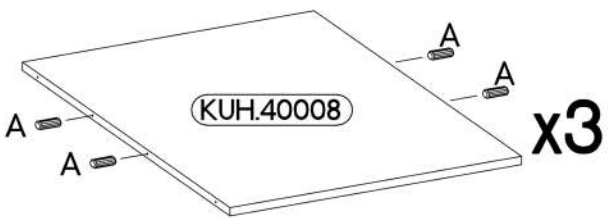
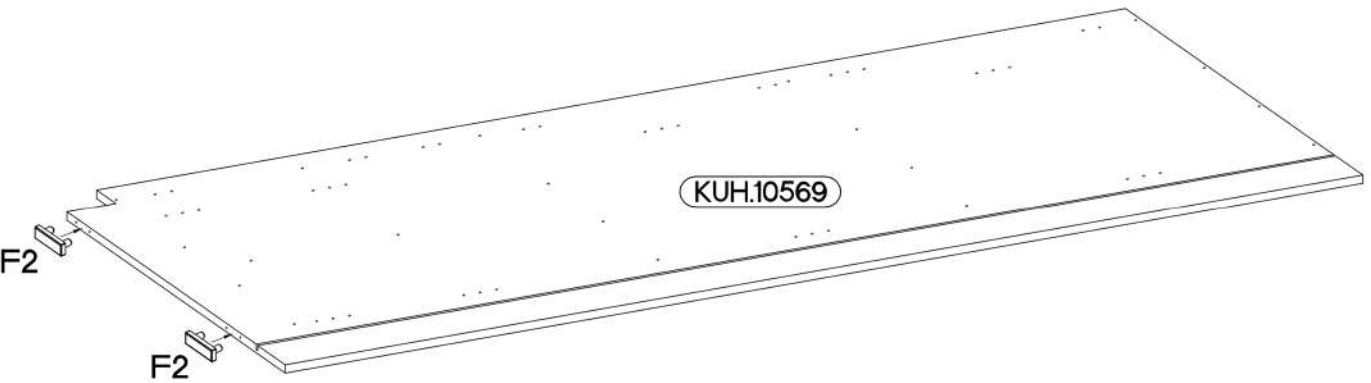
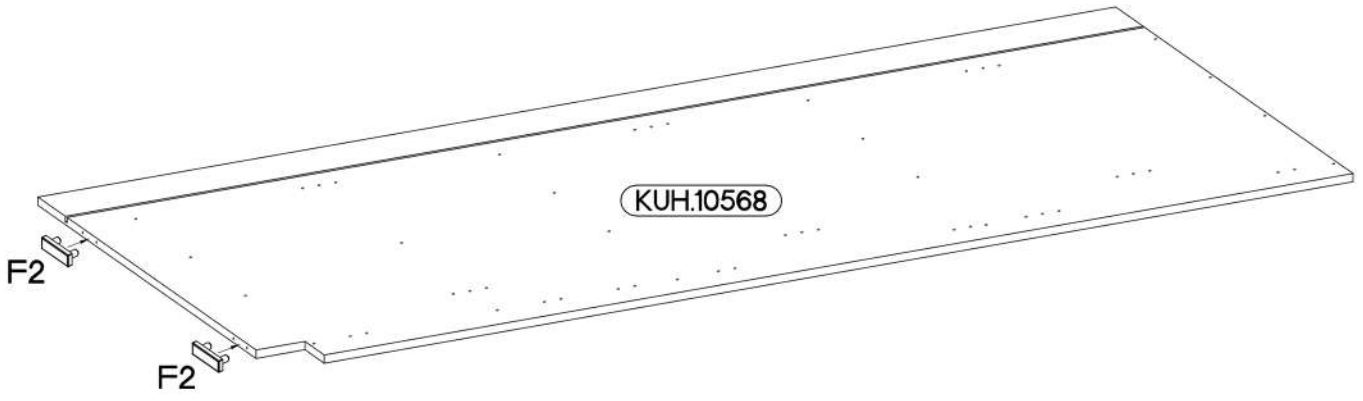
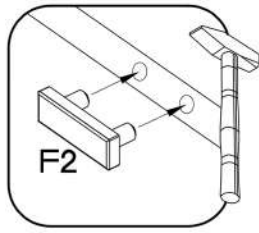

1

6.5x48x16	†8x30mm
	
F2	A
4	16





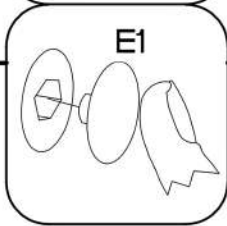
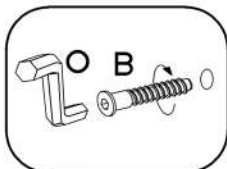
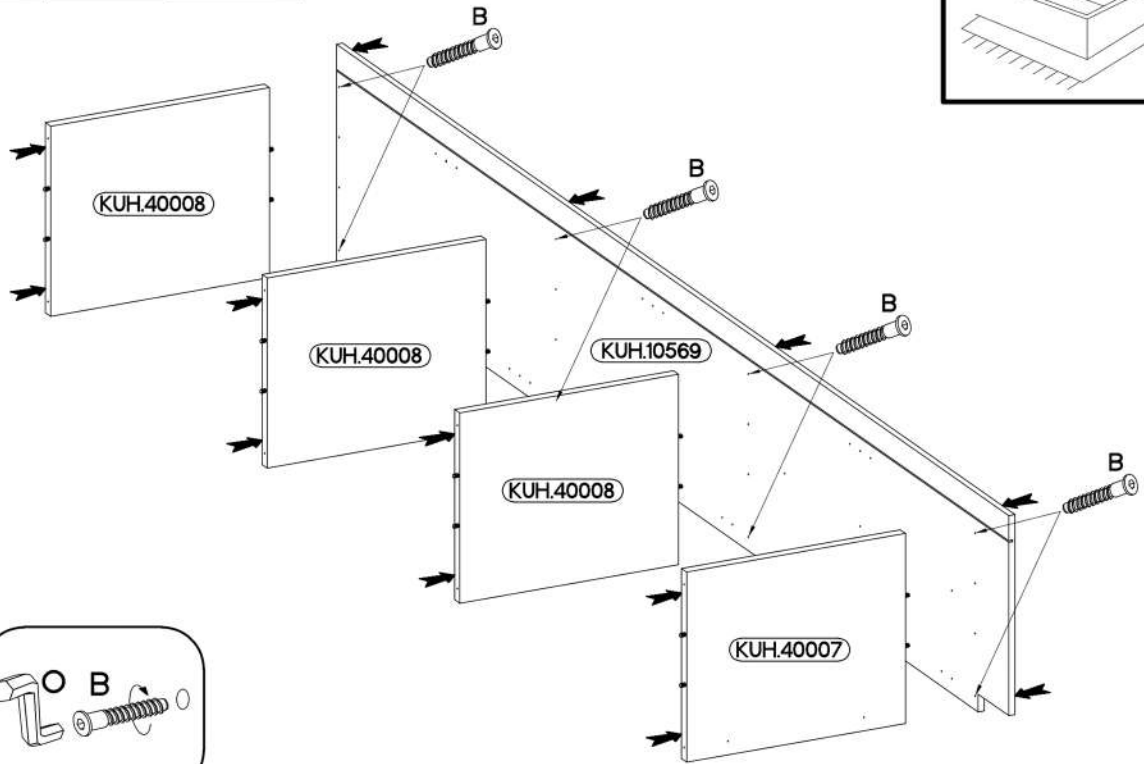

2

6,4 x 50mm		
		
B	O	E1
8	1	8

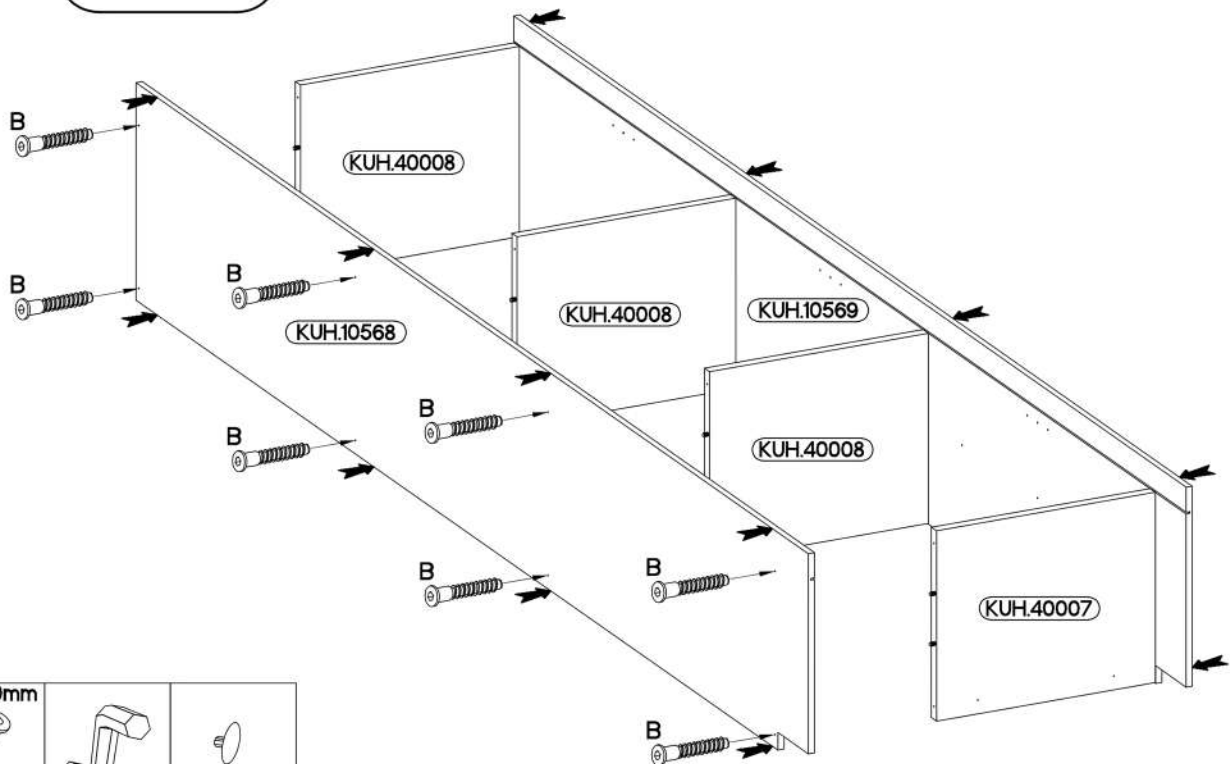

3



6,4 x 50mm		
		
B	O	E1
8	1	8

60 DP-210 2F

60 DPS-210 1F 3S

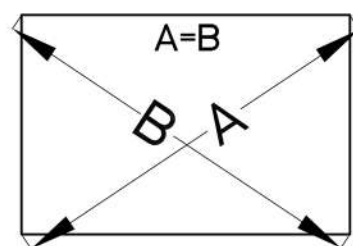
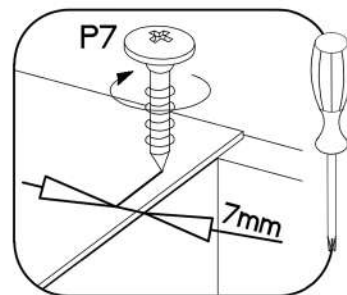
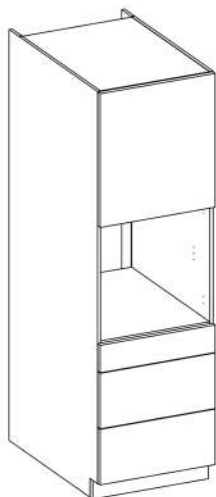
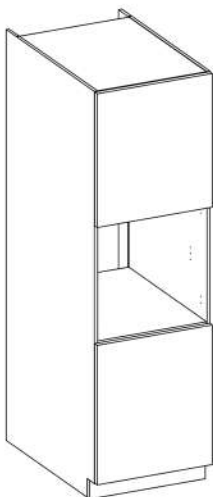

4

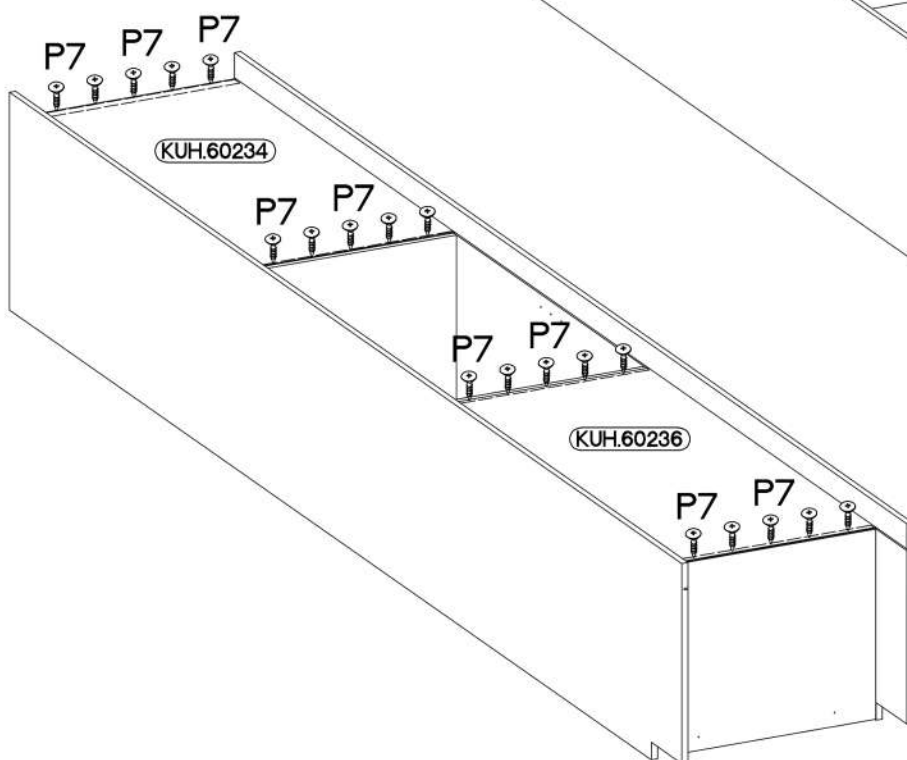
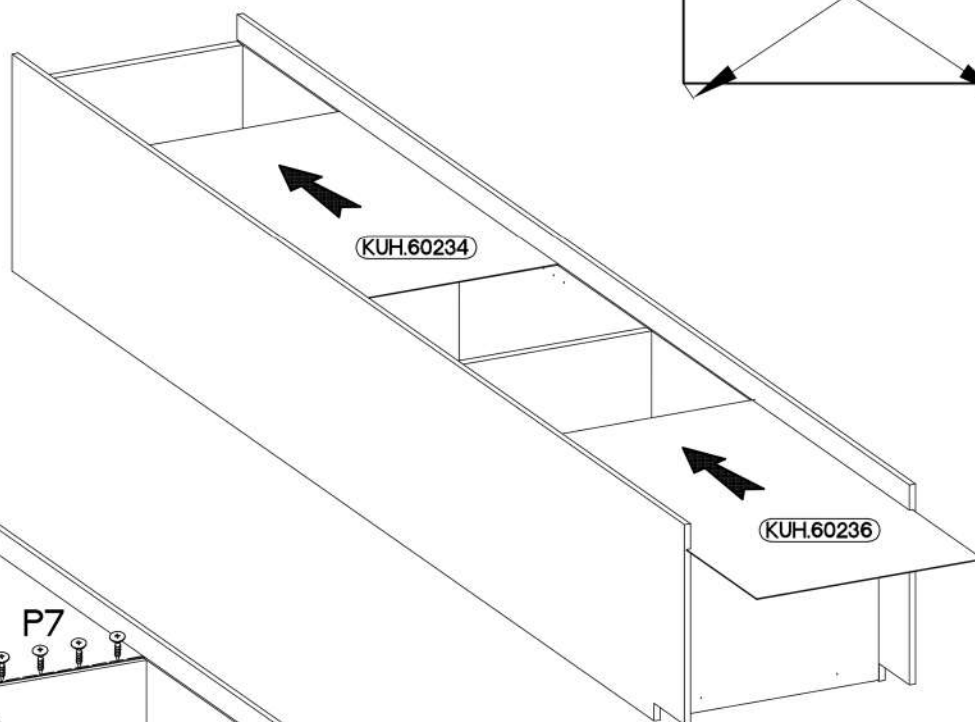
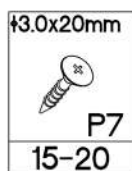

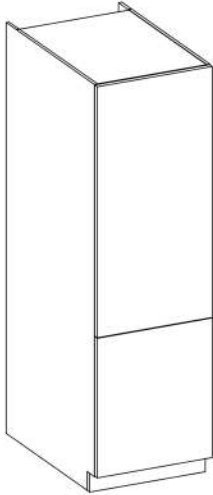

60 DK-210 2F

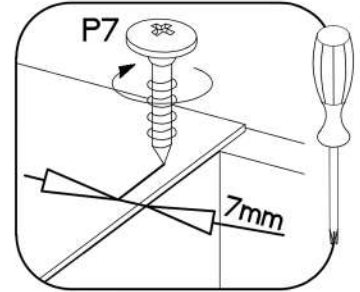
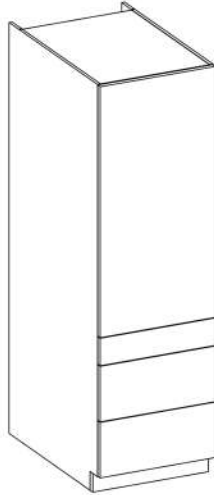

60 DKS-210 1F 3S



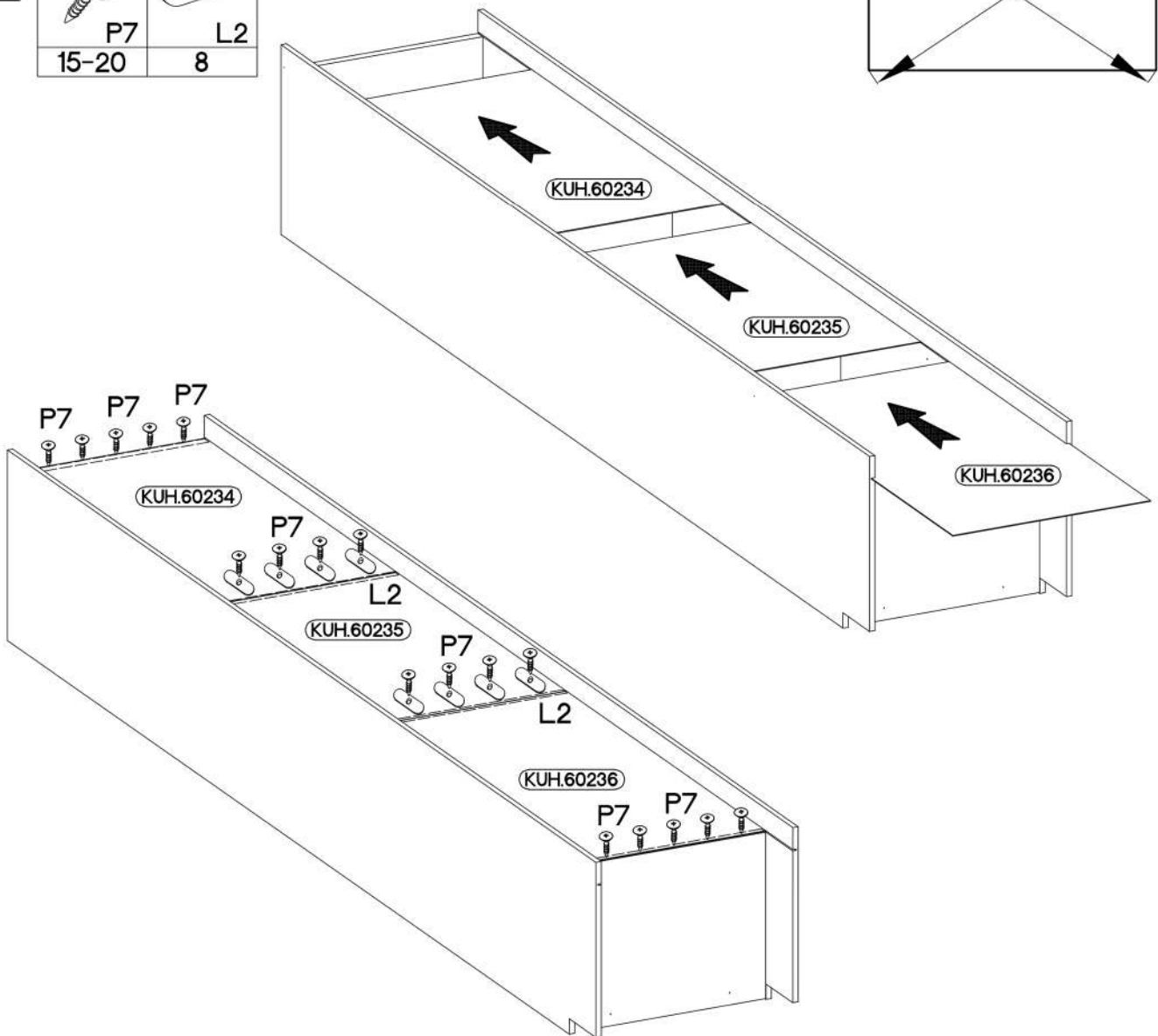
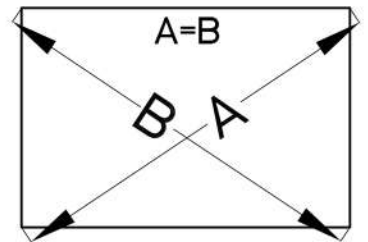

5

+3.0x20mm	
	
P7	L2
15-20	8



6

 †4.0x45mm P4 2	 E9 2
---	--

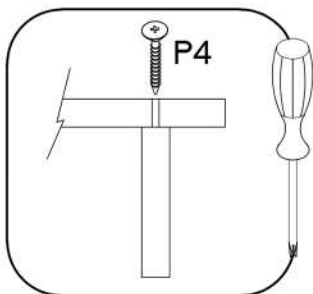
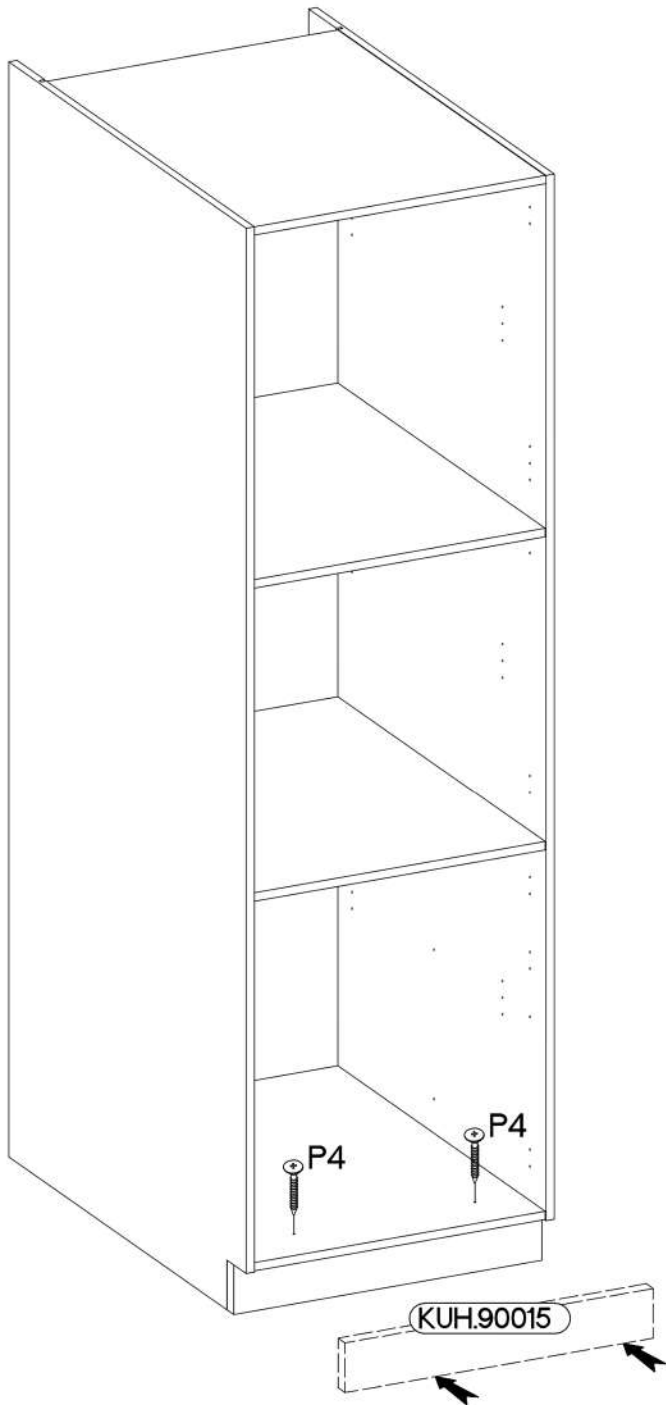

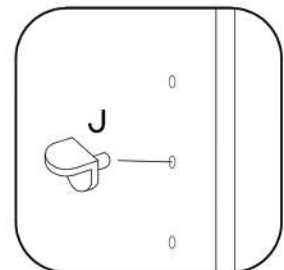
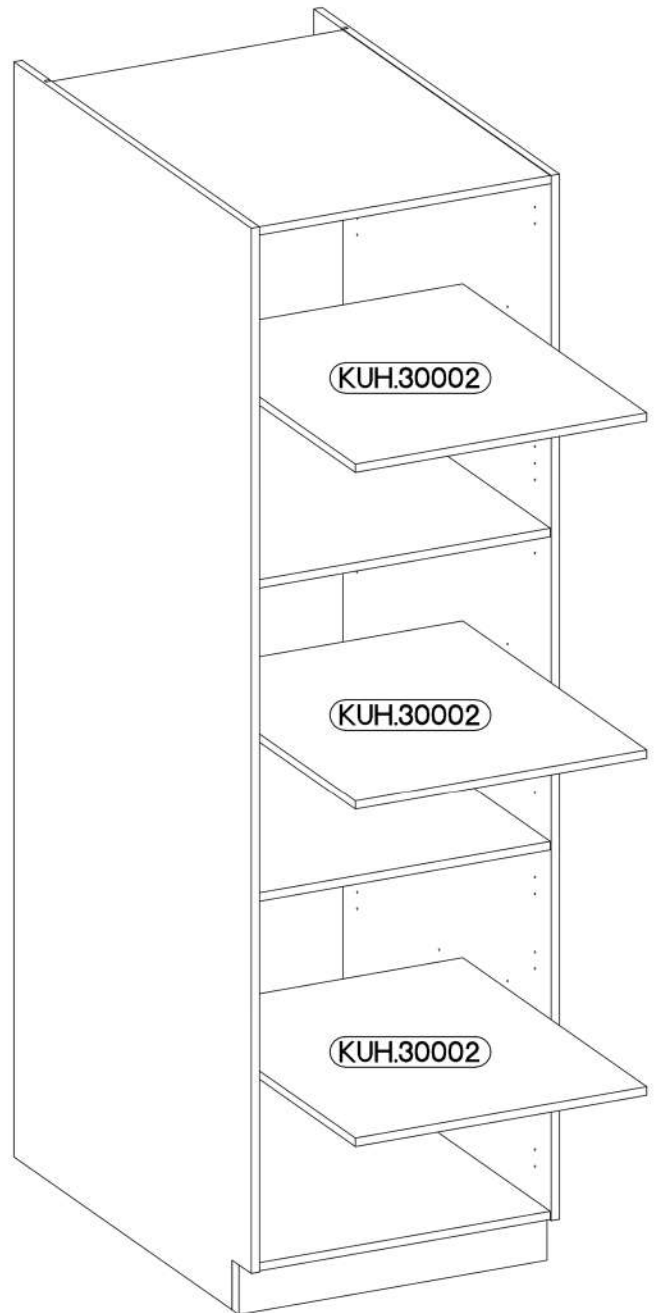

7

 †5/19mm J 12
--

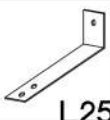

8

 L25 1	 #3.5x13mm P5 2
---	---

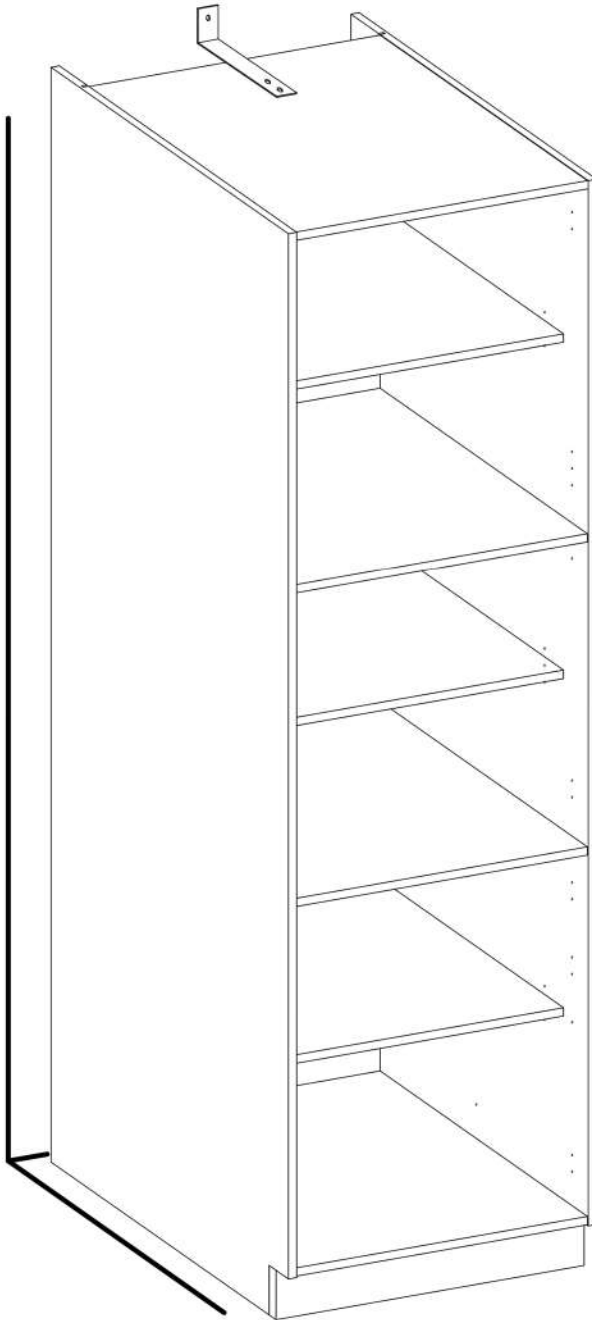
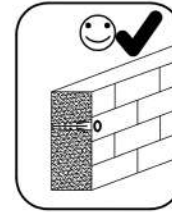
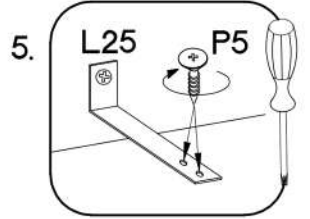
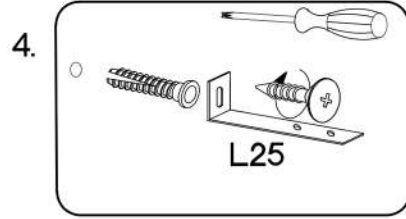
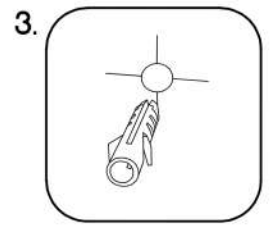
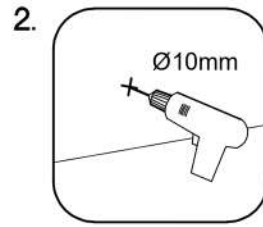
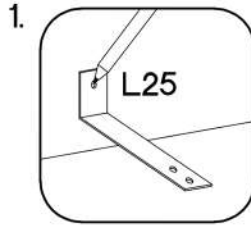

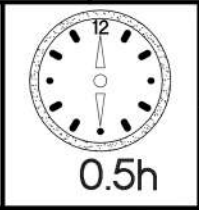
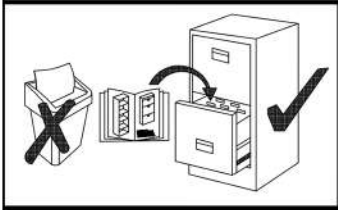
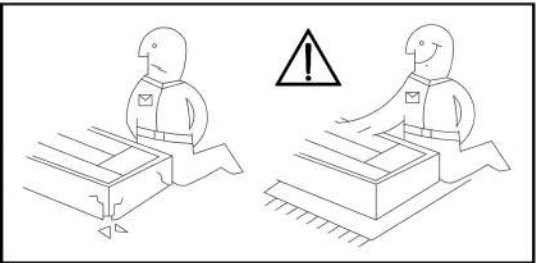
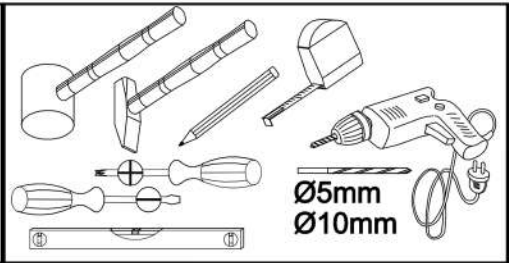
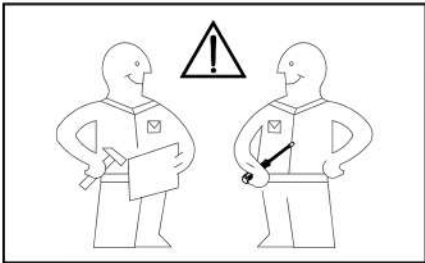

60 DK-210-2F

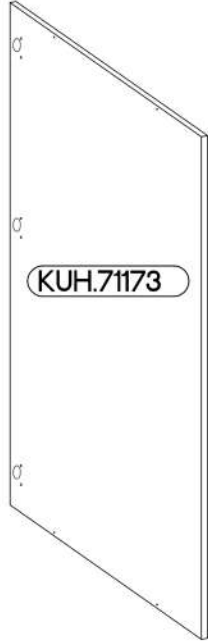
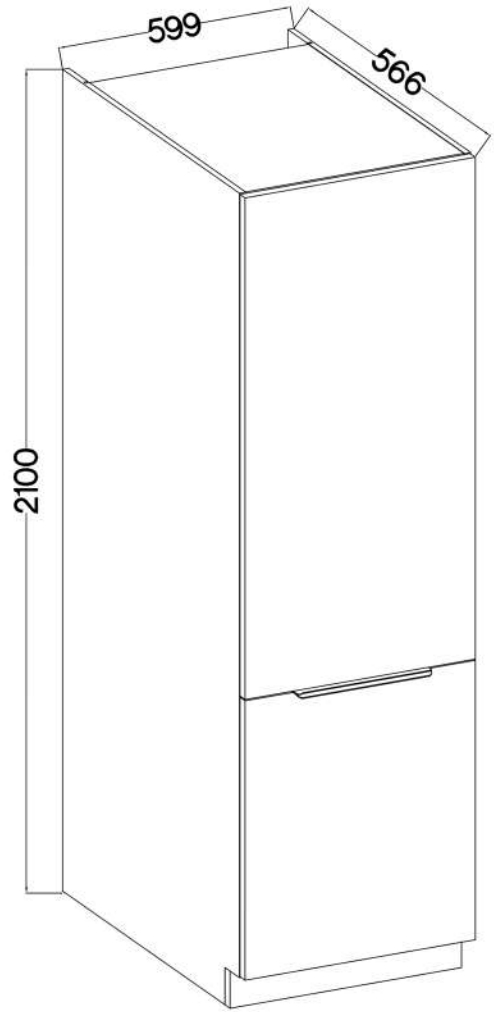
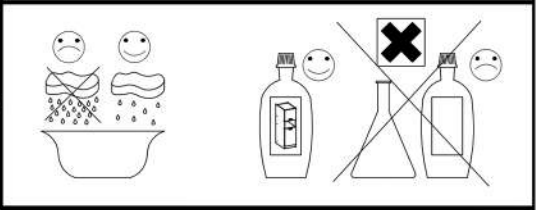

L=320mm	±7/2mm
S	J5
2	4

KUH.71173	1280x596x16
KUH.71151	713x596x16

# 1

$\varnothing 35/0\text{mm}$ [CD] HG 5	$\varnothing 3.5 \times 13\text{mm}$ P5 10	$\varnothing 7/2\text{mm}$ J5 4
--	--	---------------------------------------

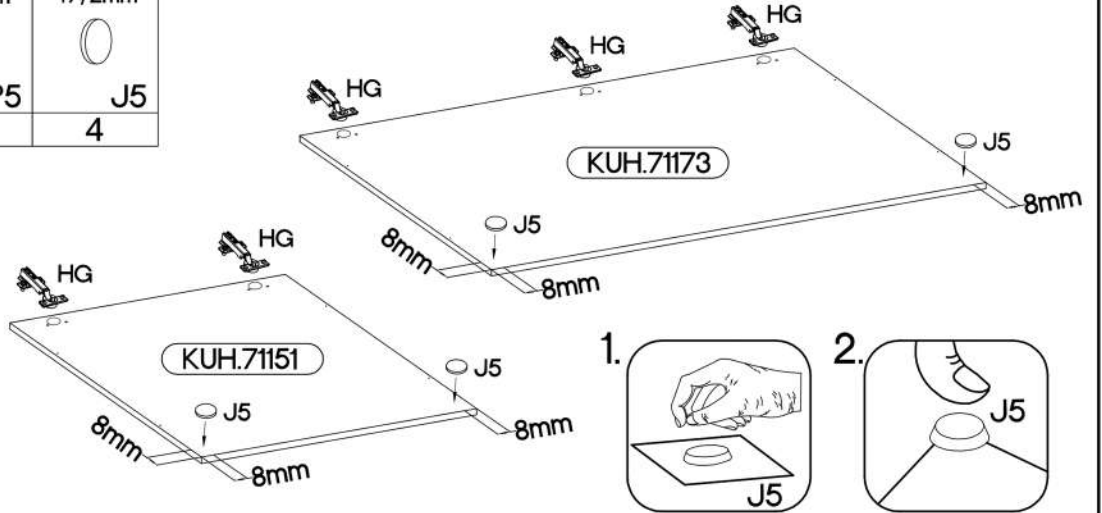
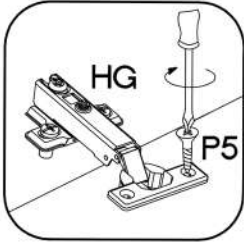

# 2

## 60 DK-2100 2F

L=320mm
S
2

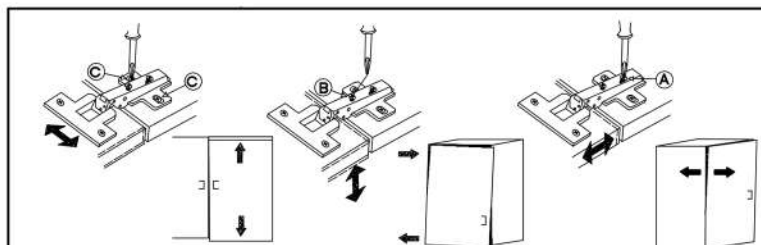
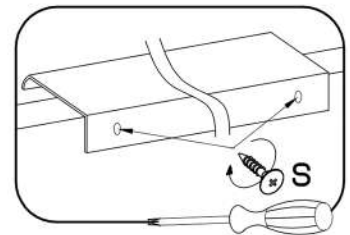
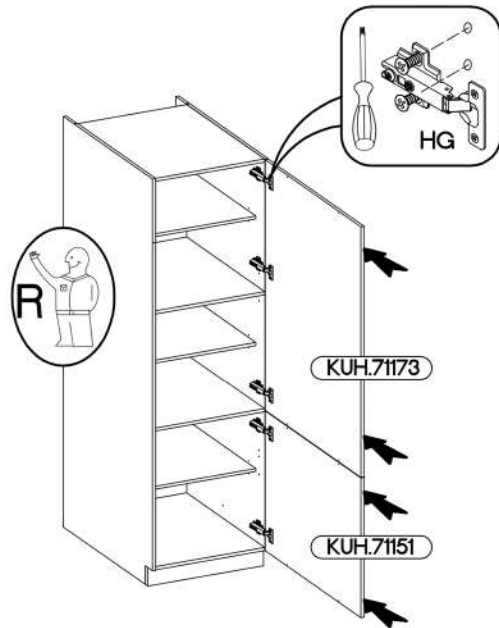
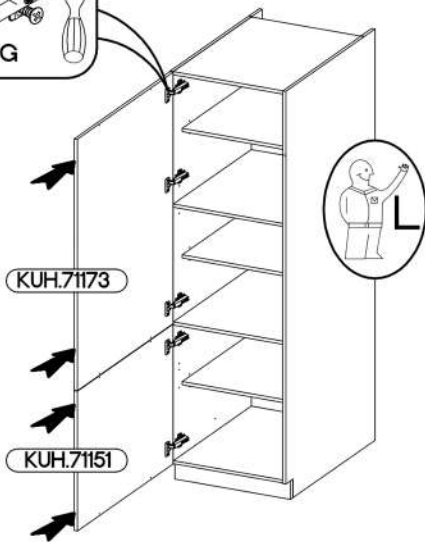

3

60 LO-2100

L=320mm

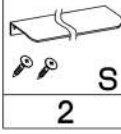

WARIANT A

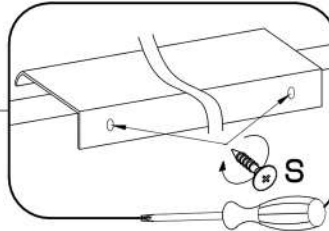
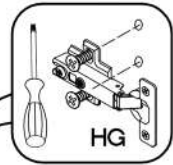
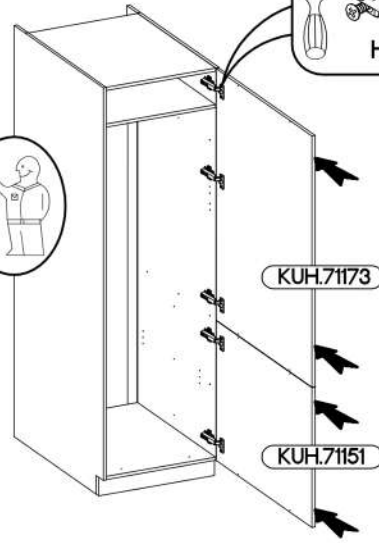
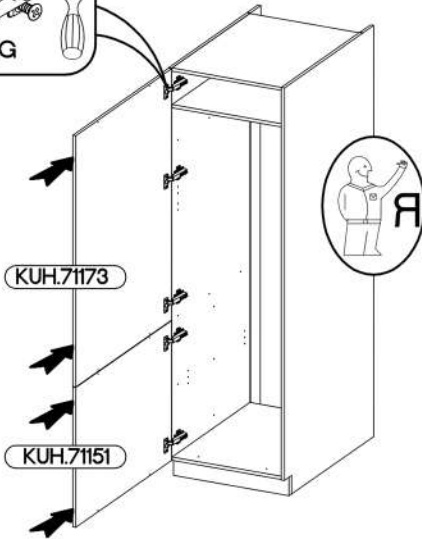
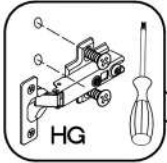

WARIANT B

