

FRISBO 30 G-108 1F

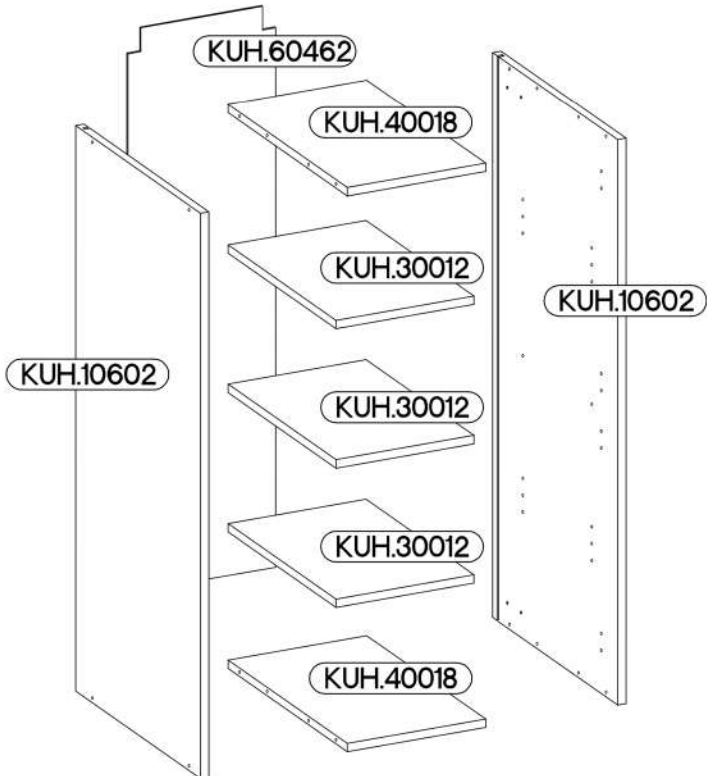

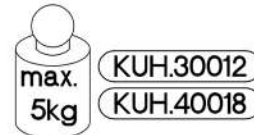
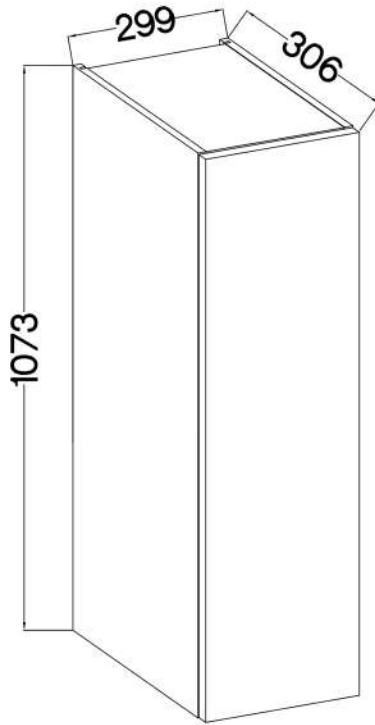
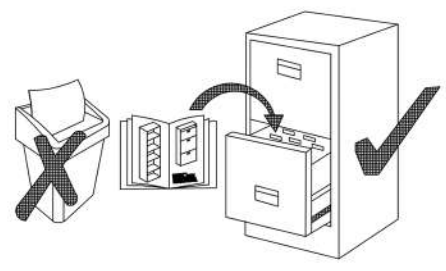

KUH.10602 x2	1073x290x16
KUH.30012 x3	266x250x16
KUH.40018 x2	267x276x16
KUH.60462	1070x285x2,5

 +8x30mm A 8	 6,4 x 50mm B 8	 E1 8	 +35/0mm HG 3	 +3.5x13mm P5 6	 +3.0x20mm P7 8-10	 +4.0x30mm P8 4
 +5/16mm J3 12	 K 2	 O 1				



1

$\pm 8 \times 30 \text{mm}$  A	$\pm 4.0 \times 30 \text{mm}$  P8	 K
8	4	2

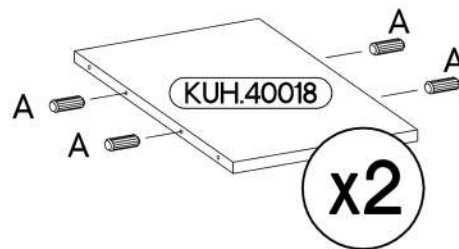
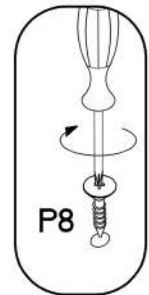
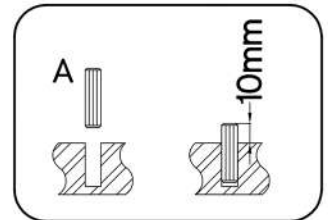
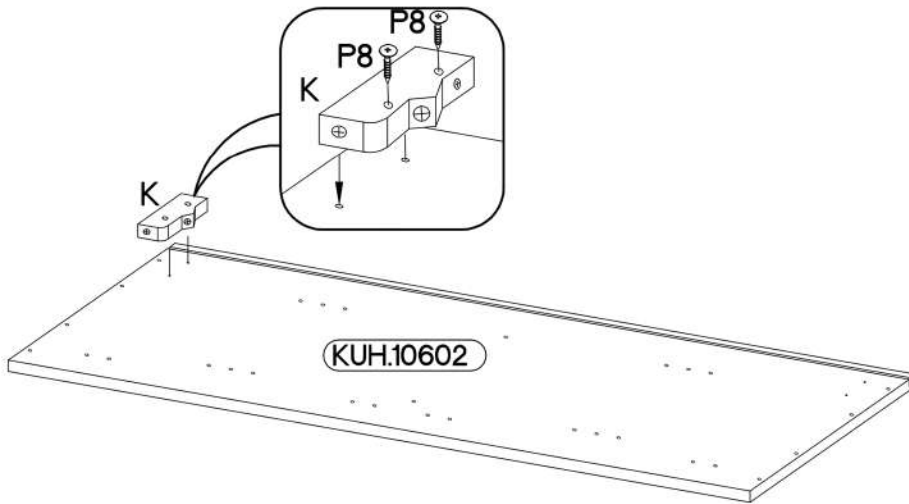
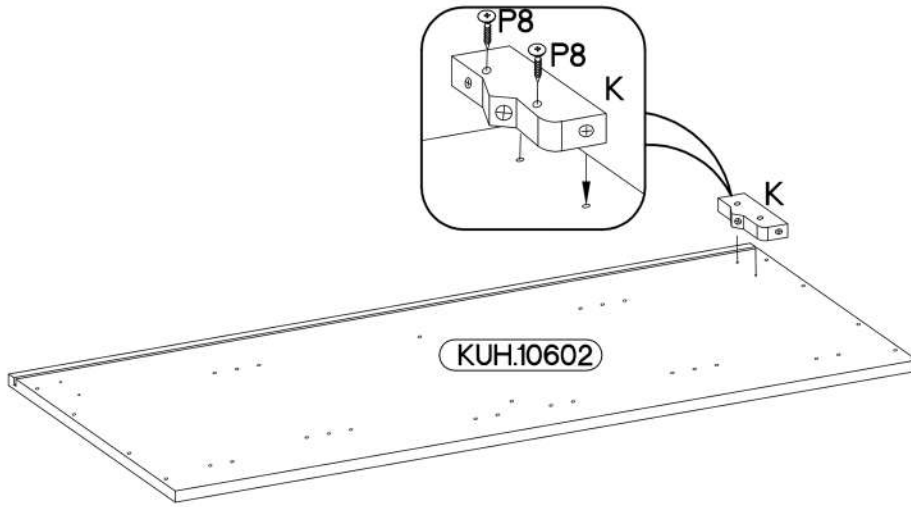
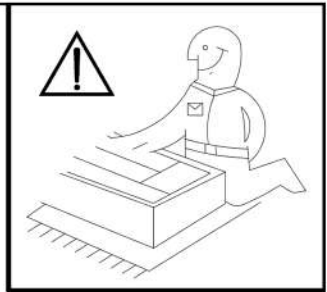

2

6,4 x 50mm

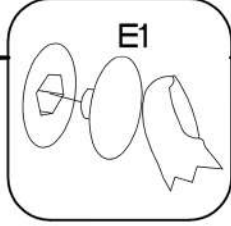
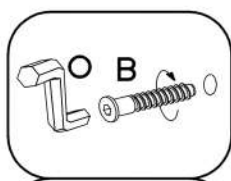
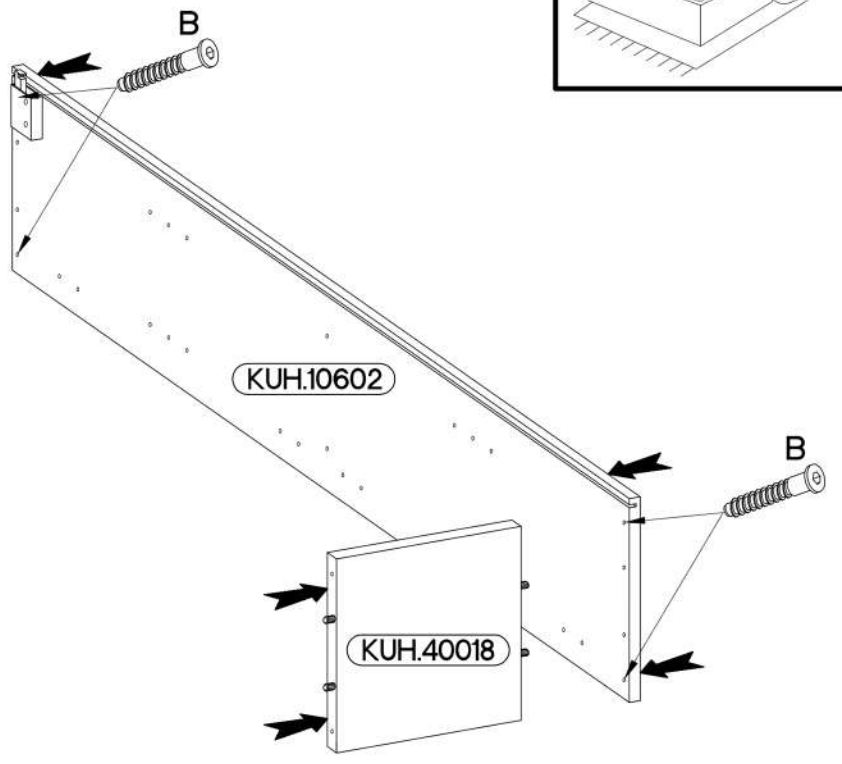
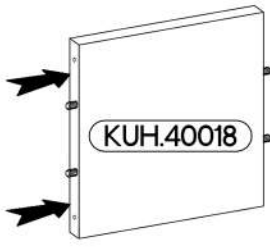
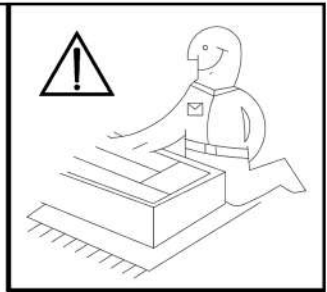
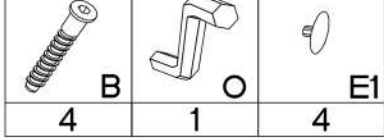

3

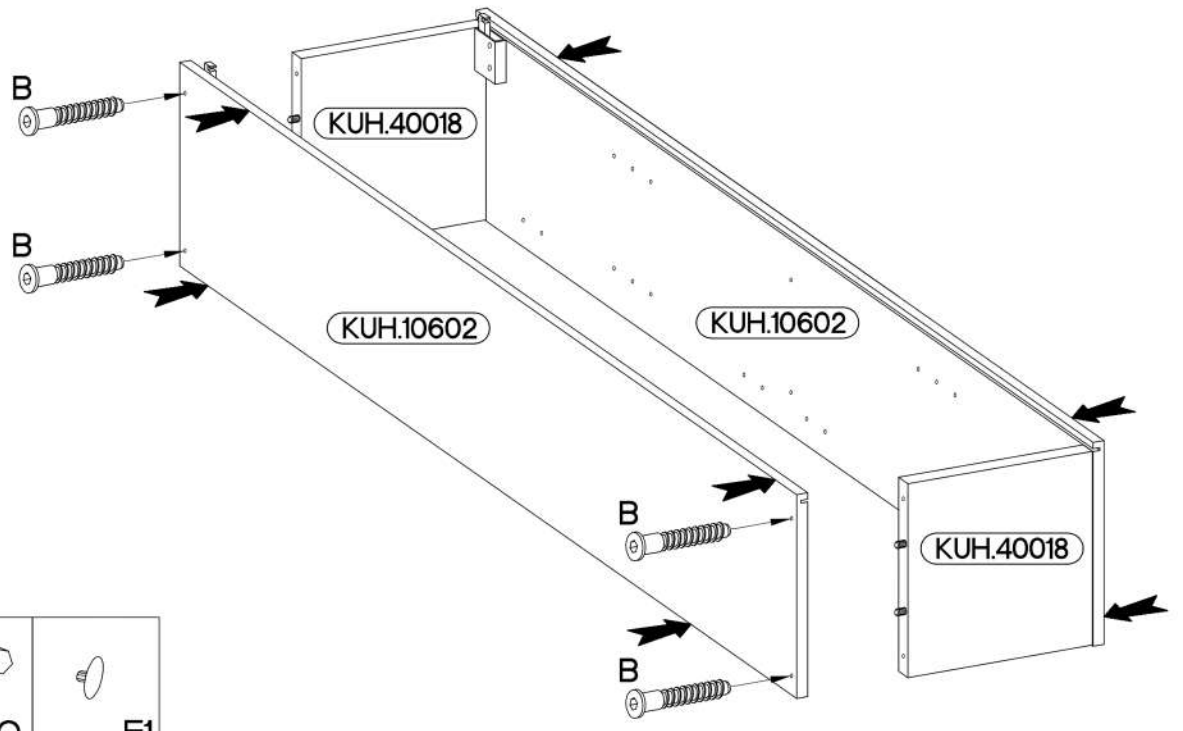

6,4 x 50mm

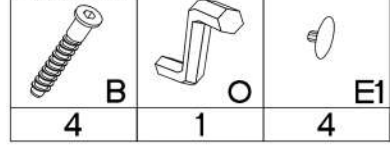

4

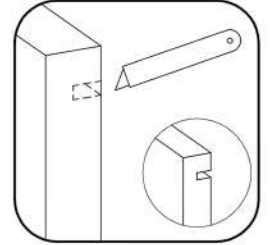
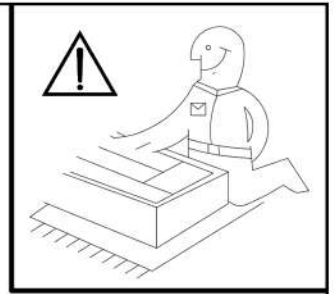
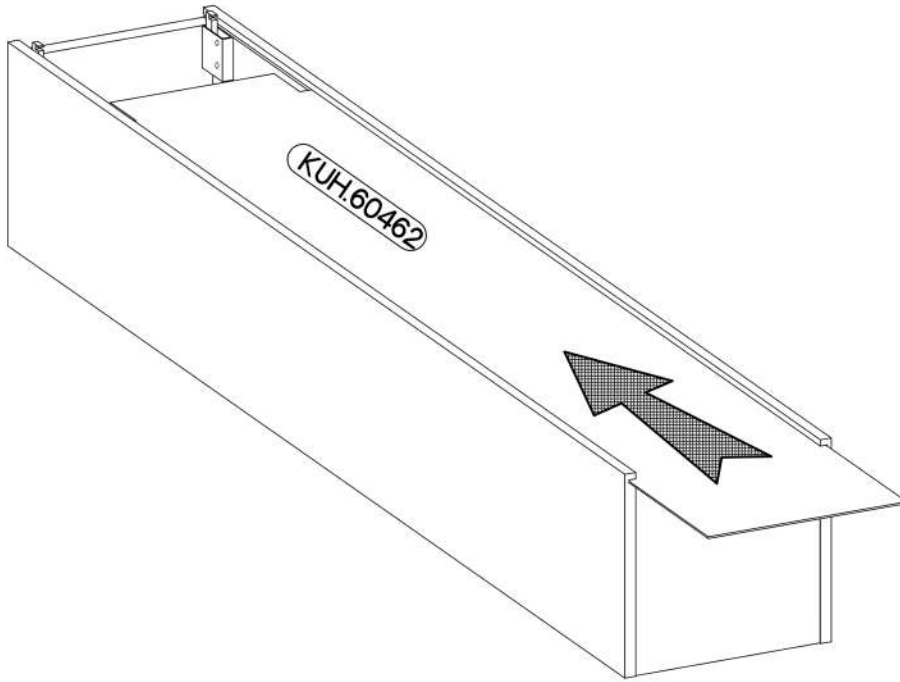

5

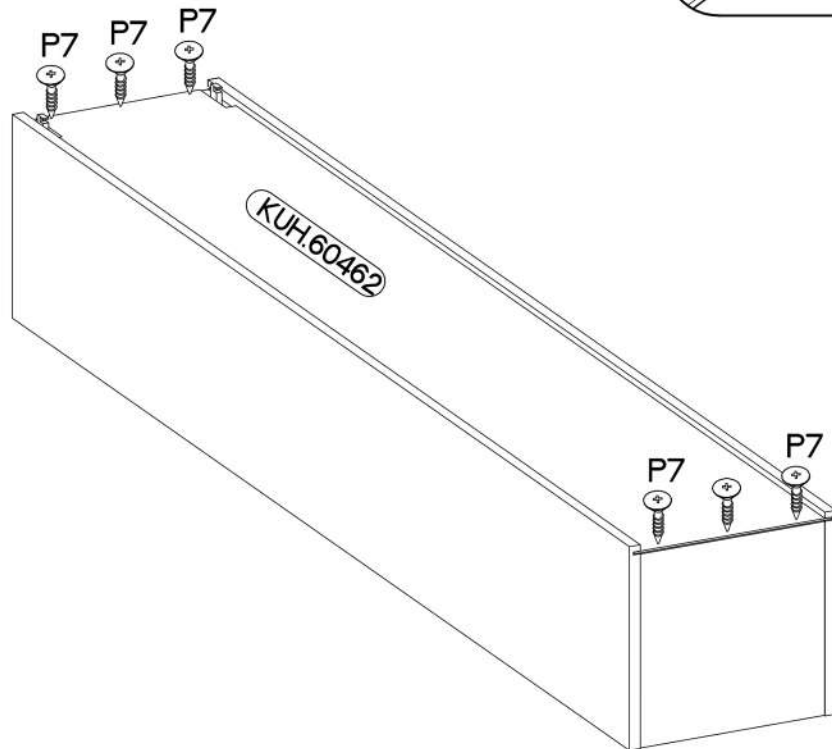
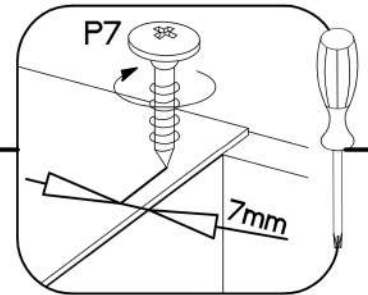
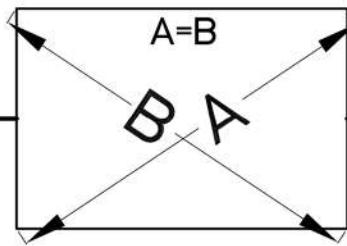

6

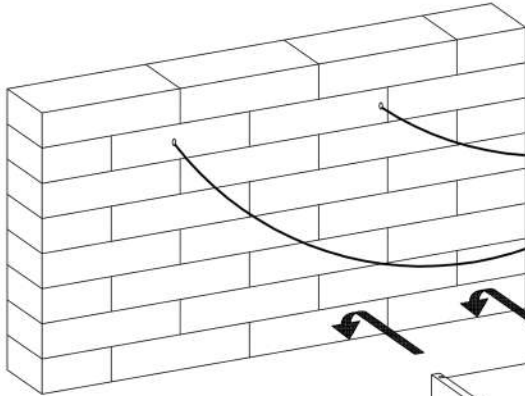
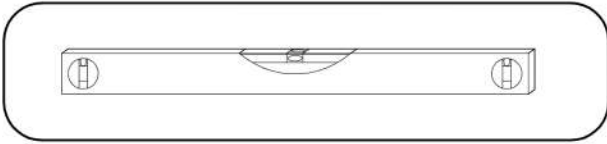

A

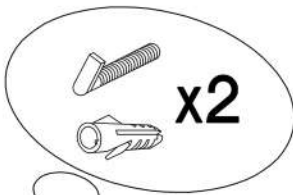
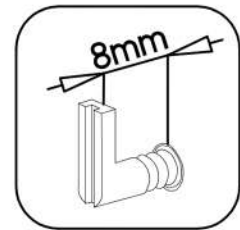
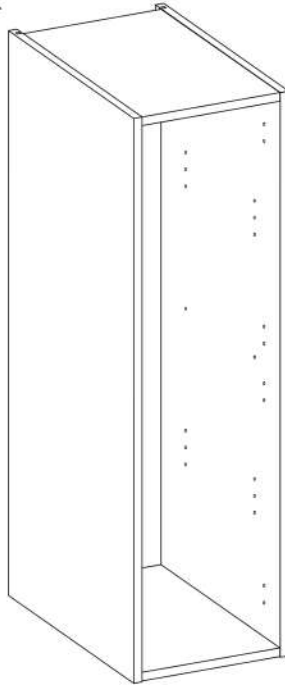
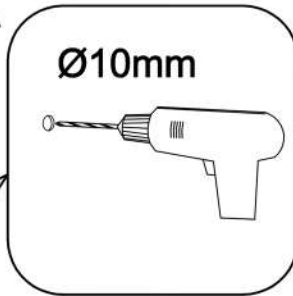

C

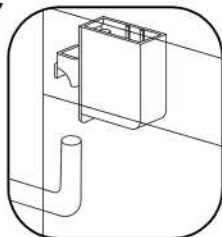

D

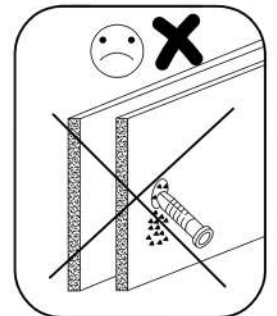
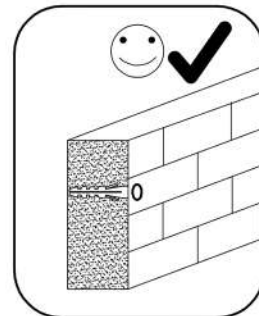
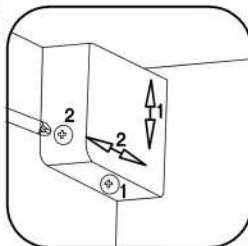

7

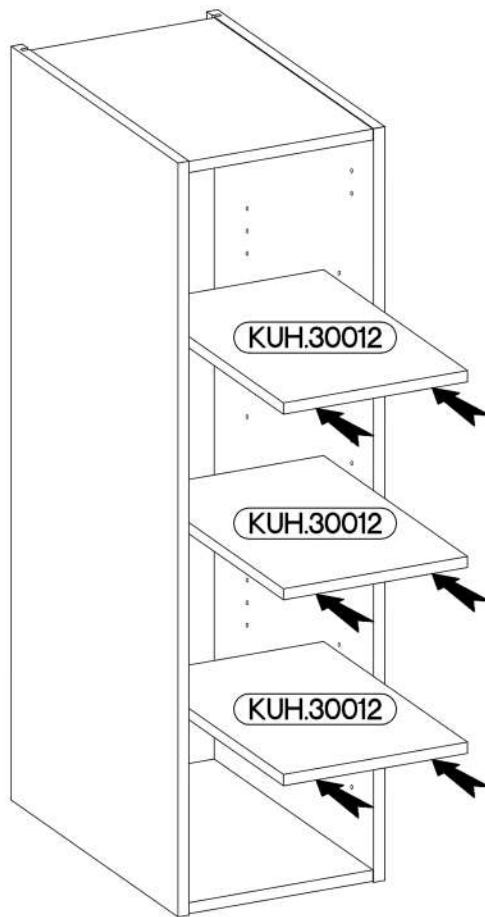
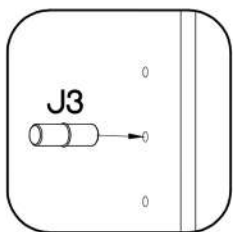
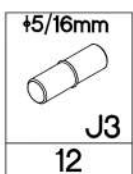

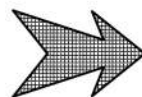
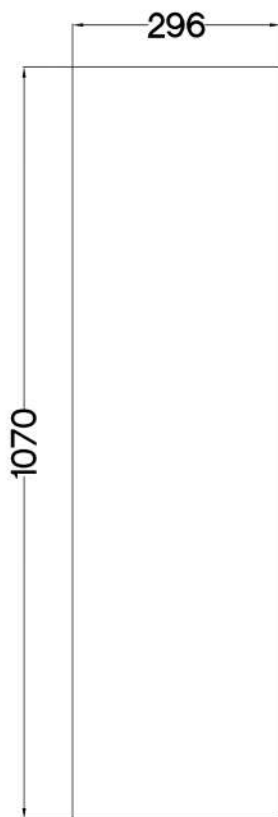

8

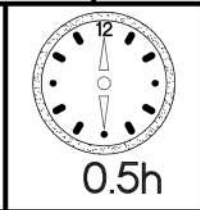
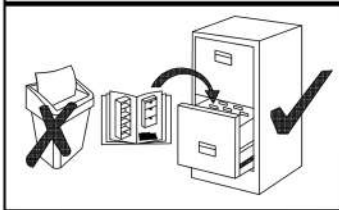
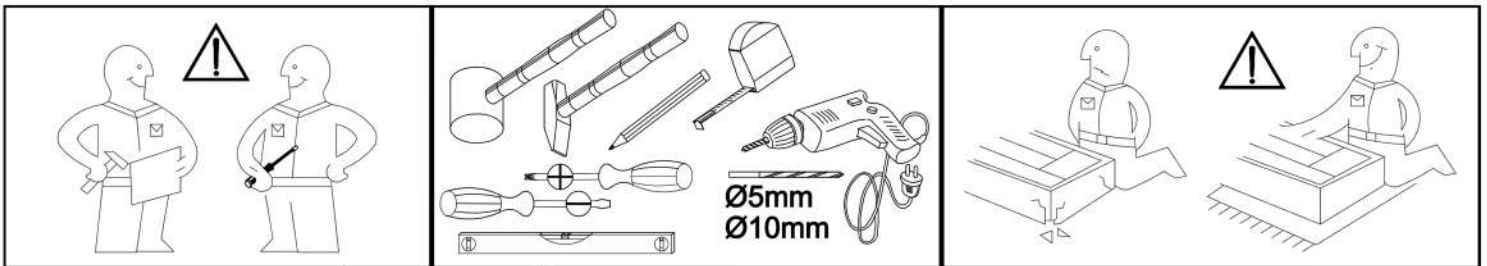

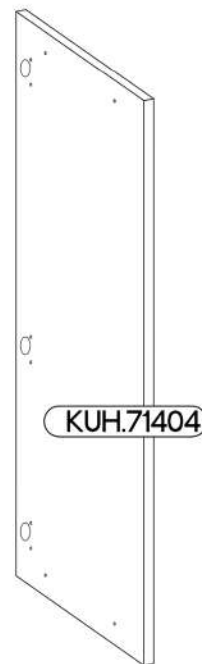
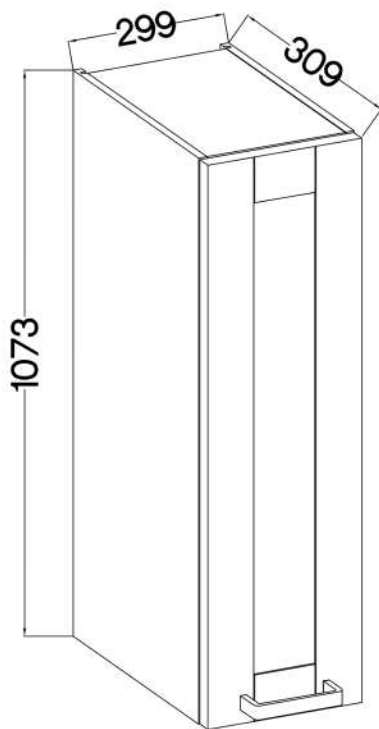

1070X296



L=160mm	M4x27mm
	
S	U8
1	2

KUH.71404	1070x296x19
-----------	-------------



1

LEFT

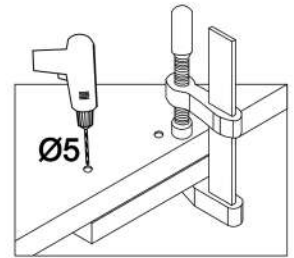
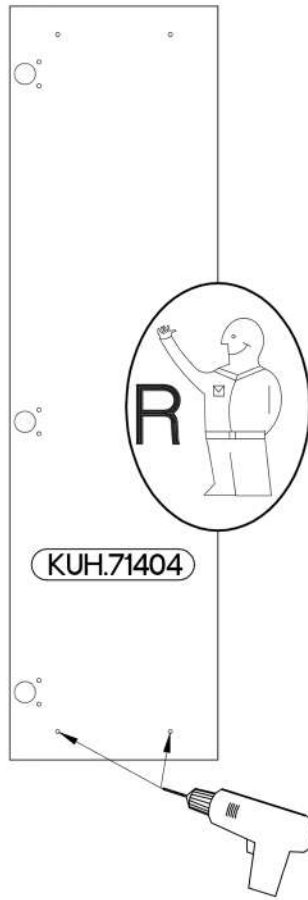
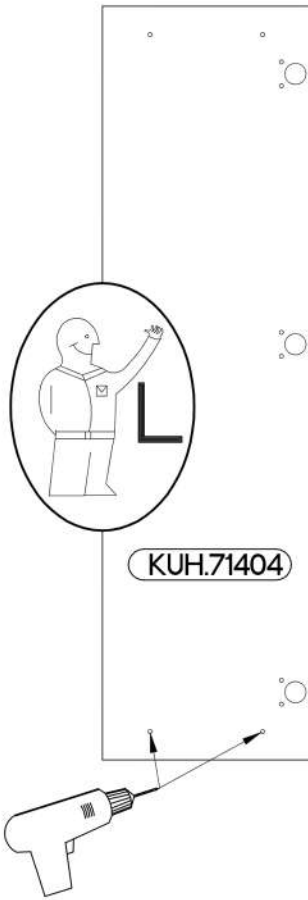
RIGHT



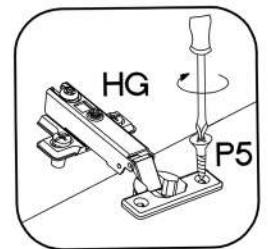
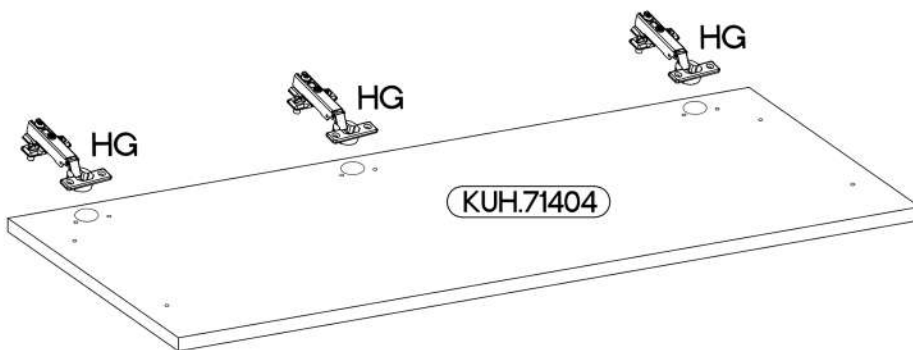

2

±35/0mm	±3.5x13mm
	
HG	P5
3	6



3

L=160mm	M4x27mm
	
S	U8
1	2

