

# FRISBO 40 G-90 1F

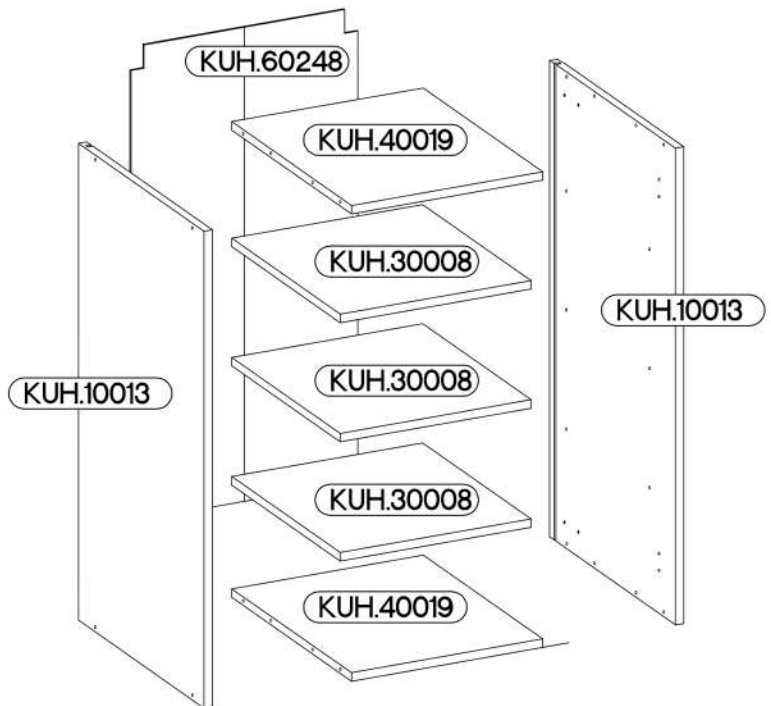

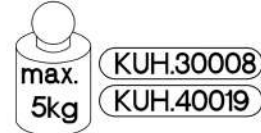
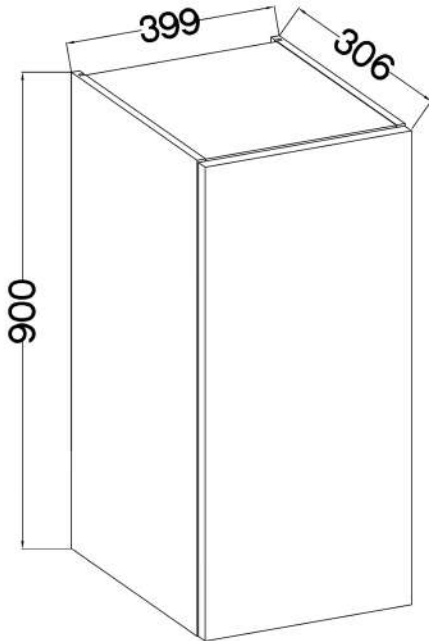
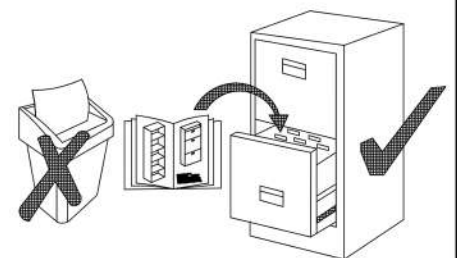

KUH.10013	x2	900x290x16
KUH.30008	x3	366x250x16
KUH.40019	x2	367x276x16
KUH.60248		896x385x2,5

 A 8	 B 8	 E1 8	 HG 2	 P5 4	 P7 8-10	 P8 4
 J 12	 K 2	 O 1				



1

$\pm 8 \times 30 \text{mm}$  A	$\pm 4.0 \times 30 \text{mm}$  P8	 K
8	4	2

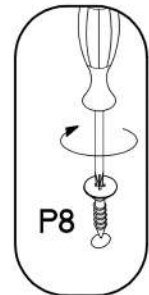
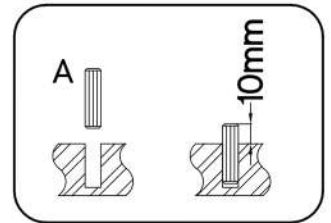
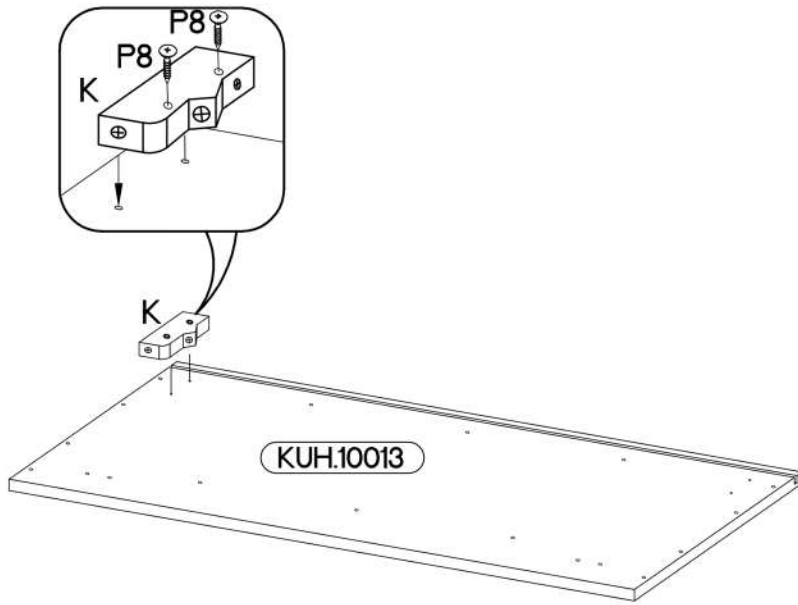
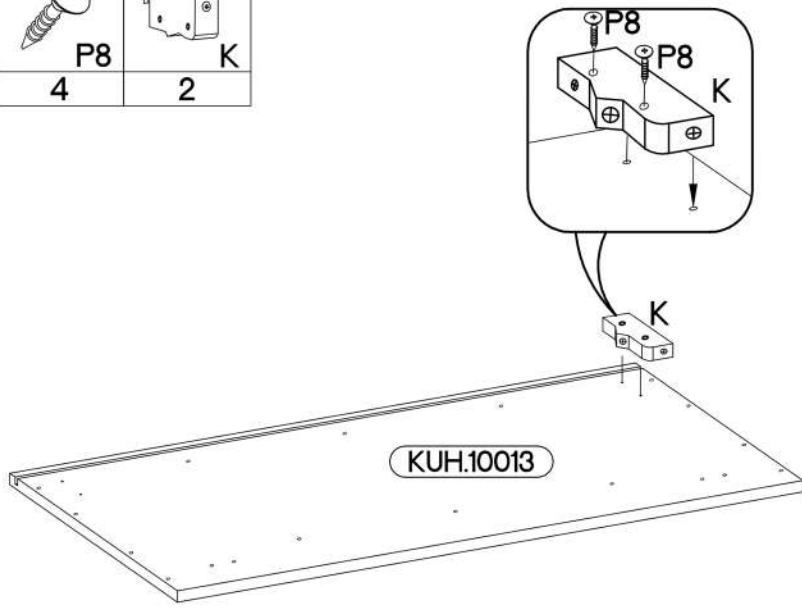
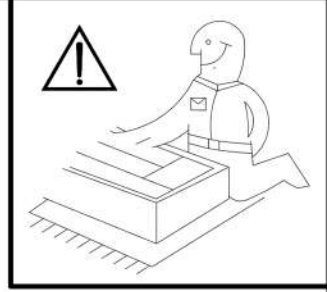

2

6,4 x 50mm

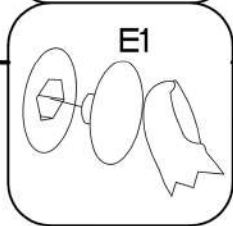
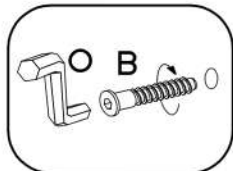
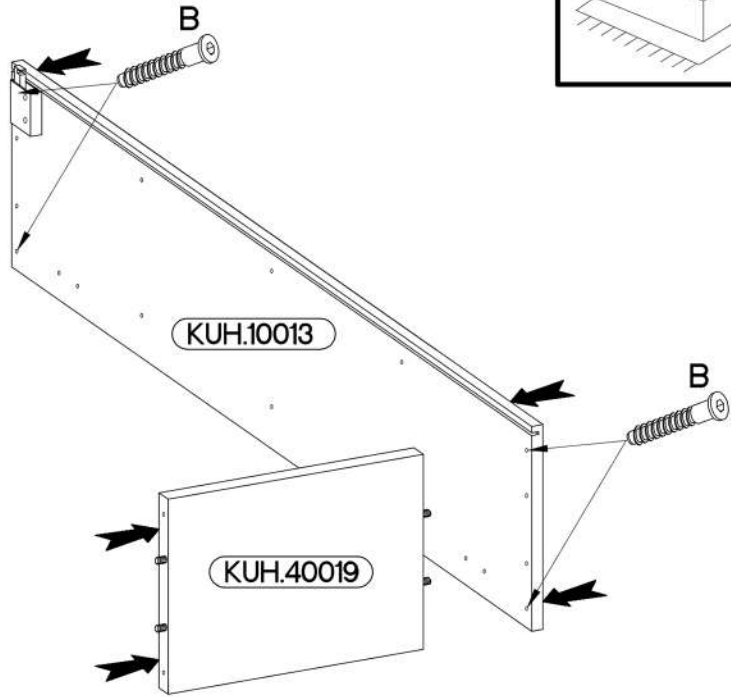
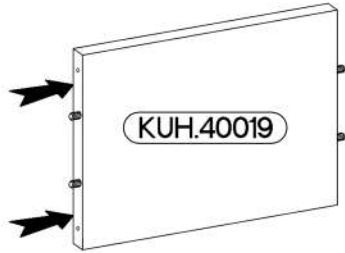
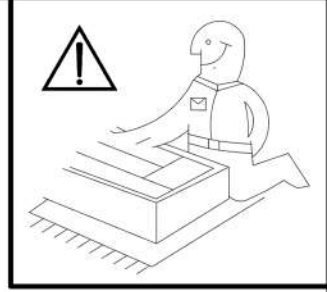
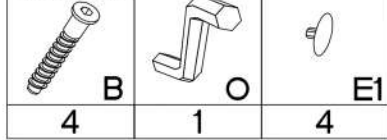

3

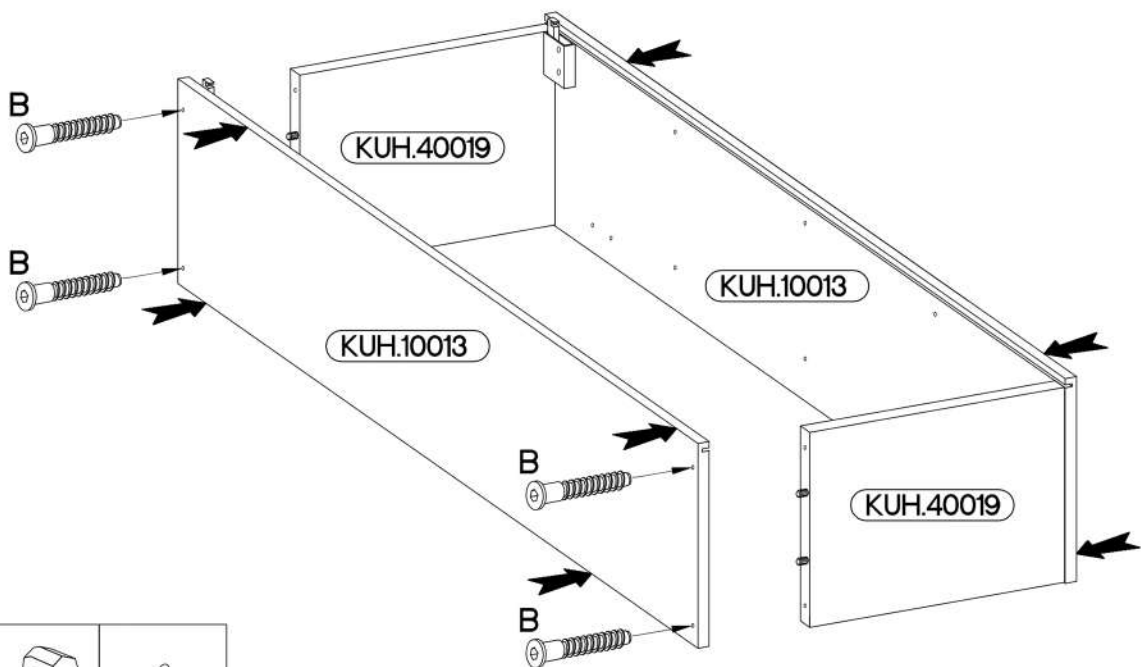

6,4 x 50mm

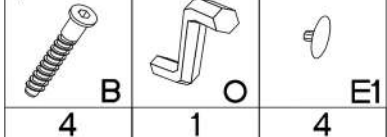

4

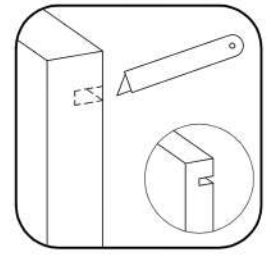
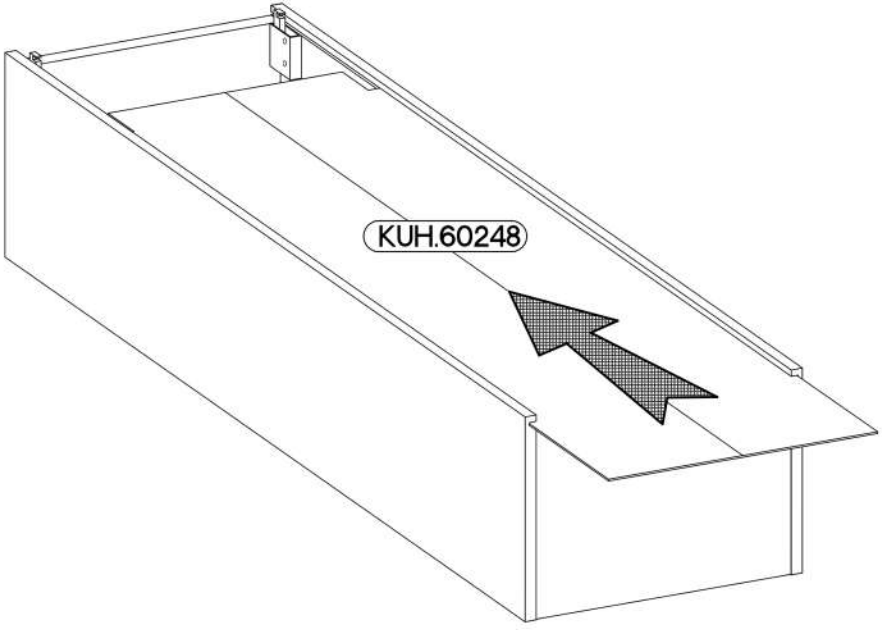
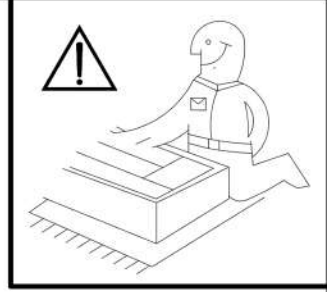

5

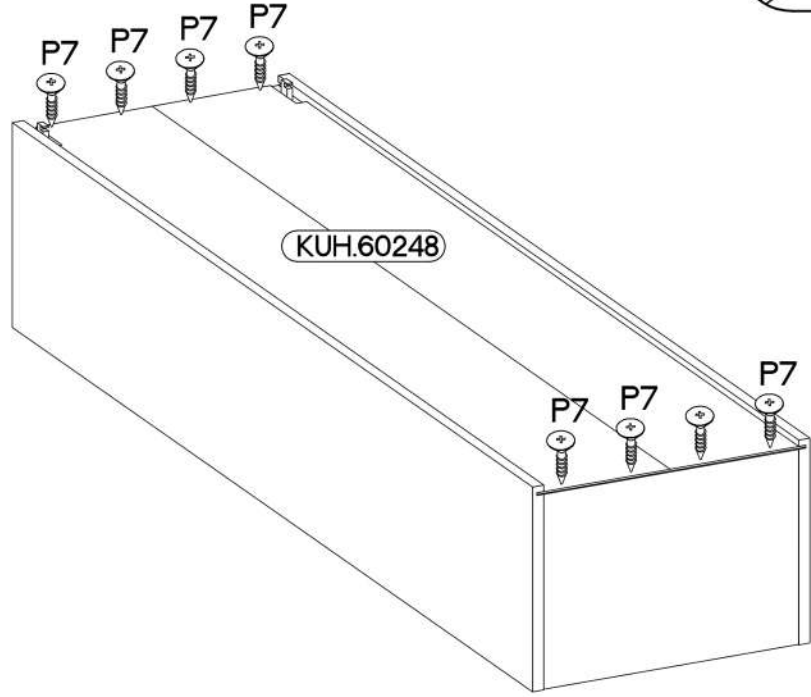
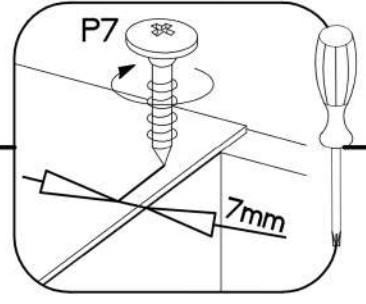
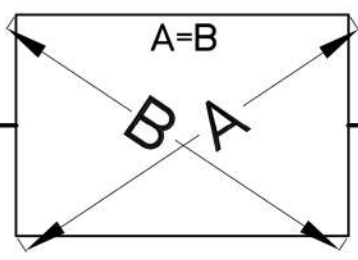
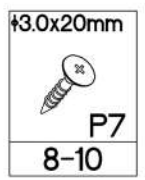

6

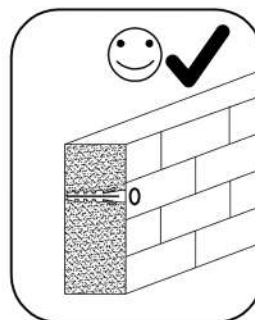
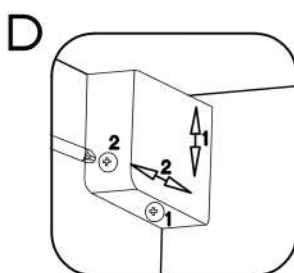
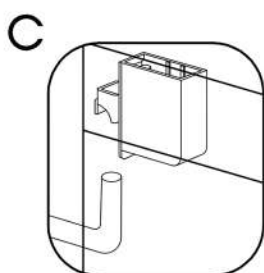
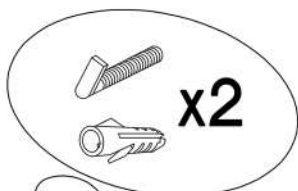
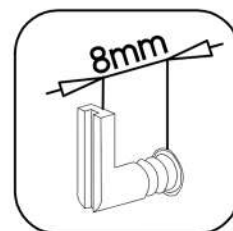
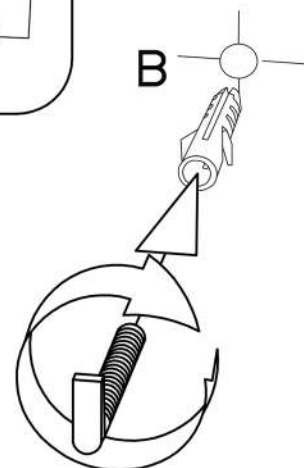
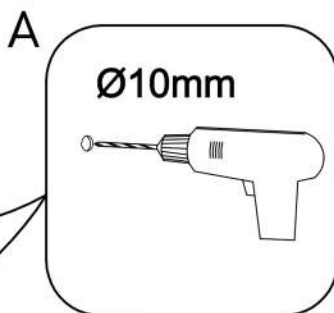
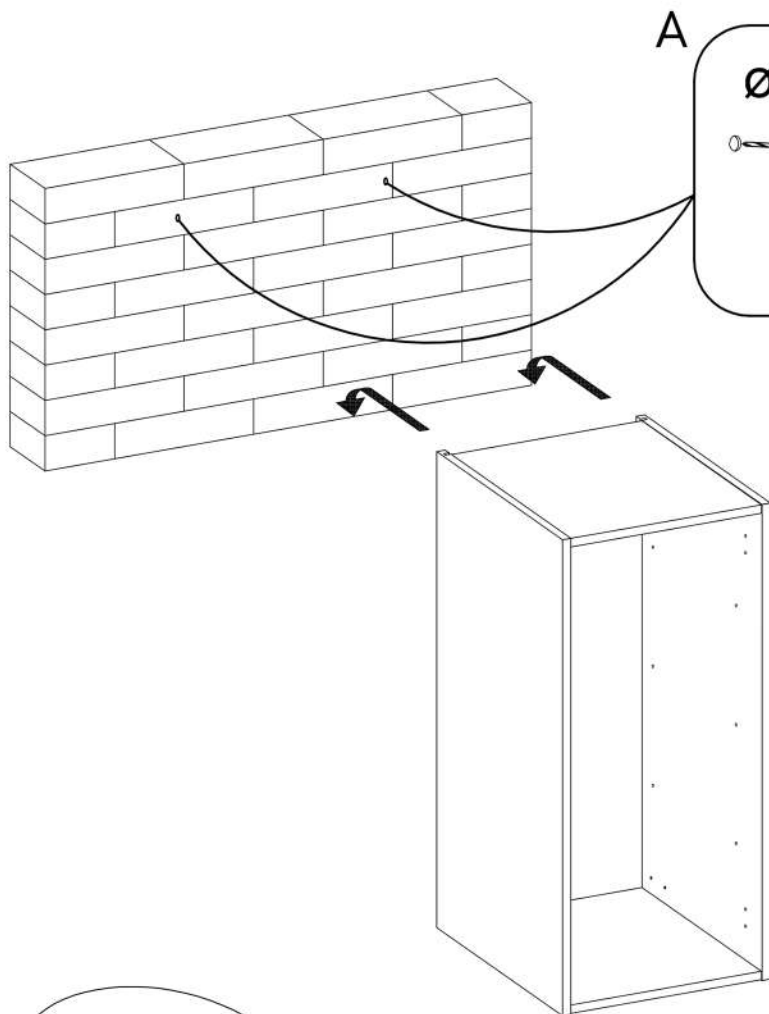
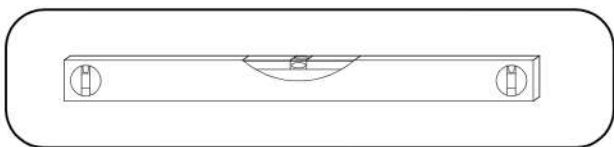

7

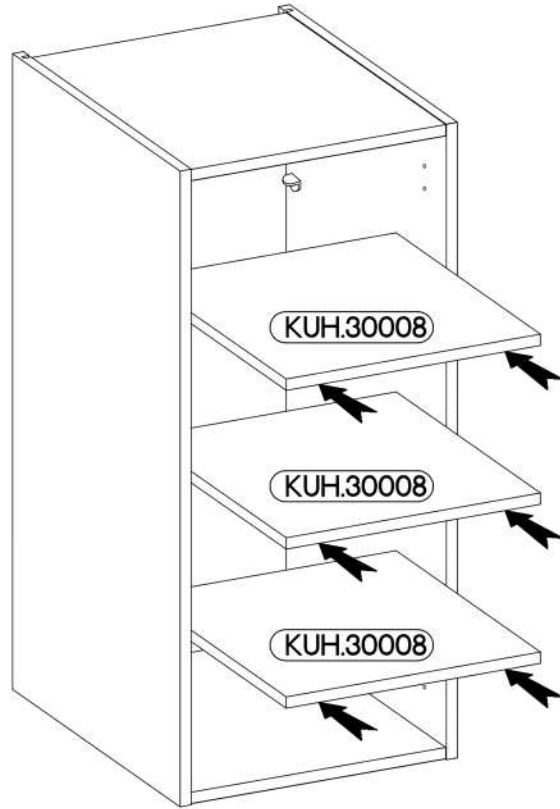
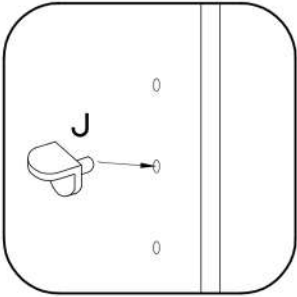
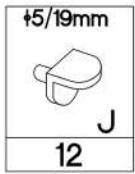



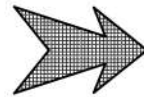
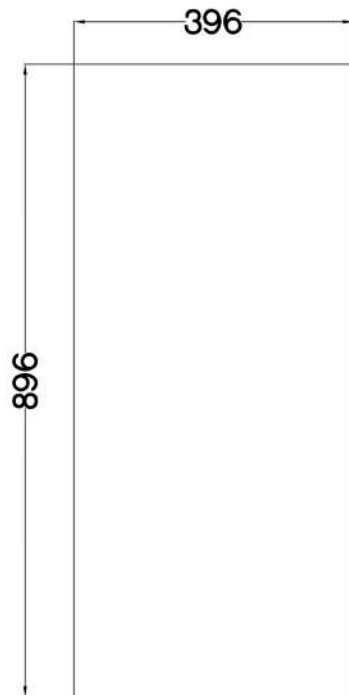

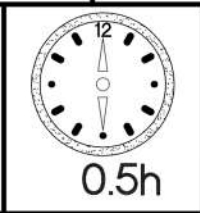
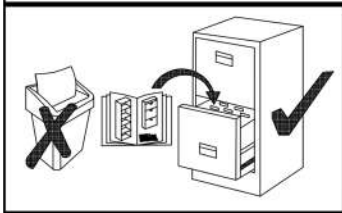
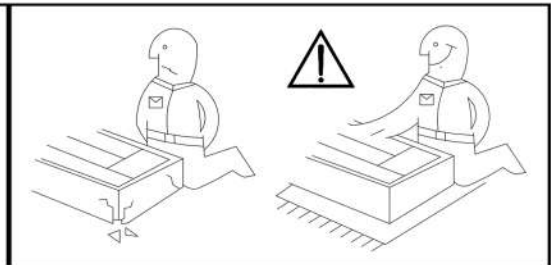
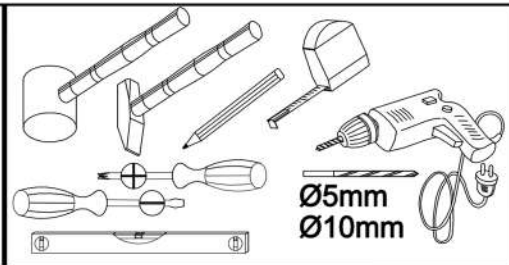
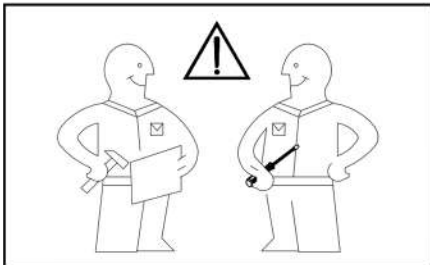
8



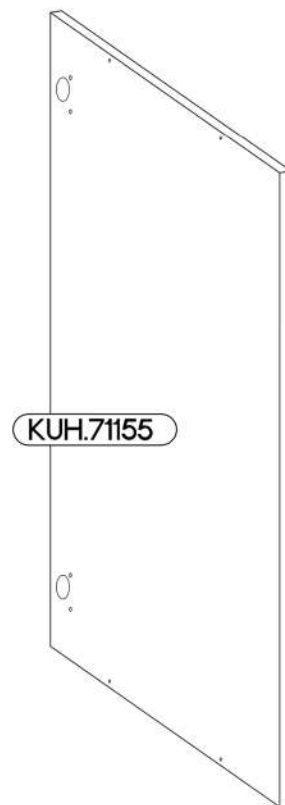
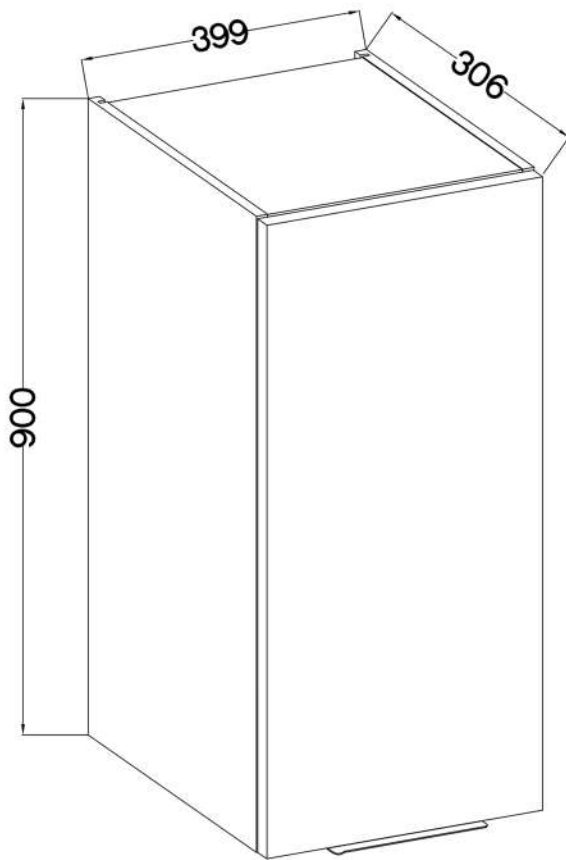
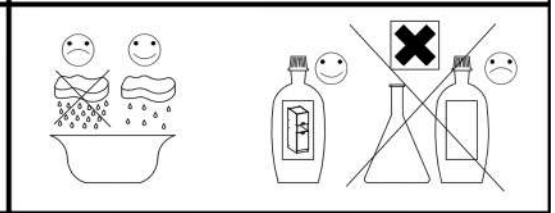

896x396



L=192mm	+7/2mm
	
 S	J5
1	2

KUH.71155	896x396x16
-----------	------------

# 1

$\varnothing 35/0\text{mm}$ [CD] HG 2	$\varnothing 3.5 \times 13\text{mm}$ P5 4	$\varnothing 7/2\text{mm}$ J5 2
---	---	---------------------------------------

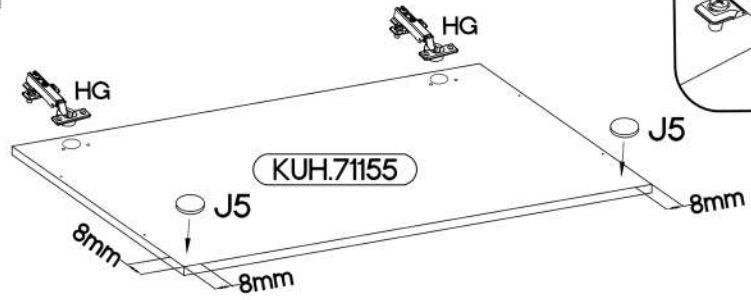
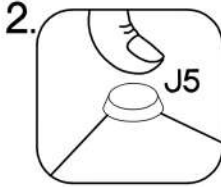
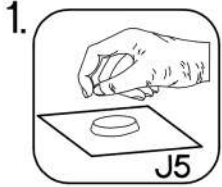

# 2

L=192mm 
S 1

