

FRISBO 40 G-72 1F

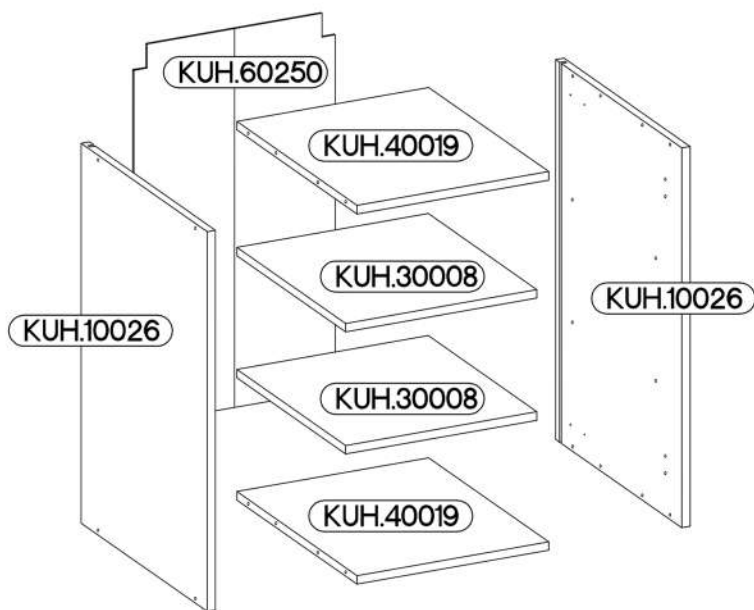

KUH.30008
KUH.40019

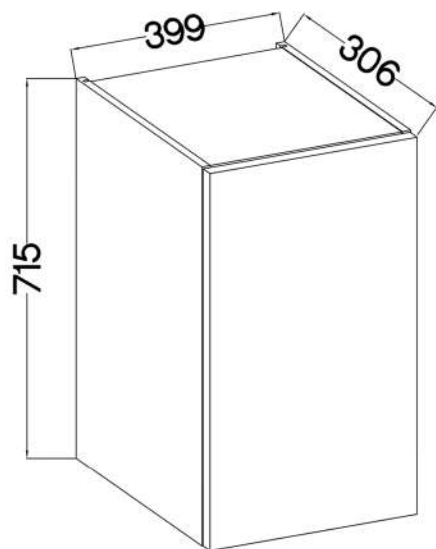

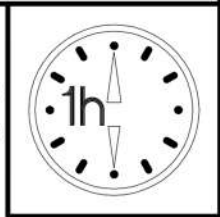

KUH.10026 x2	715x290x16
KUH.30008 x2	366x250x16
KUH.40019 x2	367x276x16
KUH.60250	713x385x2,5

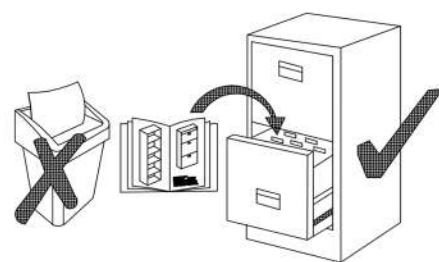
+8x30mm A 8	6,4 x 50mm B 8	E1 8	+35/0mm HG 2			
+5/19mm J 8	K 2	O 1	+3.5x13mm P5 4	+3.0x20mm P7 8-10	+4.0x30mm P8 4	



1

 +8x30mm A	 +4.0x30mm P8	 K
8	4	2

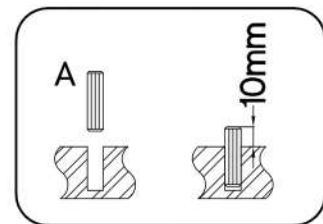
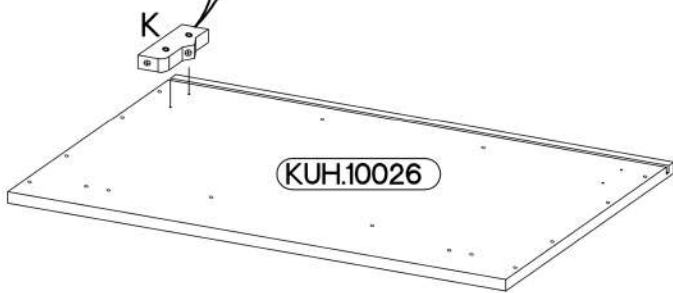
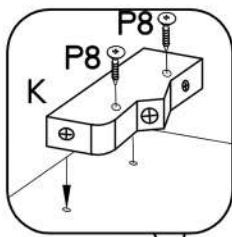
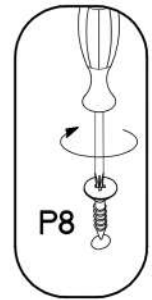
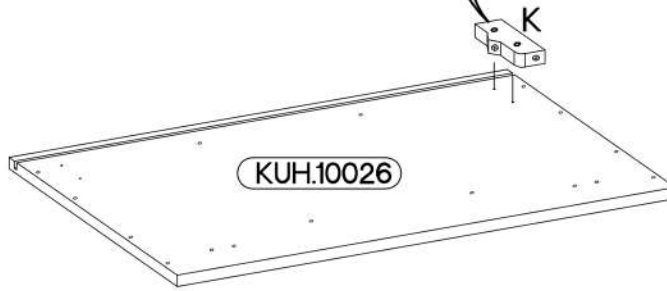
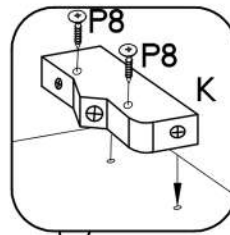
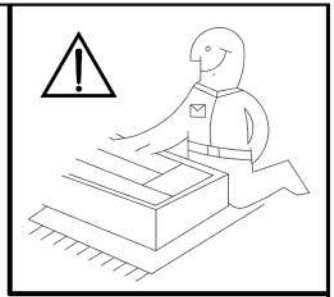

2

6,4 x 50mm

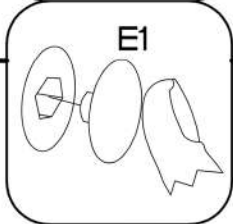
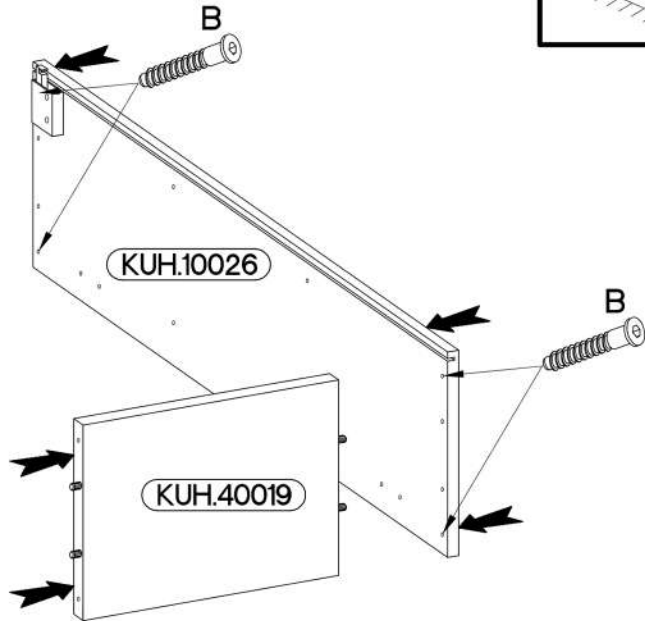
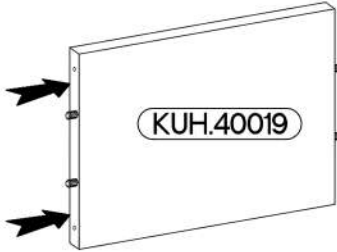
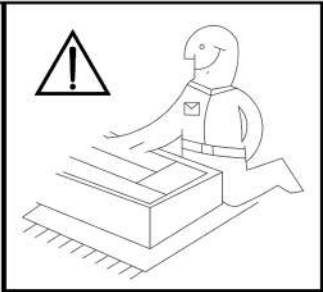
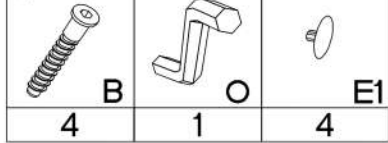

3

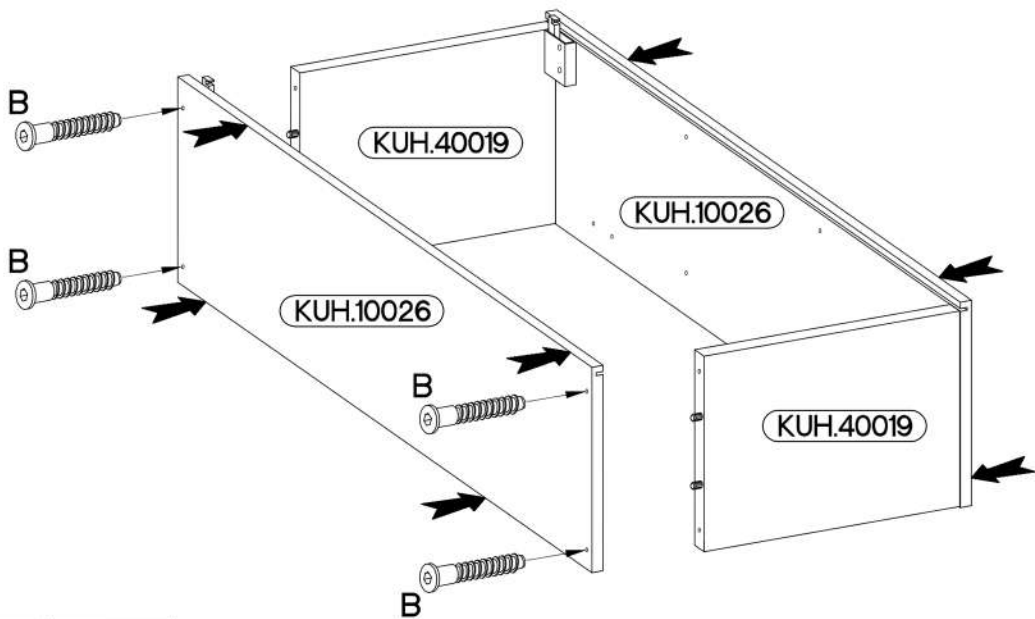

6,4 x 50mm

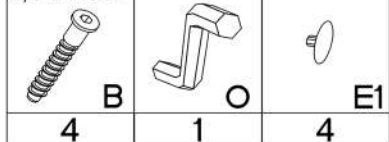

4

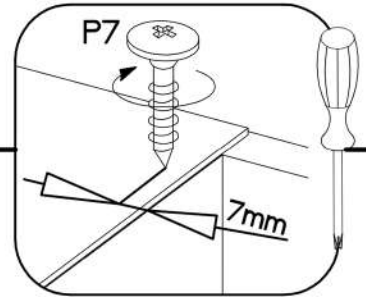
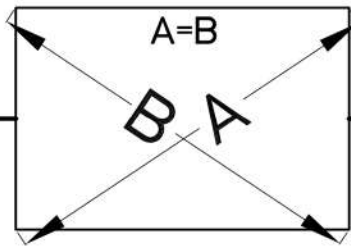
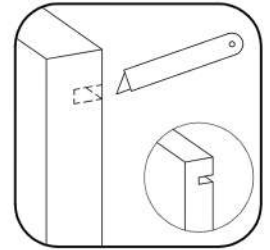
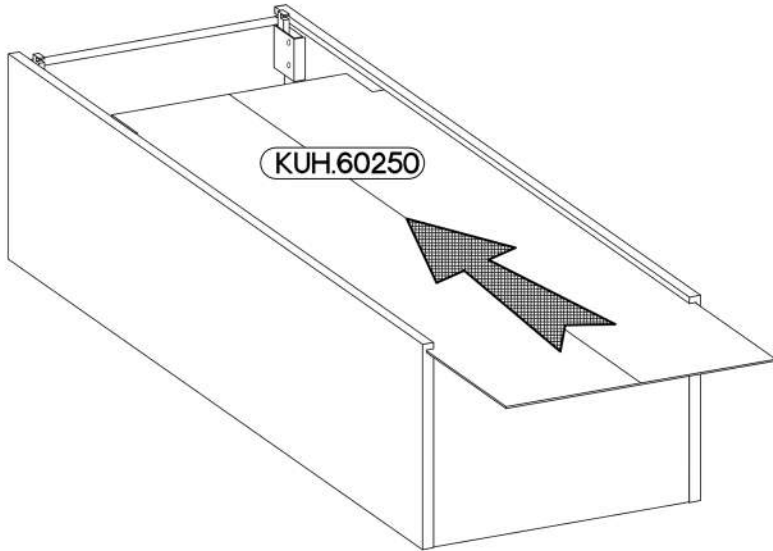
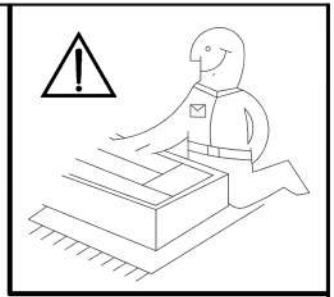

5

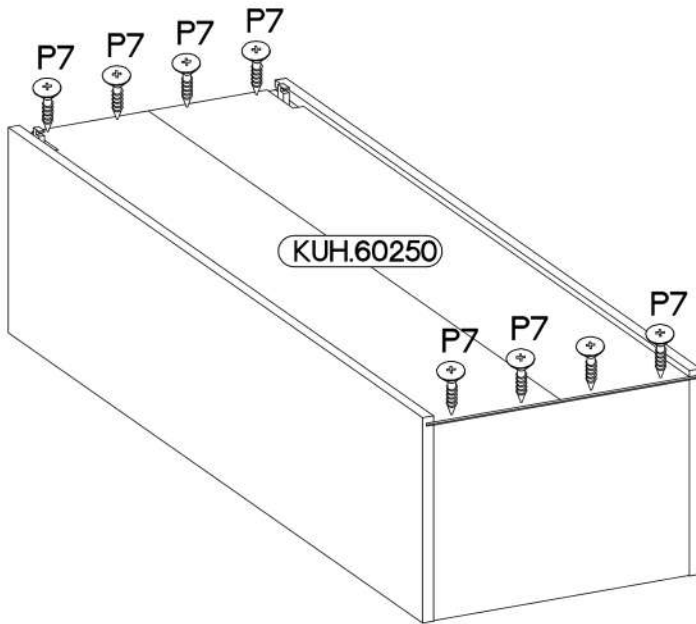

6

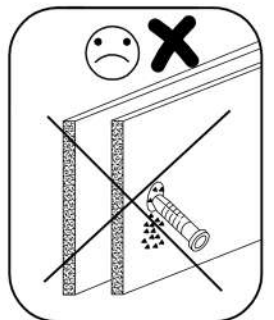
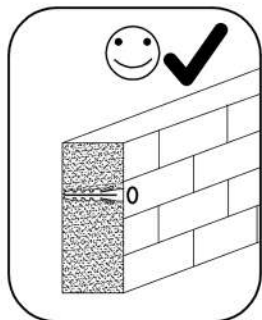
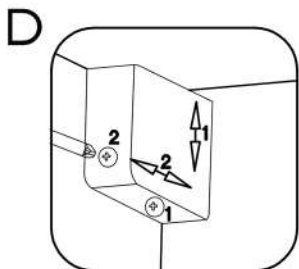
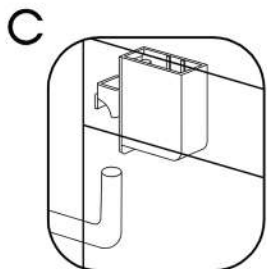
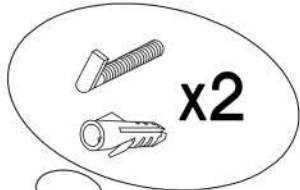
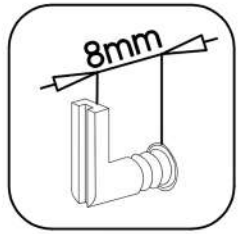
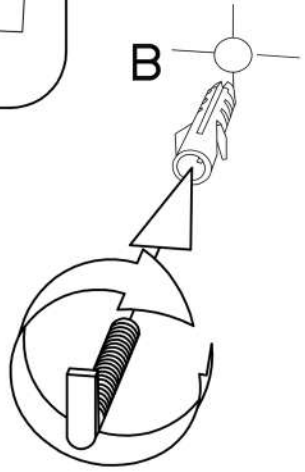
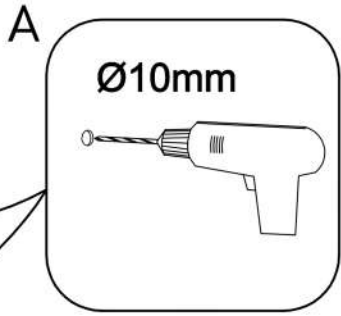
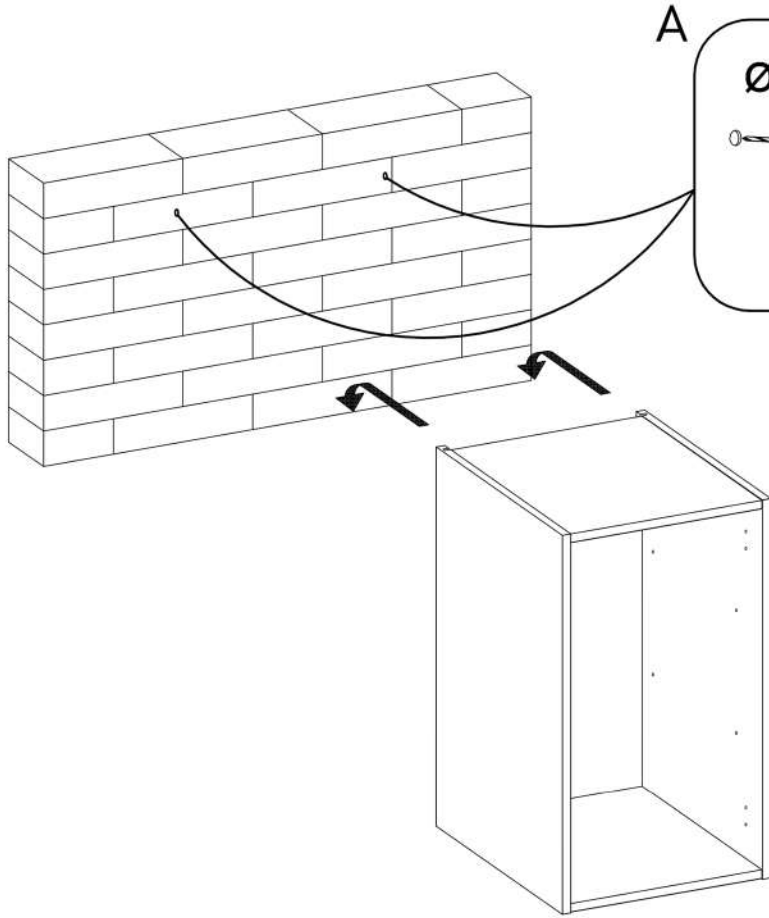
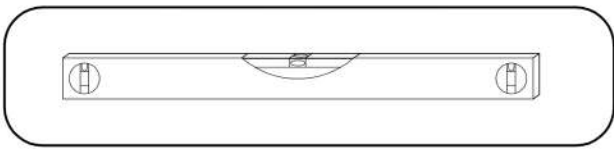

7

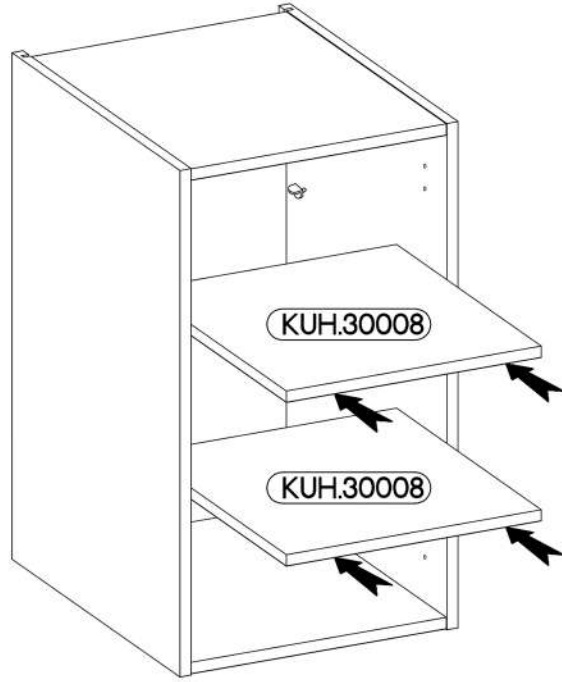
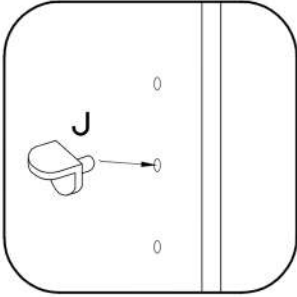
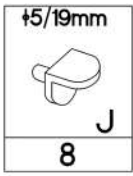

8

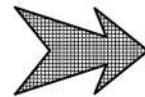
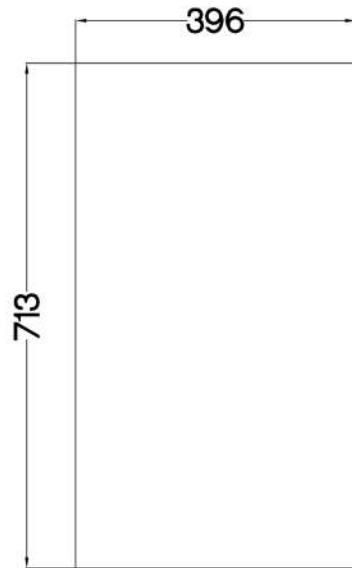

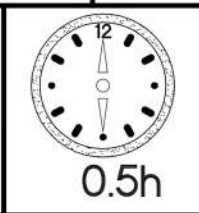
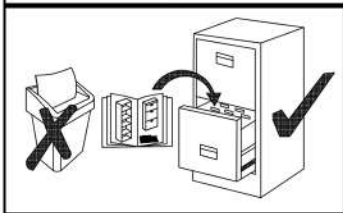
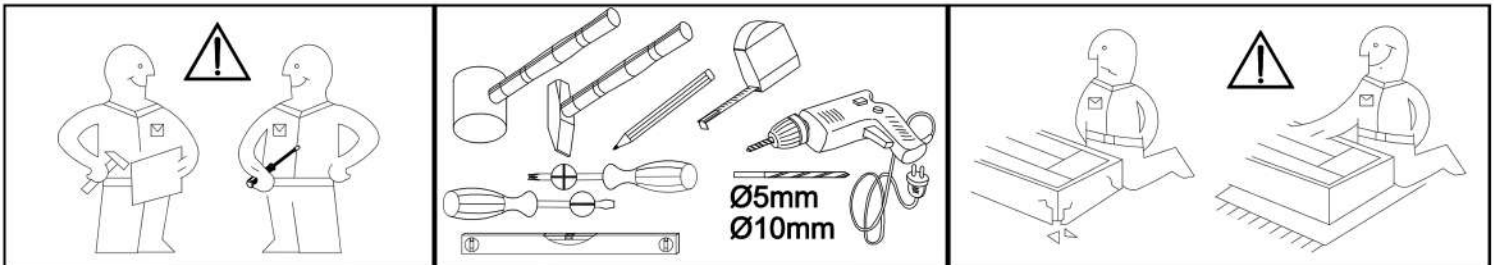

713x396

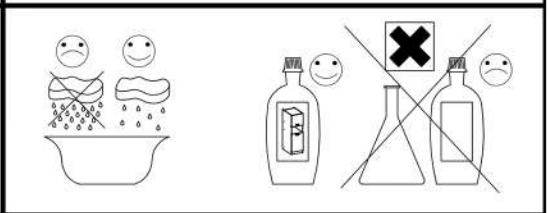

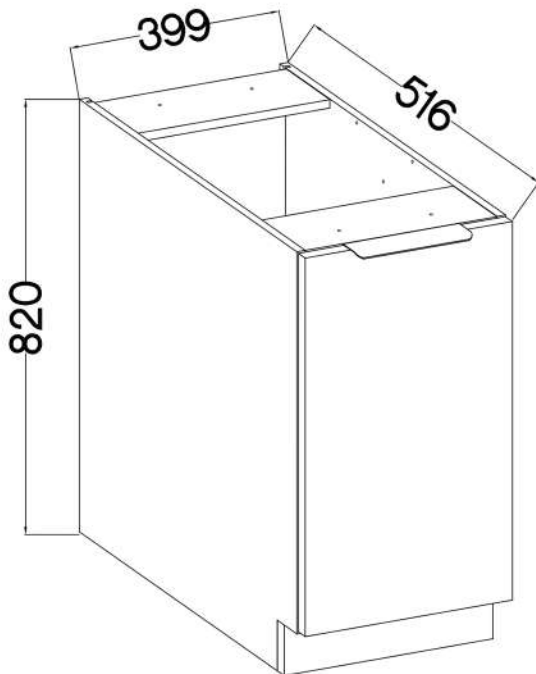

40 D 1F BB

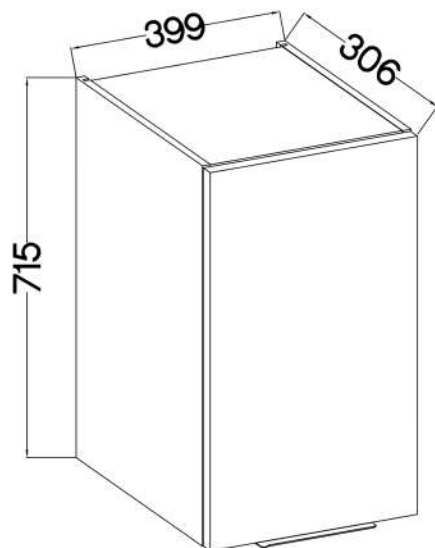

40 G-72 1F



KUH.71147

L=192mm	±7/2mm
	
S	J5
1	2

KUH.71147	713x396x16
-----------	------------

1

$\pm 35/0\text{mm}$ [CD] HG 2	$\pm 3.5 \times 13\text{mm}$ P5 4	$\pm 7/2\text{mm}$ J5 2
-------------------------------------	---	-------------------------------

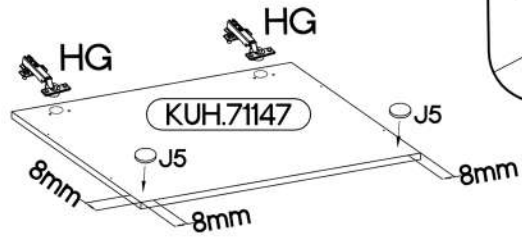
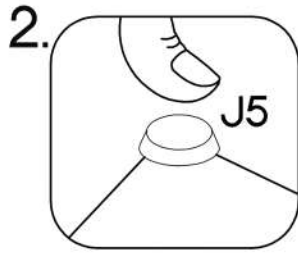
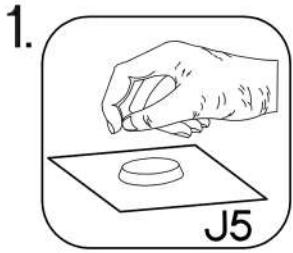
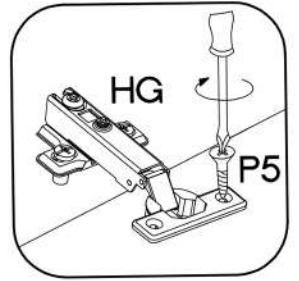

2

40 D 1F BB

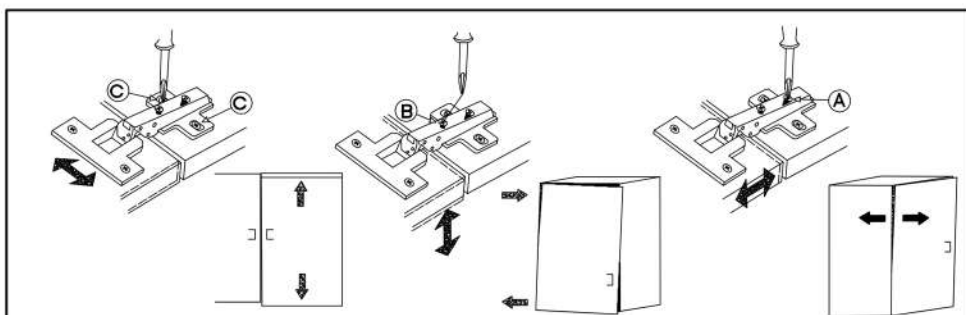
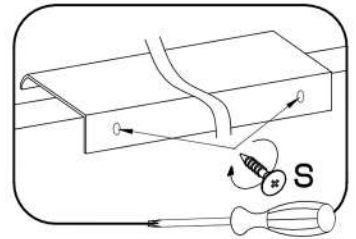
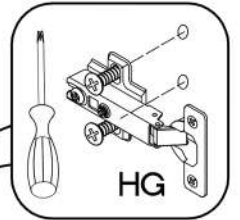
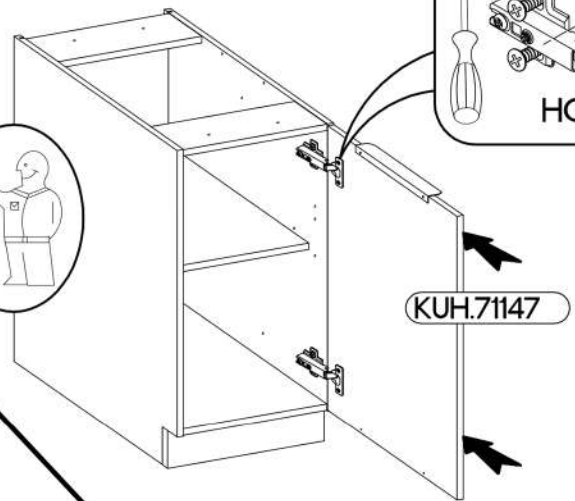
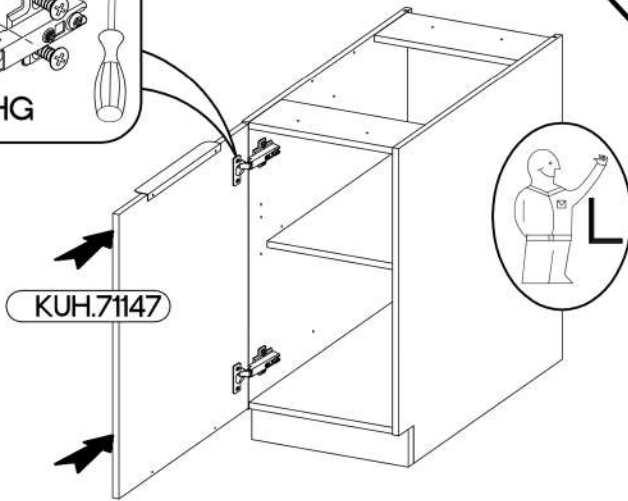
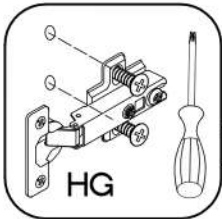
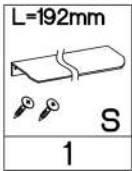

3

40 G-72 1F

