

FRISBO 45 G-90 1F

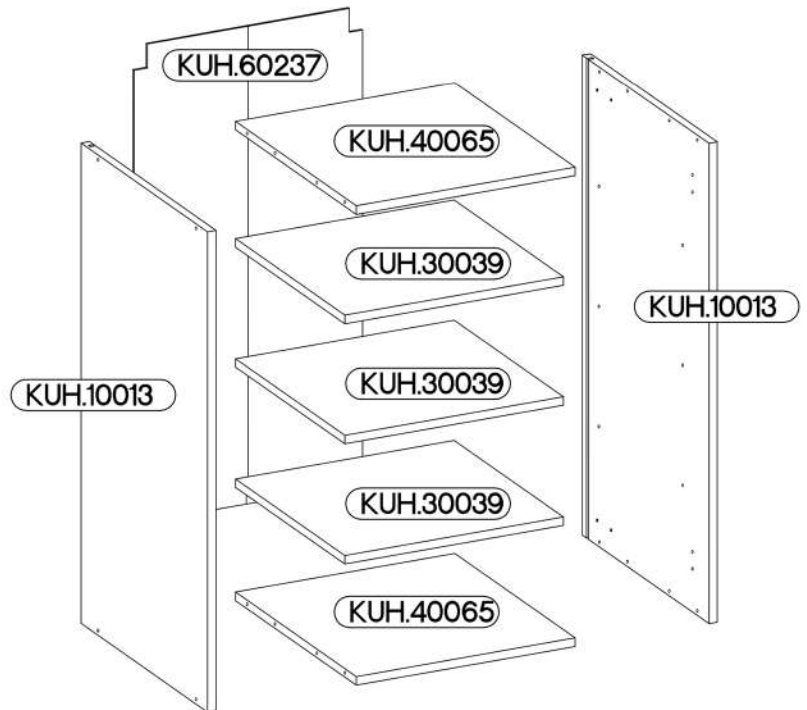

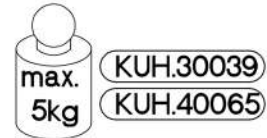
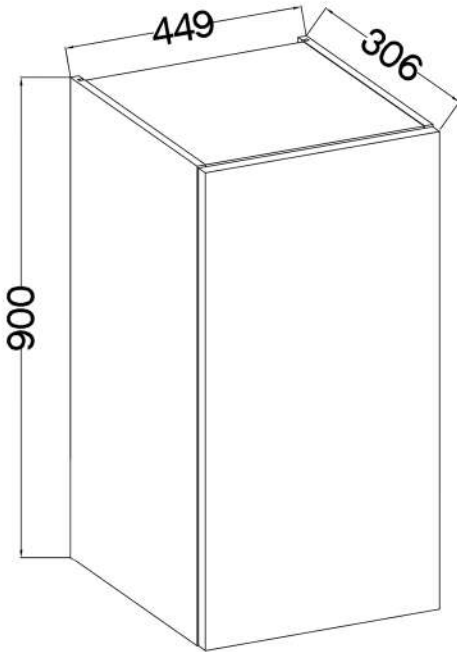
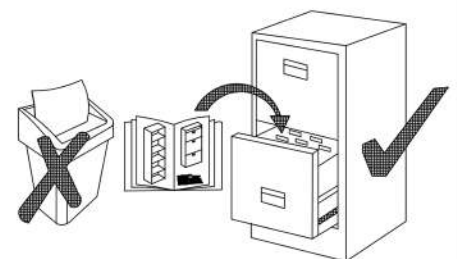

| | |
|--------------|-------------|
| KUH.10013 x2 | 900x290x16 |
| KUH.30039 x3 | 416x250x16 |
| KUH.40065 x2 | 417x276x16 |
| KUH.60237 | 896x435x2,5 |

| | | | |
|--------------------|----------------------|---------|-------------------------|
| +8x30mm A 8 | 6,4 x 50mm B 8 | E1 8 | +35/0mm HG 2 |
| +5/19mm J 12 | K 2 | O 1 | +3.5x13mm P5 4 |
| | | | +3.0x20mm P7 8-10 |
| | | | +4.0x30mm P8 4 |



1

| | | |
|--|---|---|
| $\pm 8 \times 30 \text{mm}$  A 8 | $\pm 4.0 \times 30 \text{mm}$  P8 4 |  K 2 |
|--|---|---|

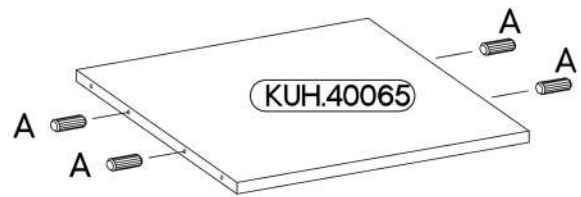
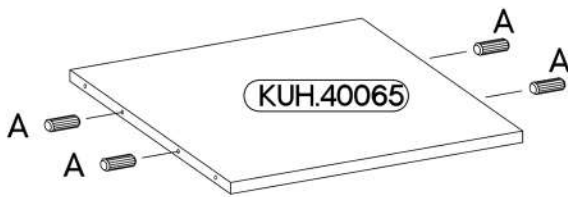
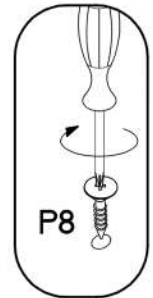
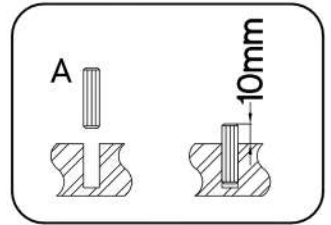
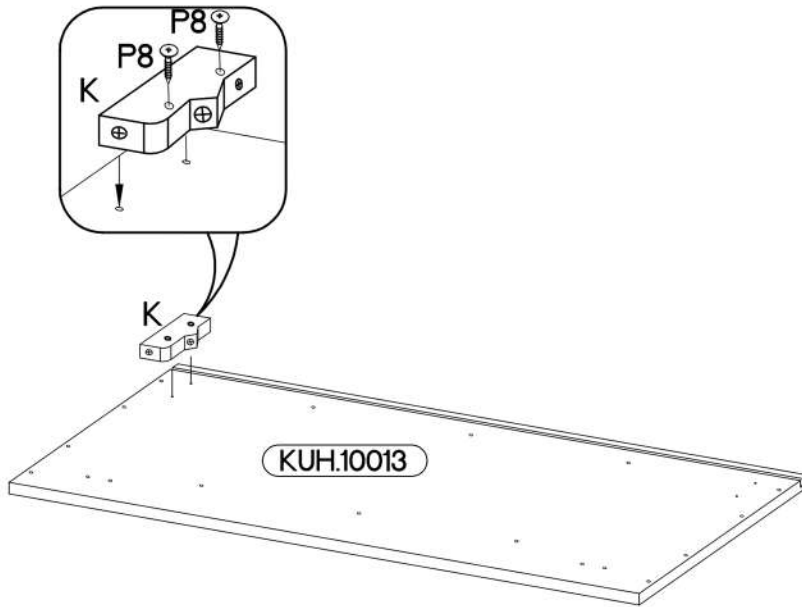
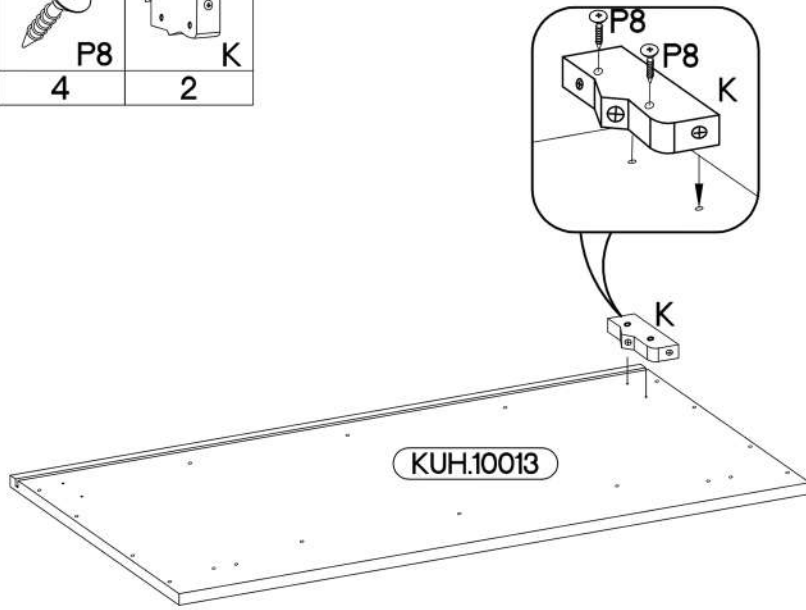
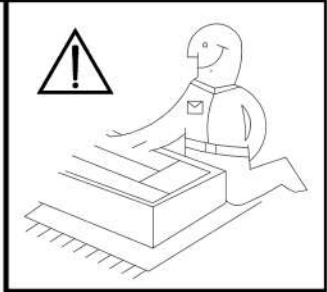

2

6,4 x 50mm

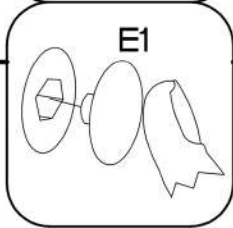
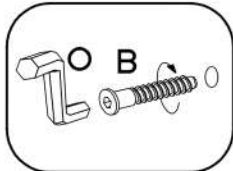
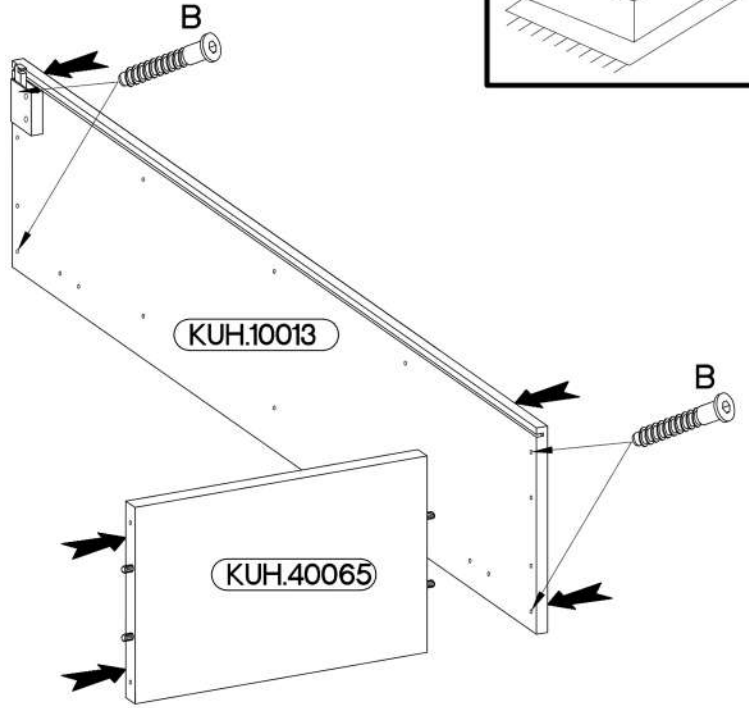
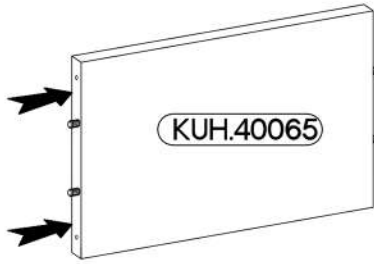
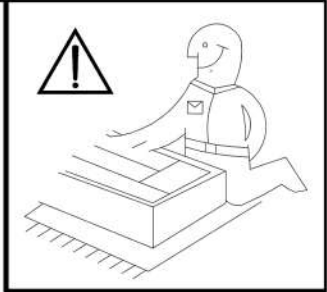
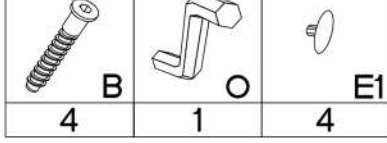

3

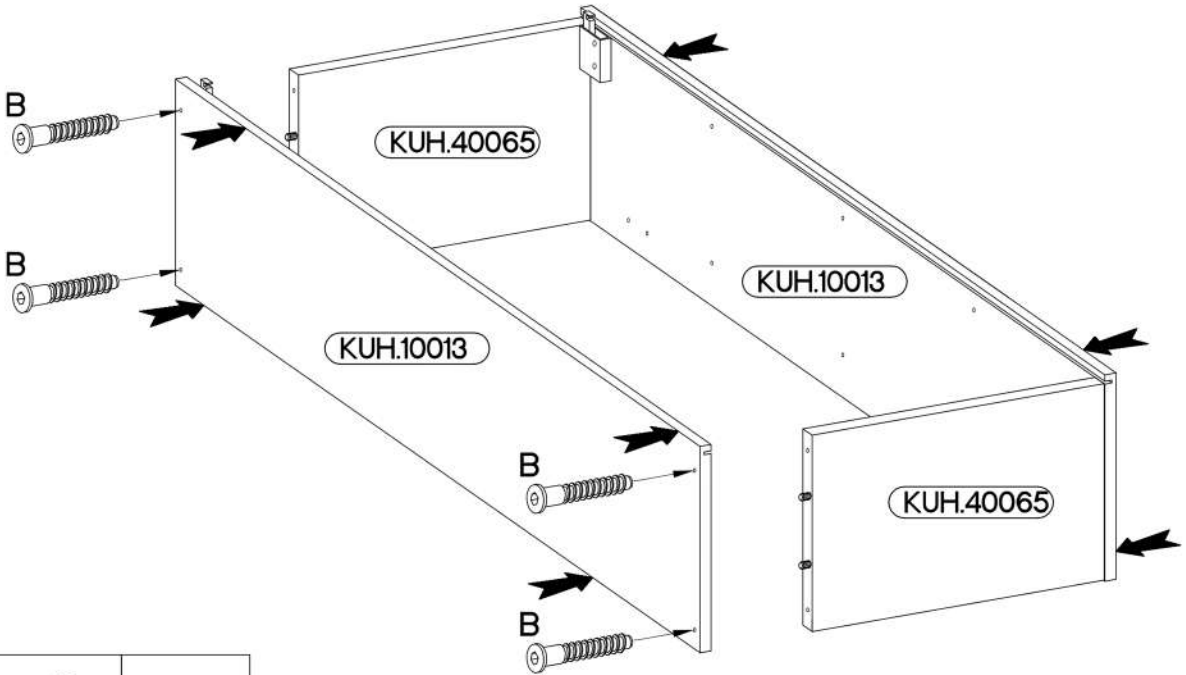

6,4 x 50mm

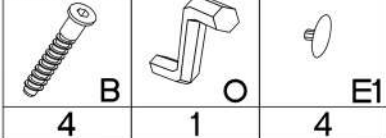

4

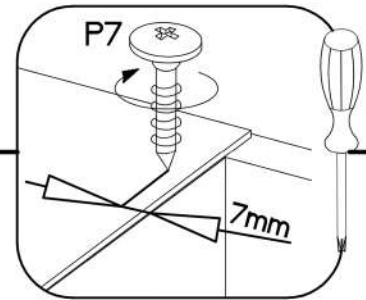
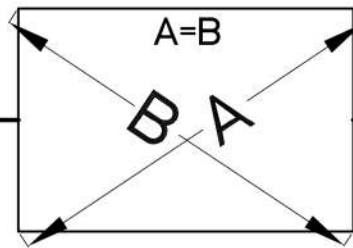
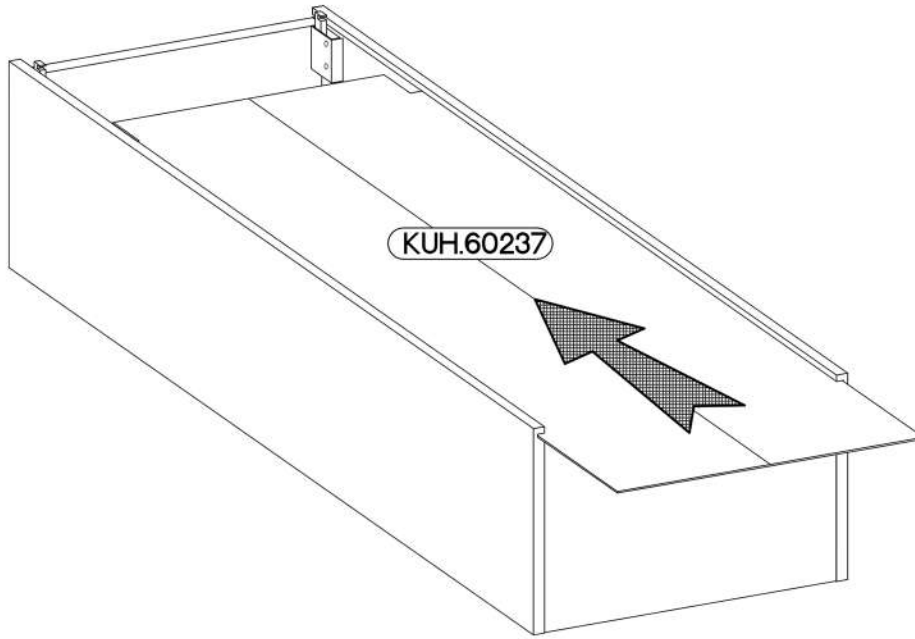
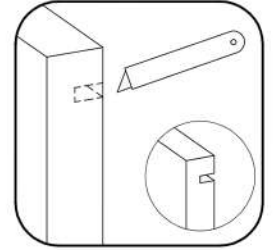
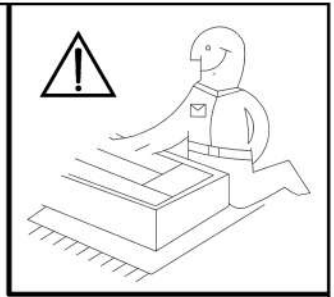

5

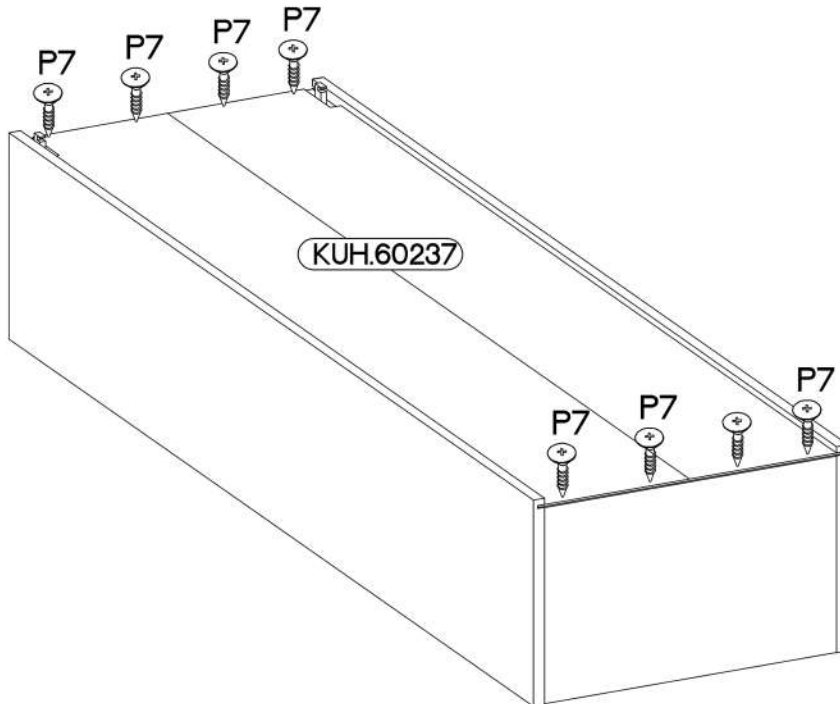
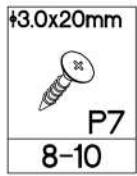

6

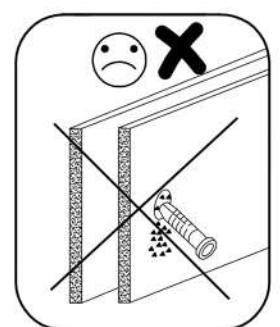
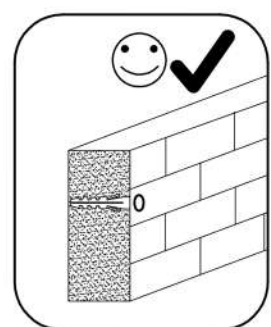
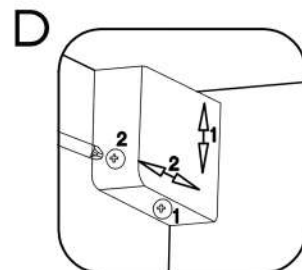
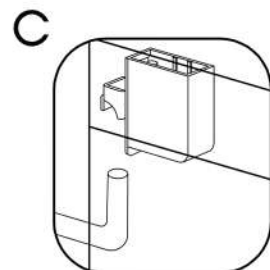
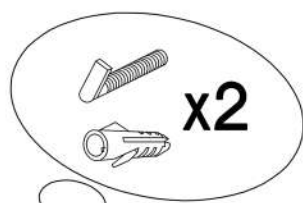
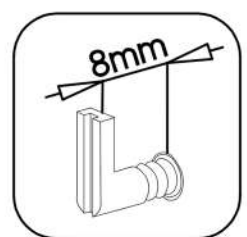
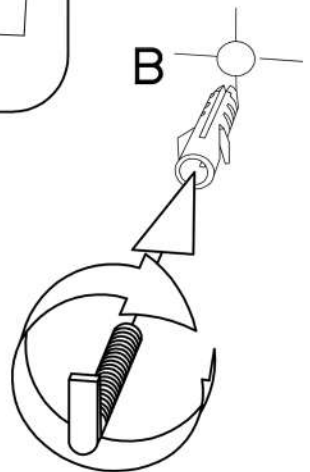
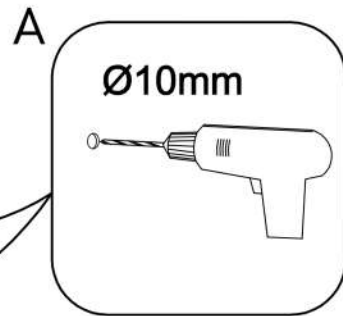
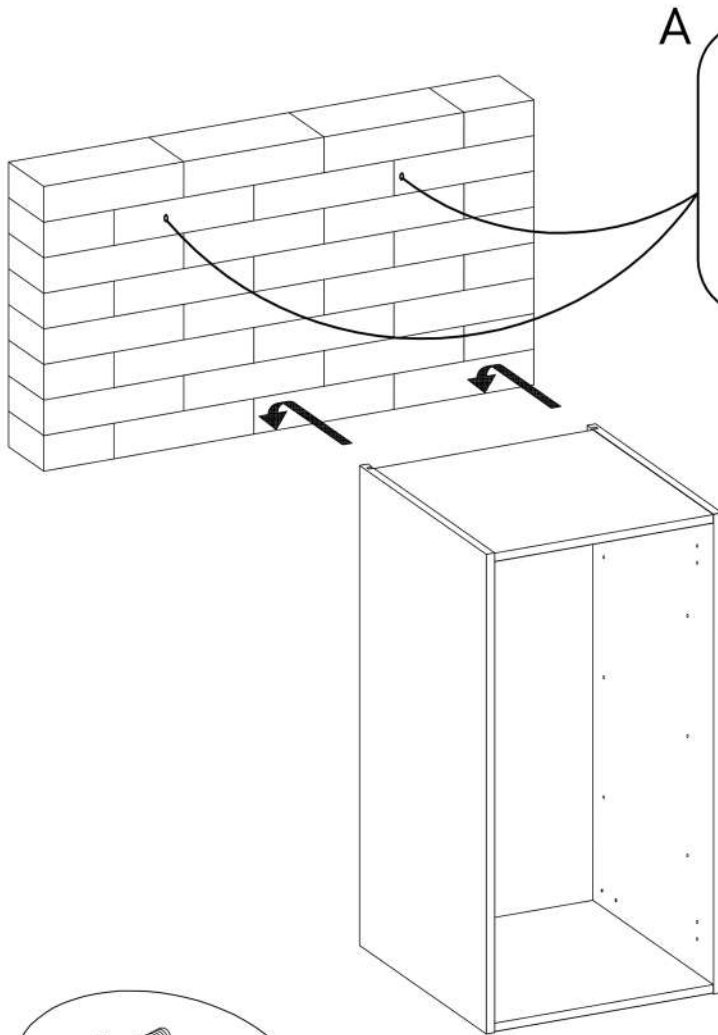
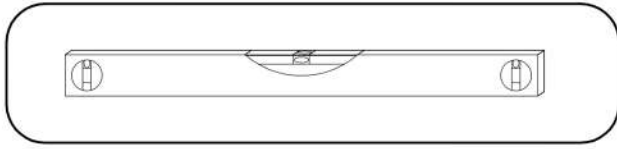

7

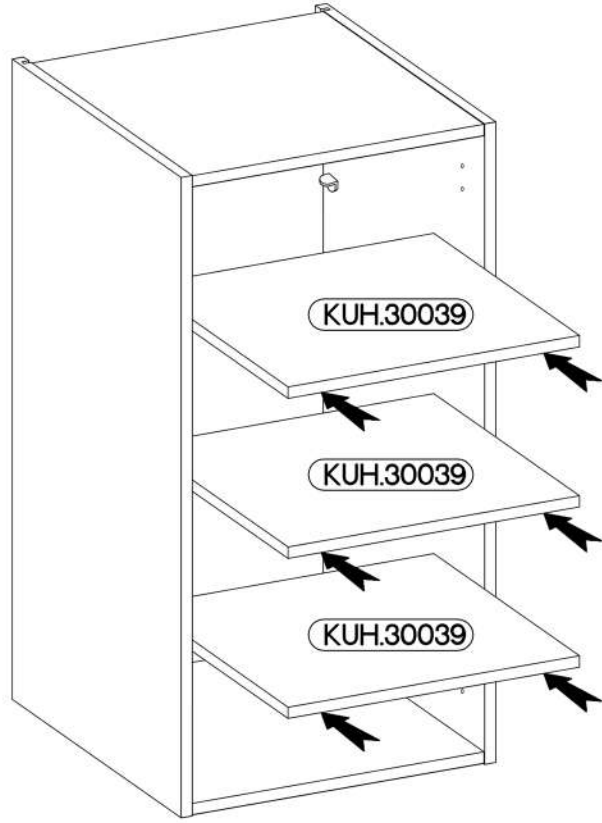
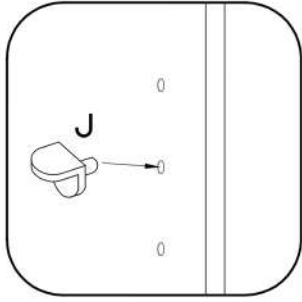
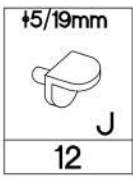

8

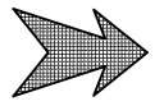
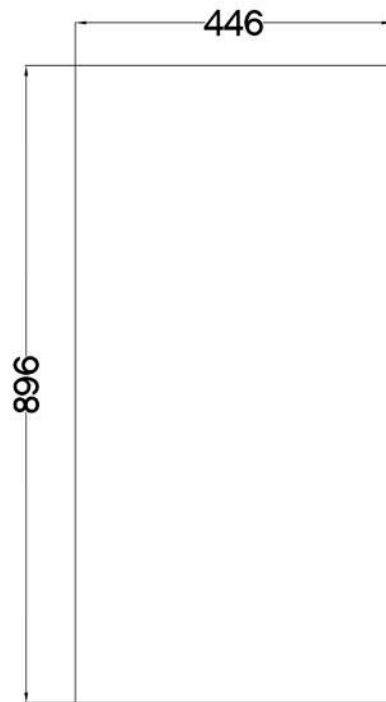

| | | | |
|--|--|------------------|--|
| | | | |
| | | <h1>896x446</h1> | |

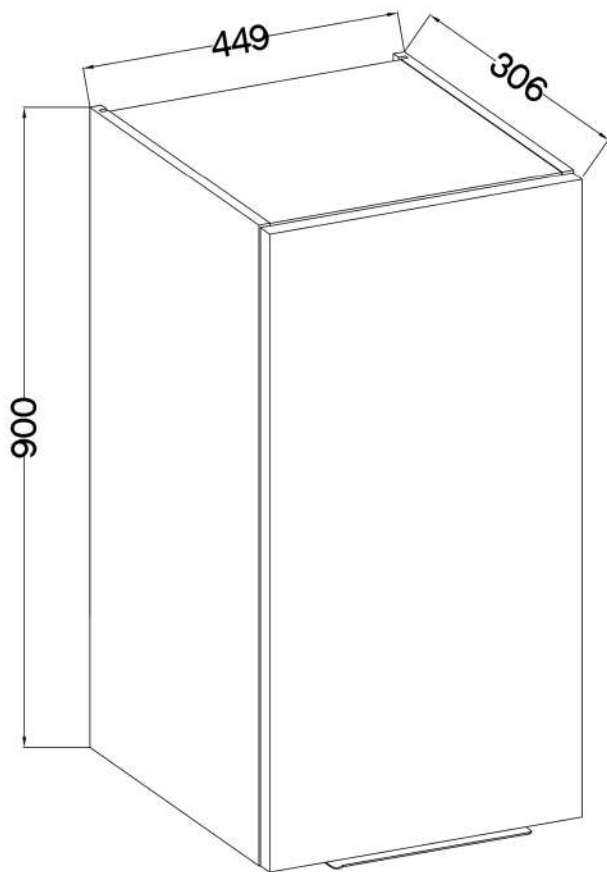

| | |
|---------|--------|
| L=256mm | ±7/2mm |
| | |
| S | J5 |
| 1 | 2 |

| | |
|-----------|------------|
| KUH.71157 | 896x446x16 |
|-----------|------------|

1

| | | |
|-------------------------------------|---|-------------------------------|
| $\pm 35/0\text{mm}$ [CD] HG 2 | $\pm 3.5 \times 13\text{mm}$ P5 4 | $\pm 7/2\text{mm}$ J5 2 |
|-------------------------------------|---|-------------------------------|

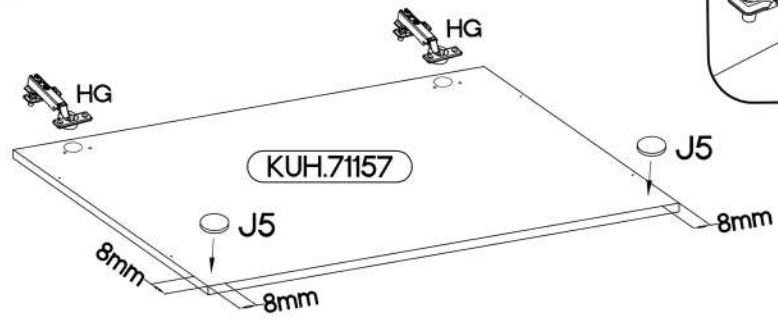
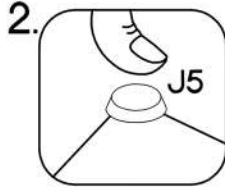
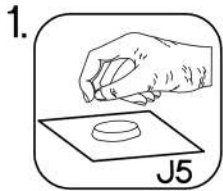
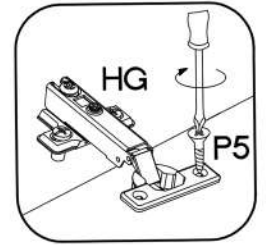

2

| |
|-------------------|
| L=256mm S 1 |
|-------------------|

