

FRISBO 50 G-108 1F

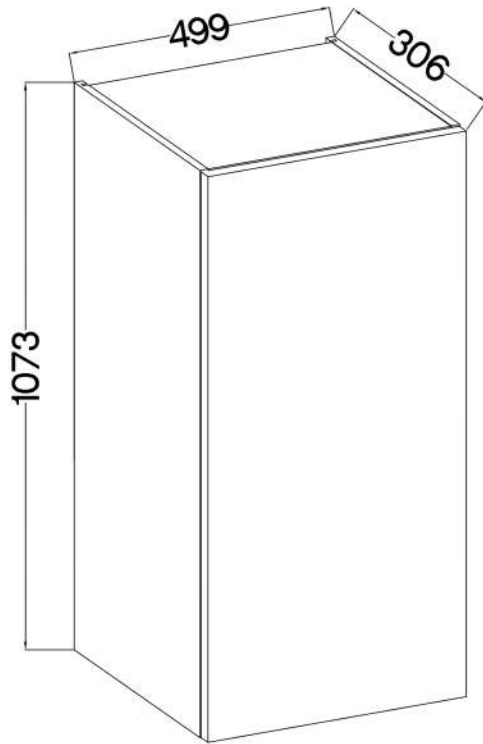

max. 5kg
 KUH.30001
 KUH.40001

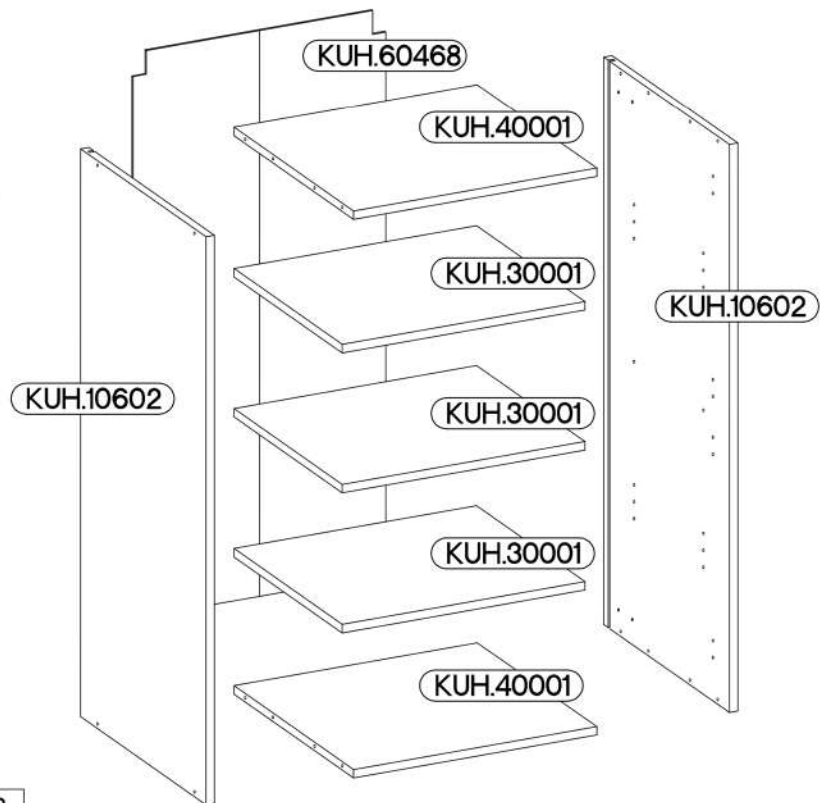

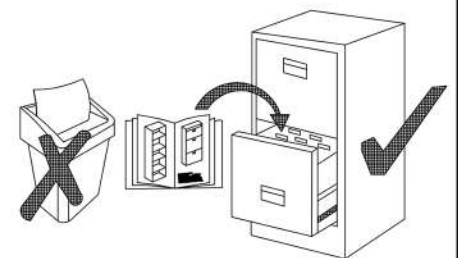

KUH.10602 x2	1073x290x16
KUH.30001 x3	466x250x16
KUH.40001 x2	467x276x16
KUH.60468	1070x485x2,5

A 8	B 8	E1 8	HG 3			
J3 12	K 2	O 1	P5 6	P7 8-10	P8 4	
†8x30mm	6,4 x 50mm		†35/0mm			
†5/16mm			†3.5x13mm	†3.0x20mm	†4.0x30mm	



1

$\pm 8 \times 30 \text{mm}$  A 8	$\pm 4.0 \times 30 \text{mm}$  P8 4	 K 2
--	---	---

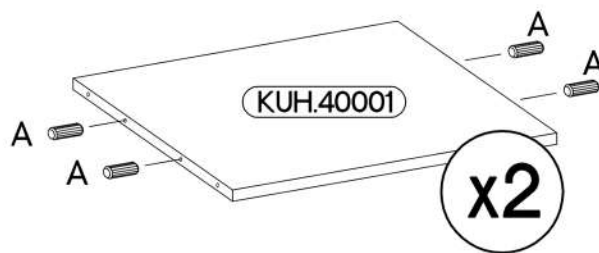
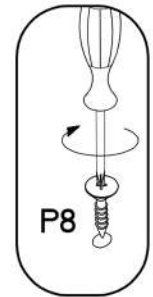
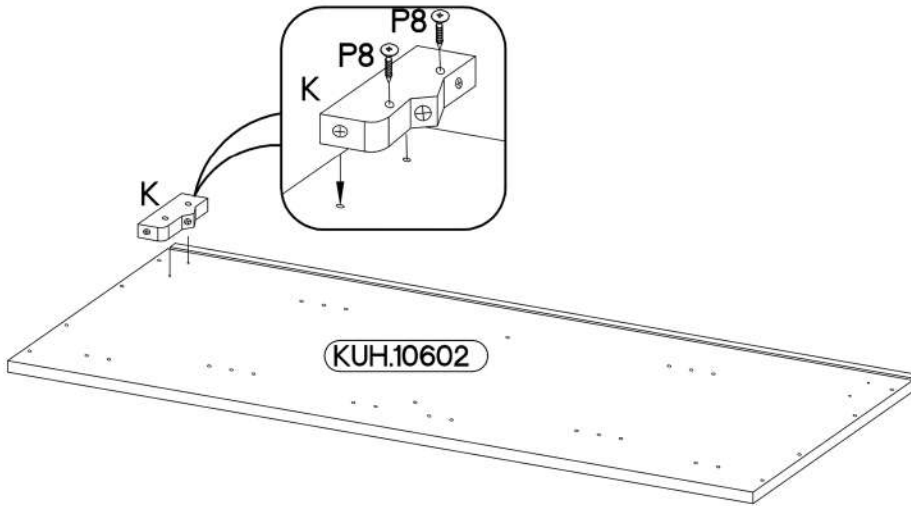
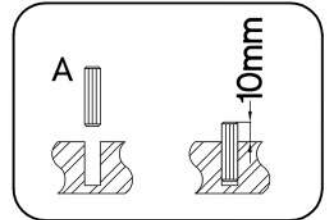
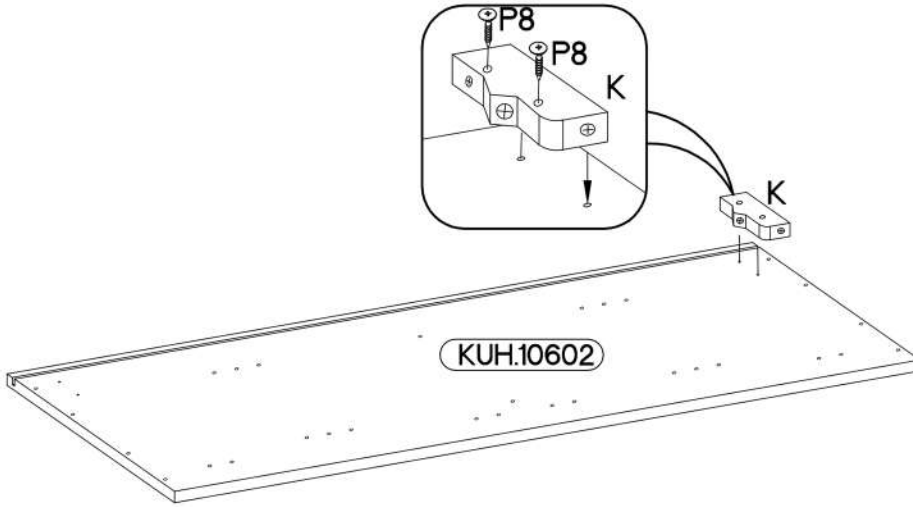
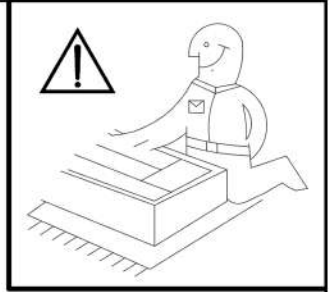

2

6,4 x 50mm

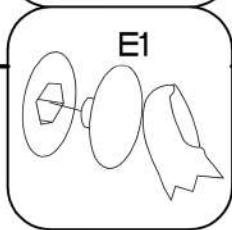
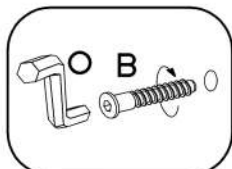
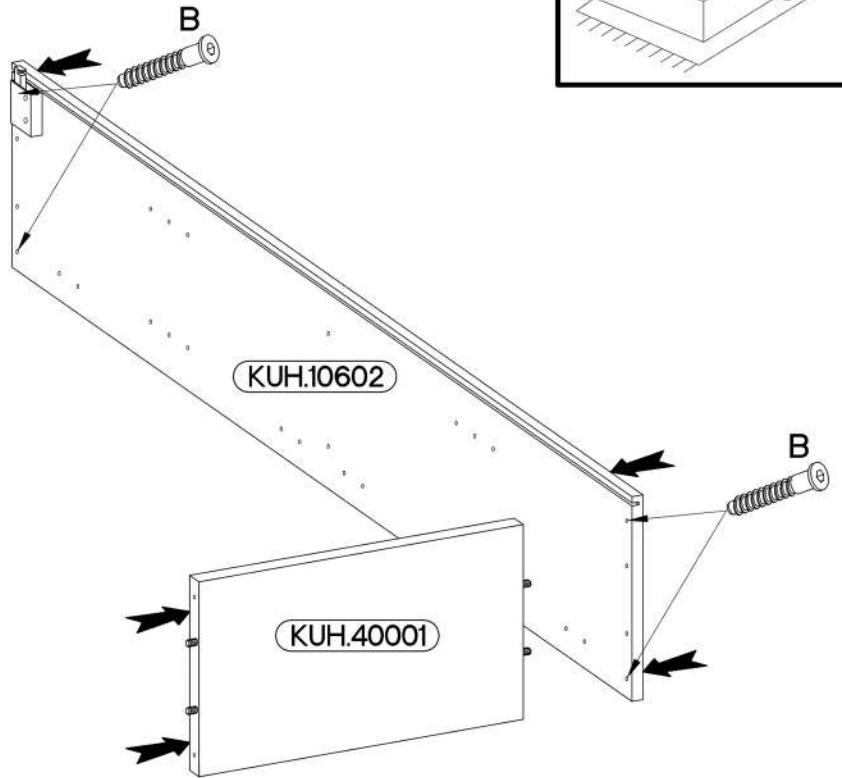
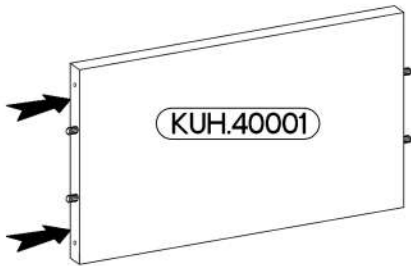
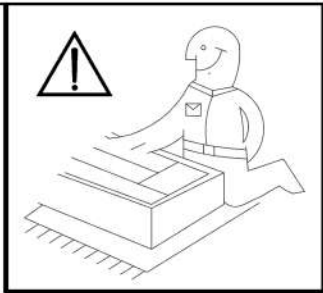
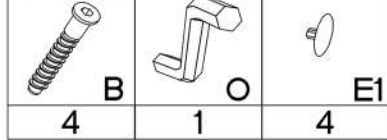

3

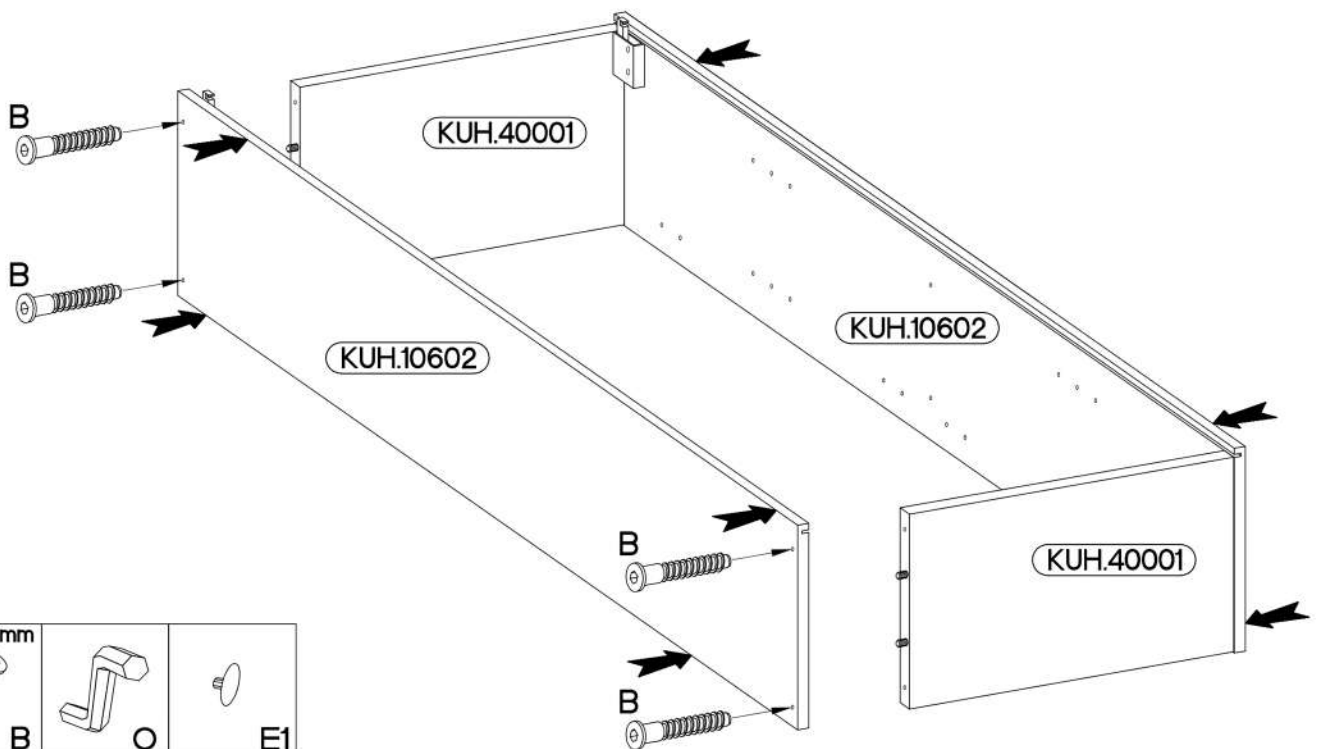

6,4 x 50mm

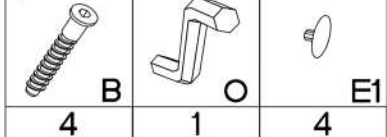

4

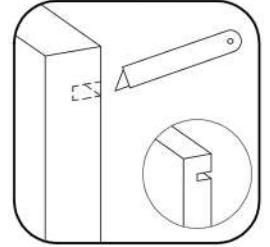
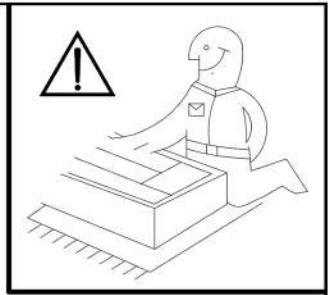
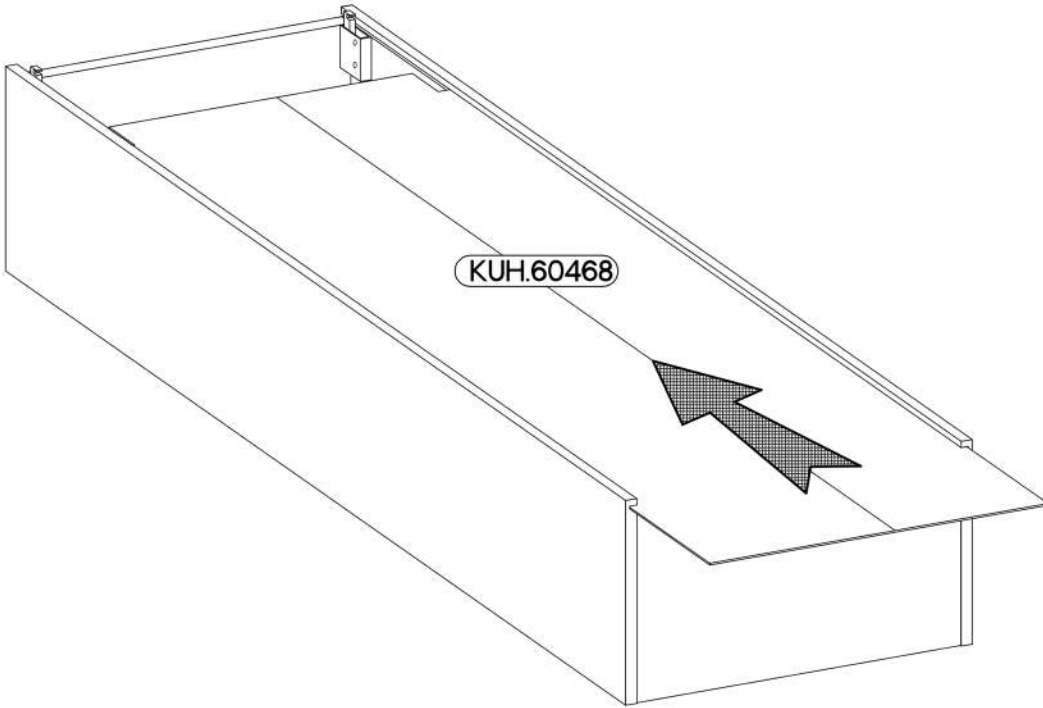

5

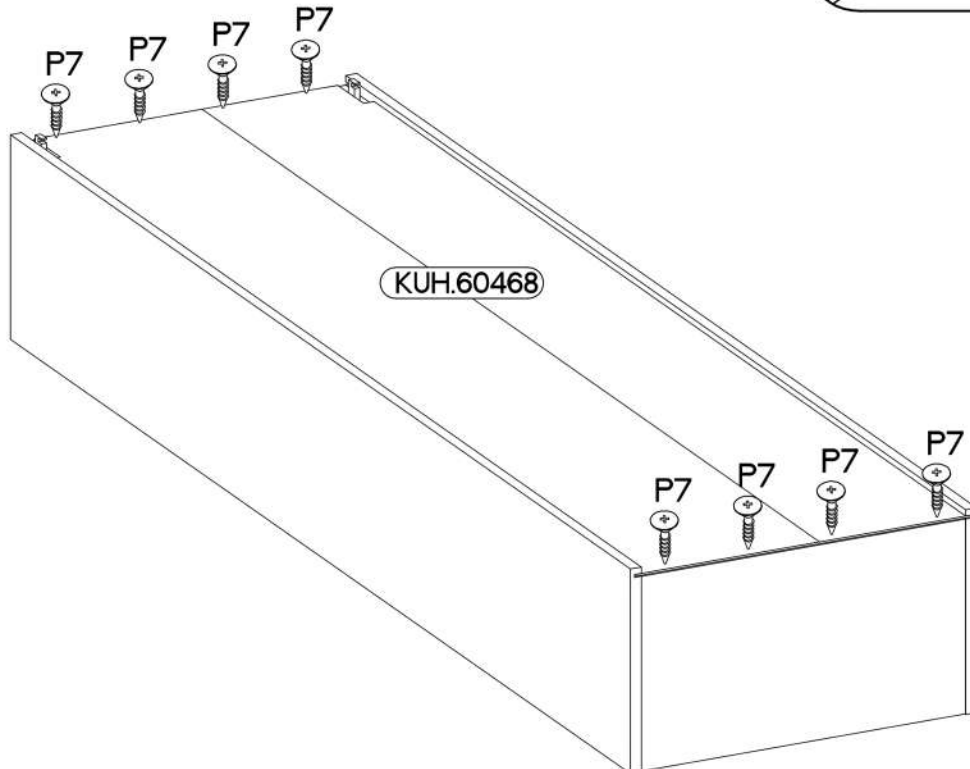
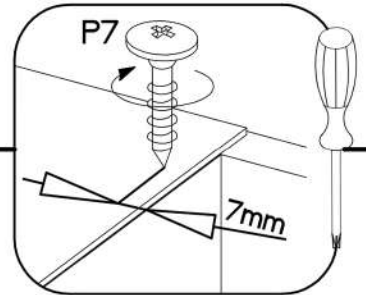
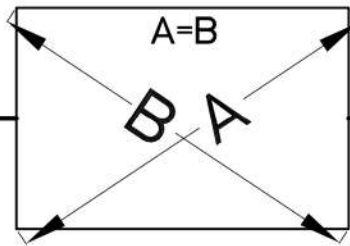

6

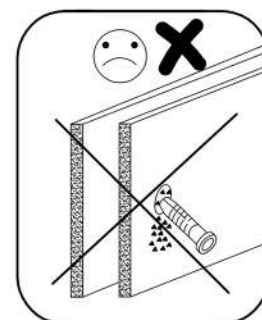
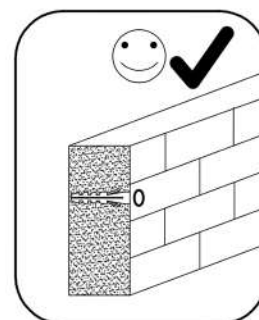
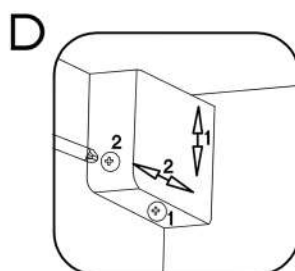
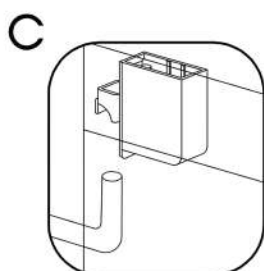
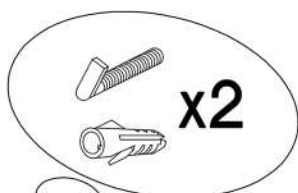
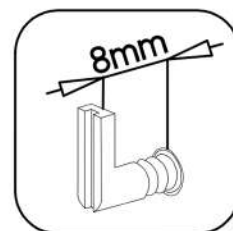
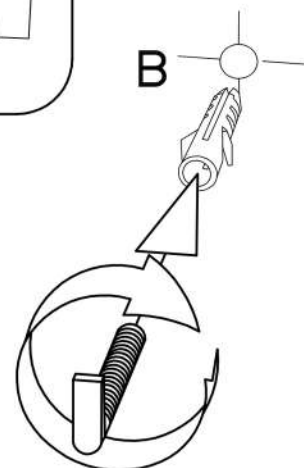
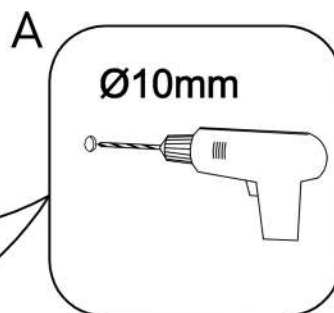
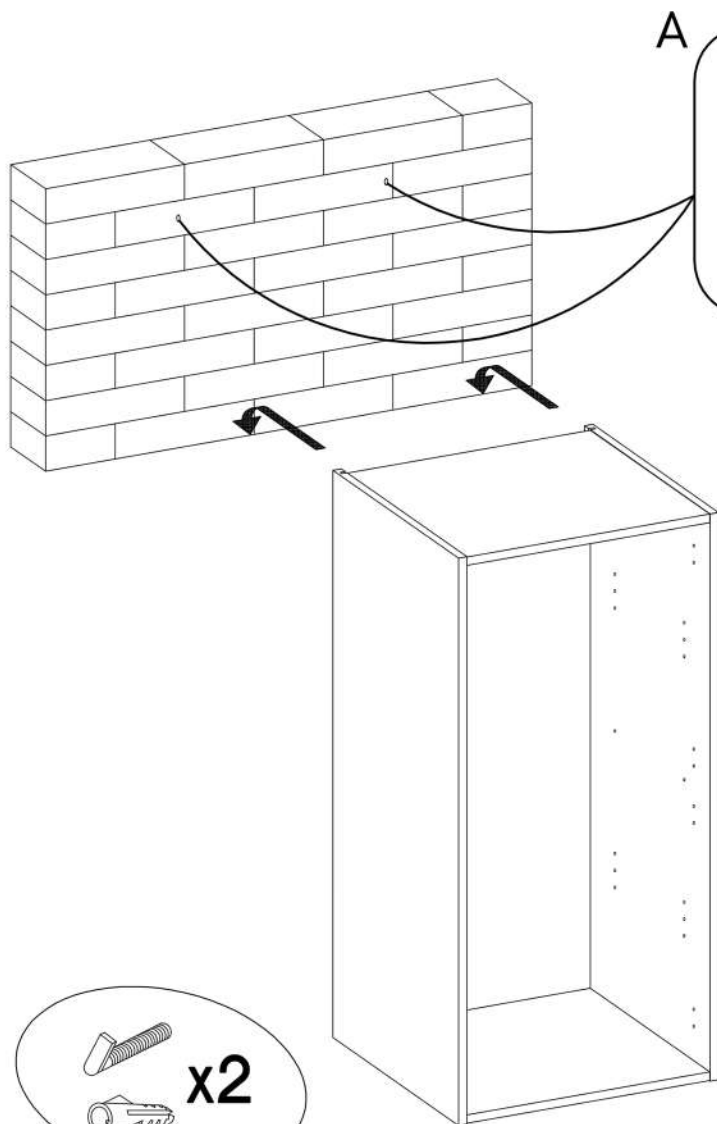
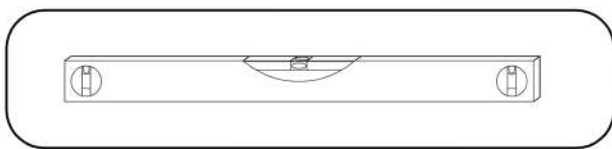

7

+5/16mm
J3
12

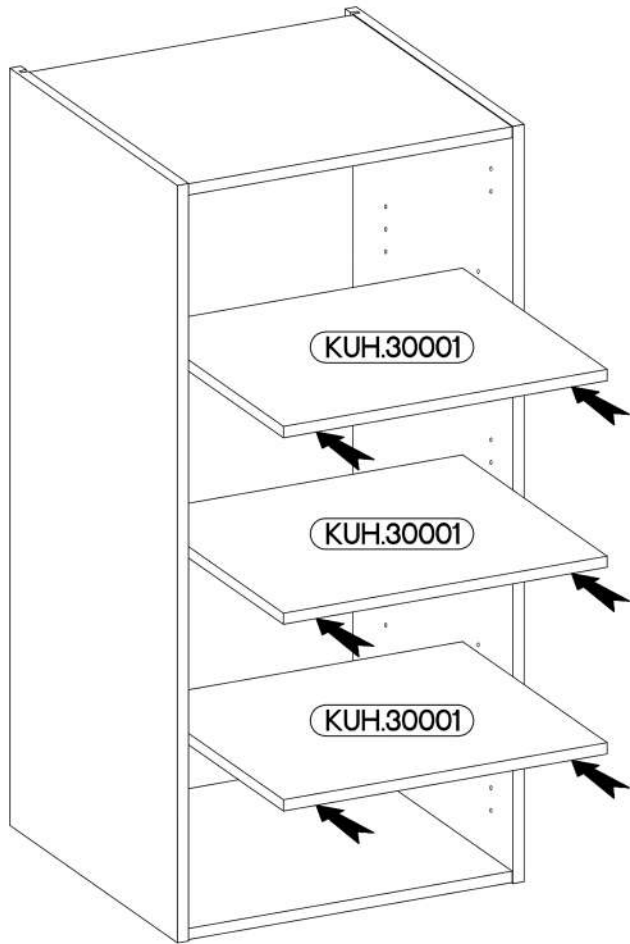
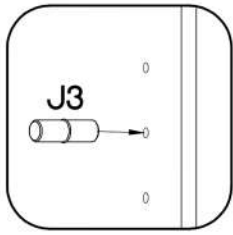

8

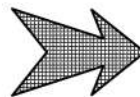
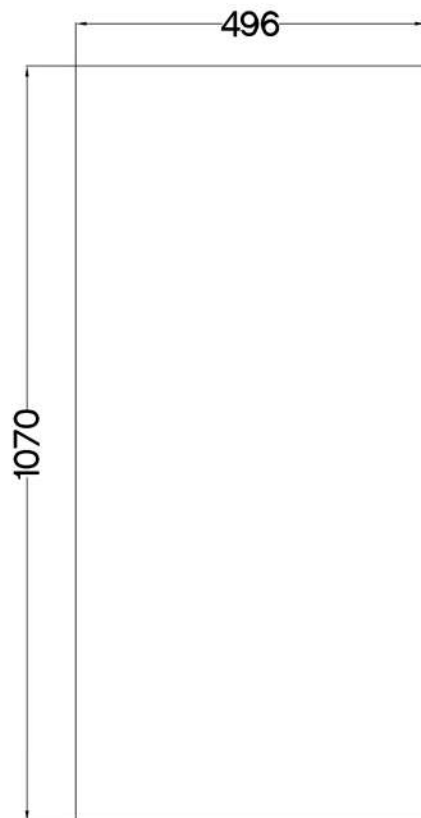

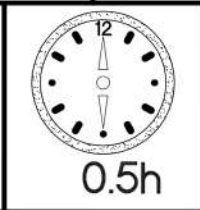
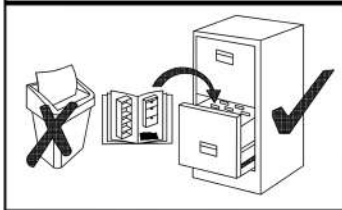
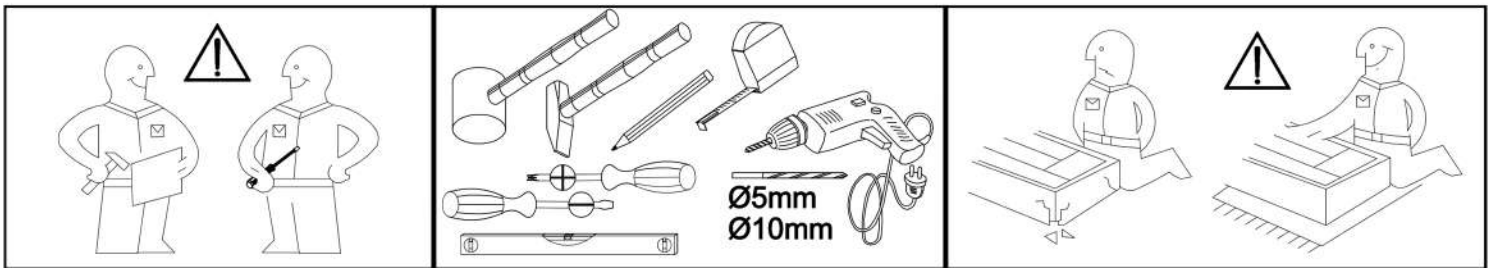

1070x496

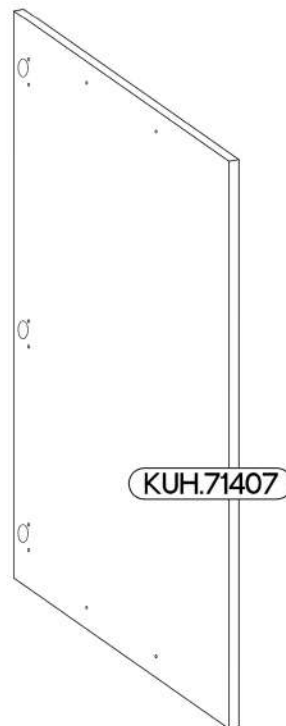
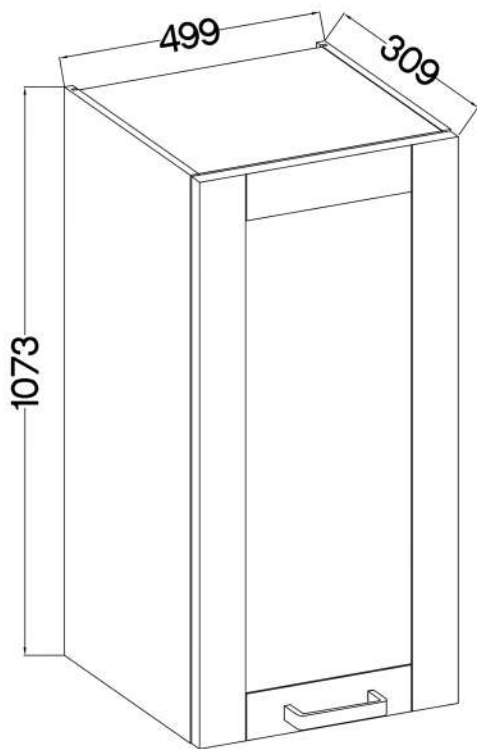
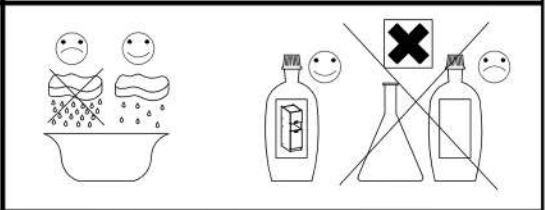

L=160mm	M4x27mm
S	U8
1	2

KUH.71407	1070x496x19
-----------	-------------

1

L



R

KUH.71407

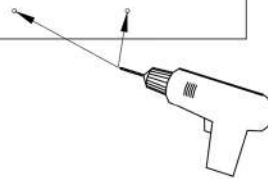
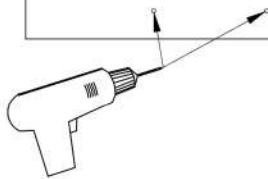
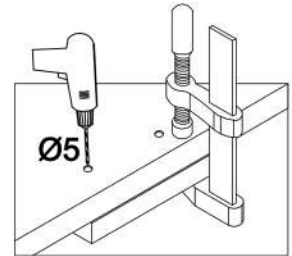
KUH.71407



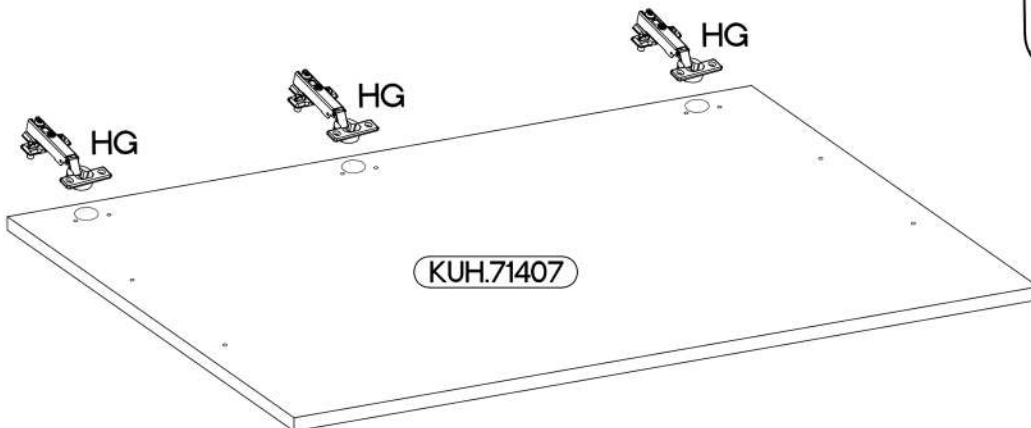
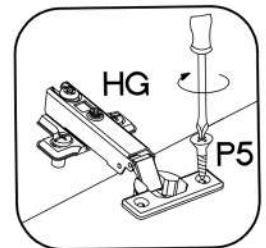

2

 HG 3	 P5 6
--	--



3

L=160mm	M4x27mm
	
S	U8
1	2

