

FRISBO 50 G-90 1F

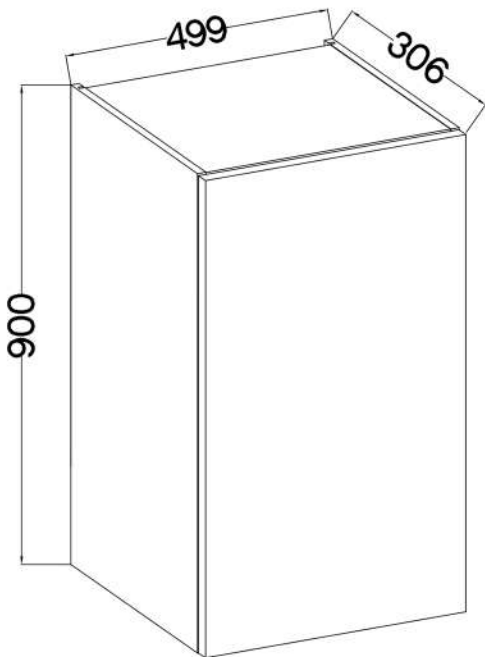

KUH.30001
KUH.40001

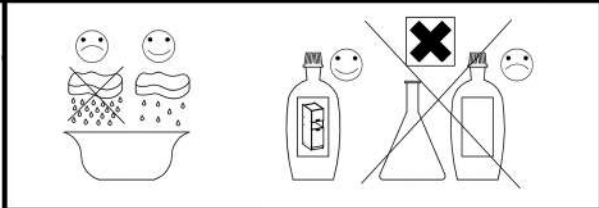

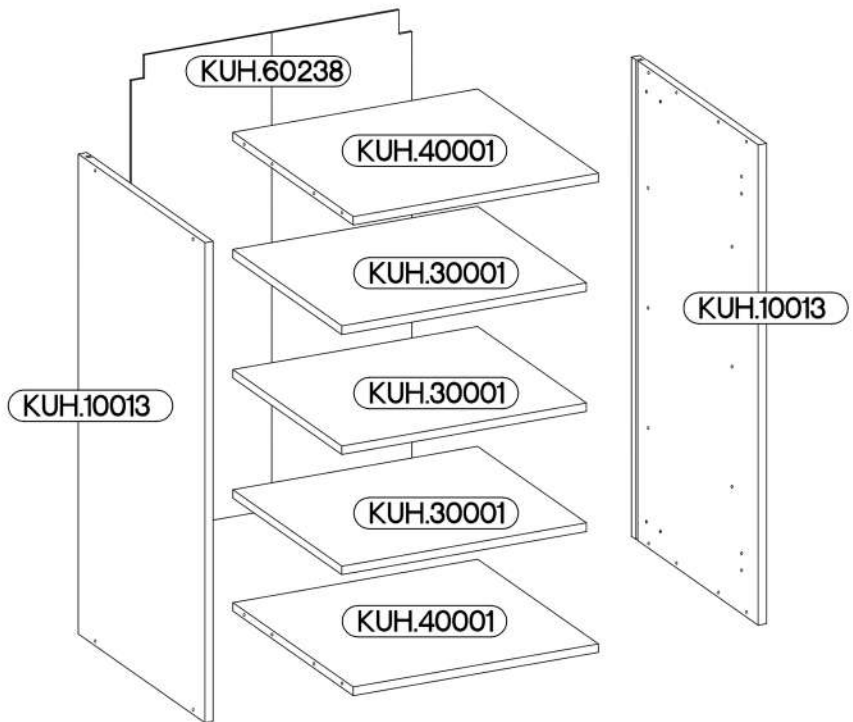
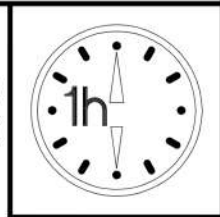

KUH.10013 x2	900x290x16
KUH.30001 x3	466x250x16
KUH.40001 x2	467x276x16
KUH.60238	896x485x2,5

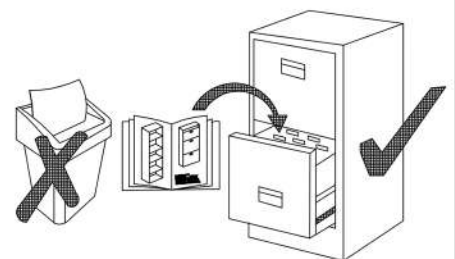
 A 8	 B 8	 E1 8	 HG 2	 P5 4	 P7 8-10	 P8 4
 J 12	 K 2	 O 1	 P5 4	 P7 8-10	 P8 4	



1

 +8x30mm A 8	 +4.0x30mm P8 4	 K 2
--	---	---

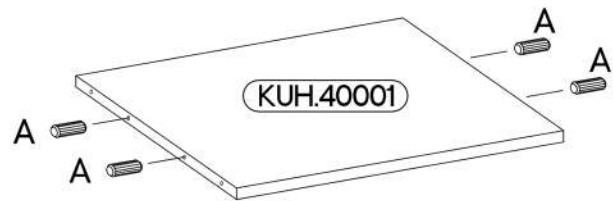
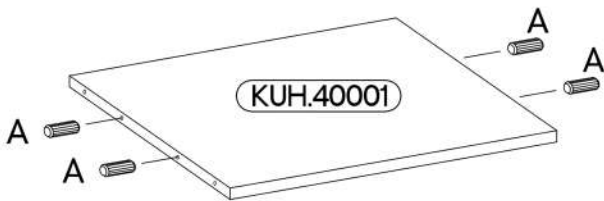
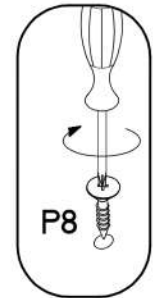
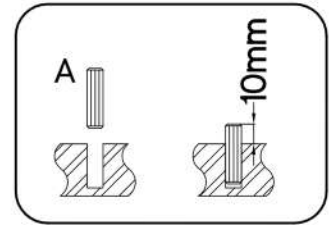
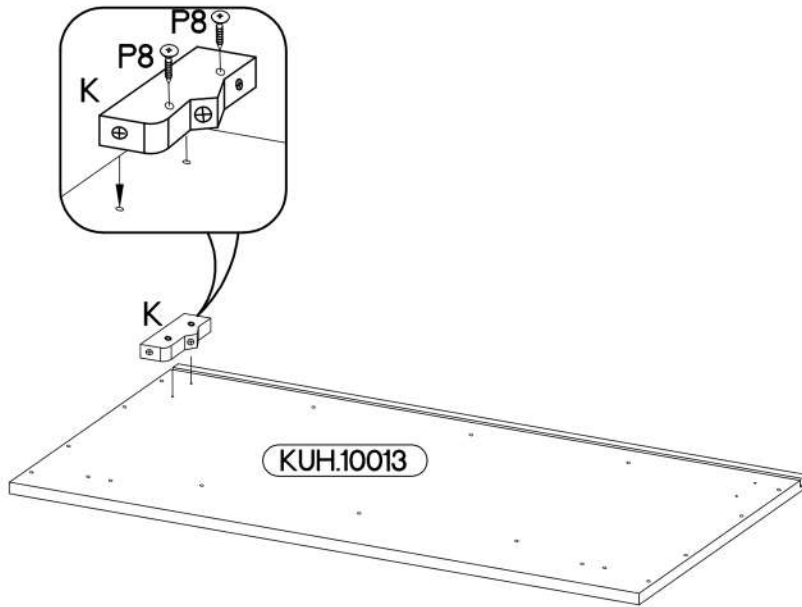
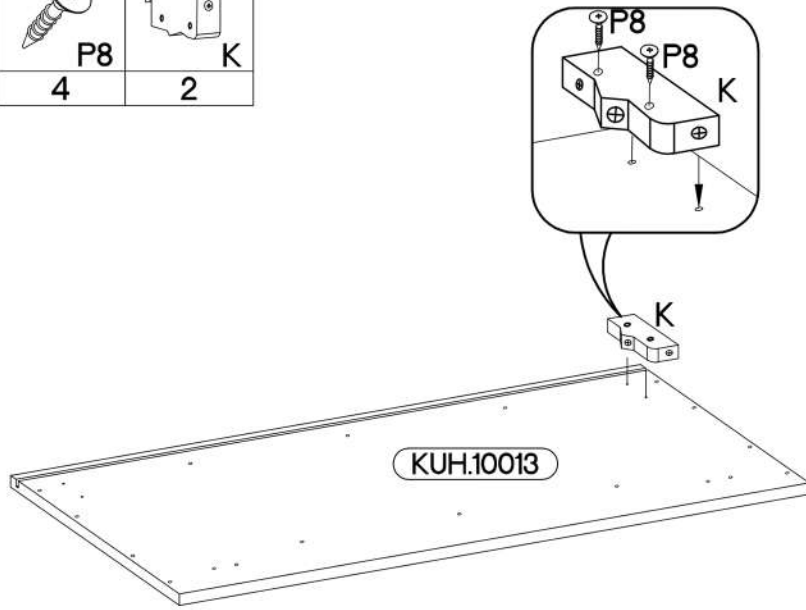

2

6,4 x 50mm

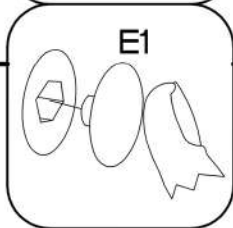
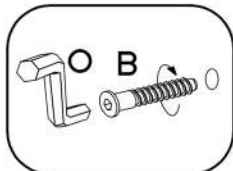
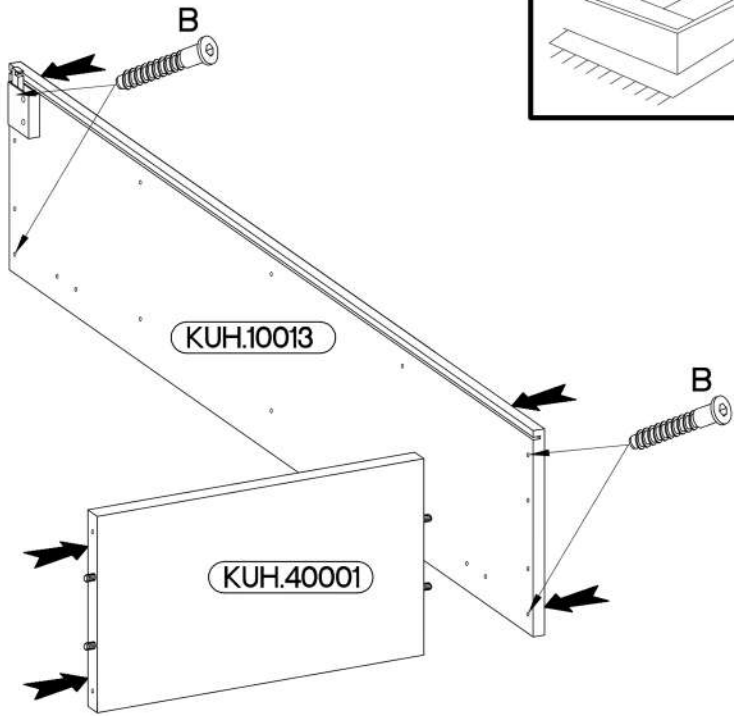
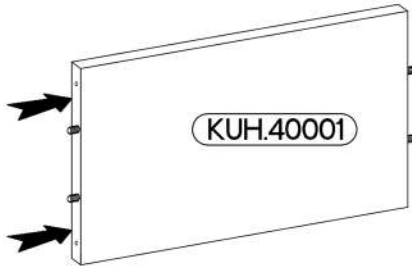
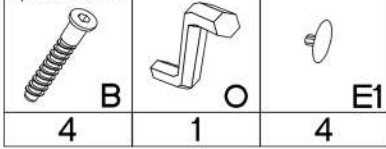

3

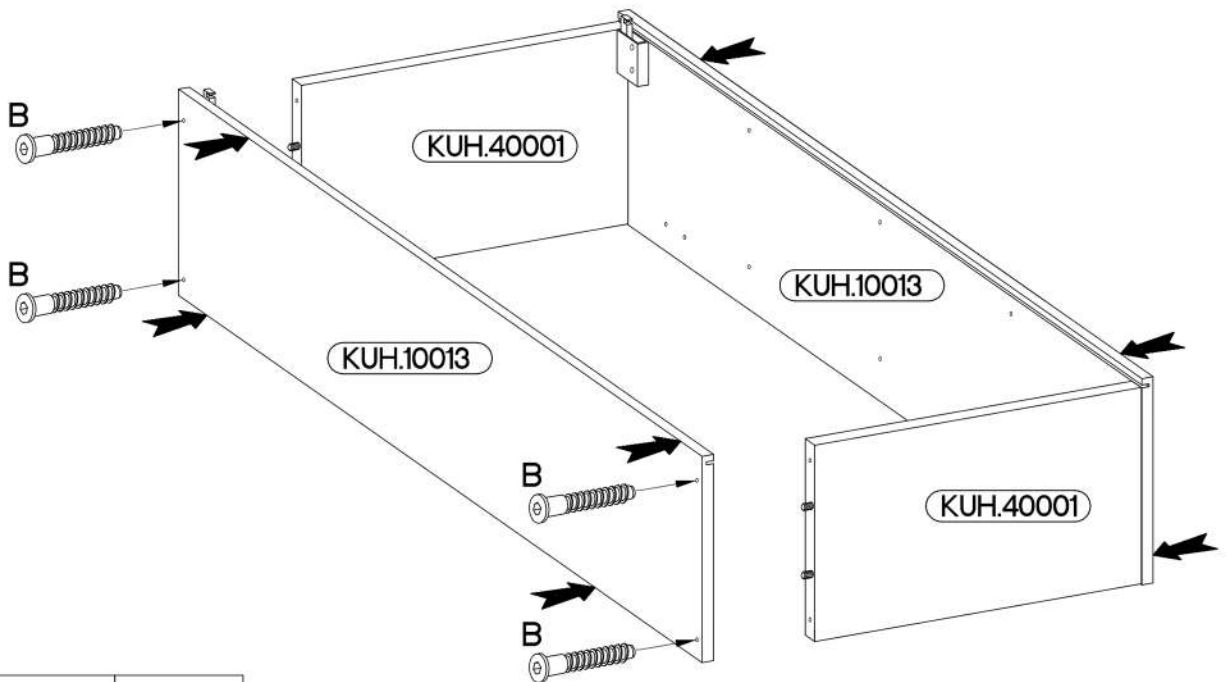

6,4 x 50mm

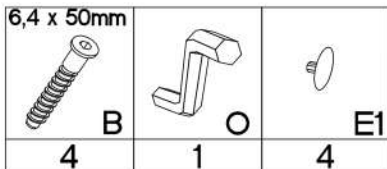

4

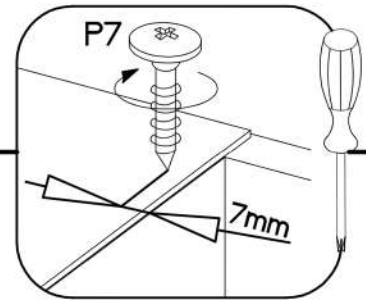
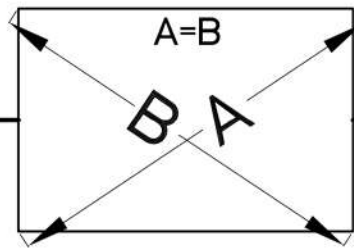
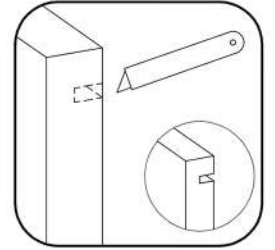
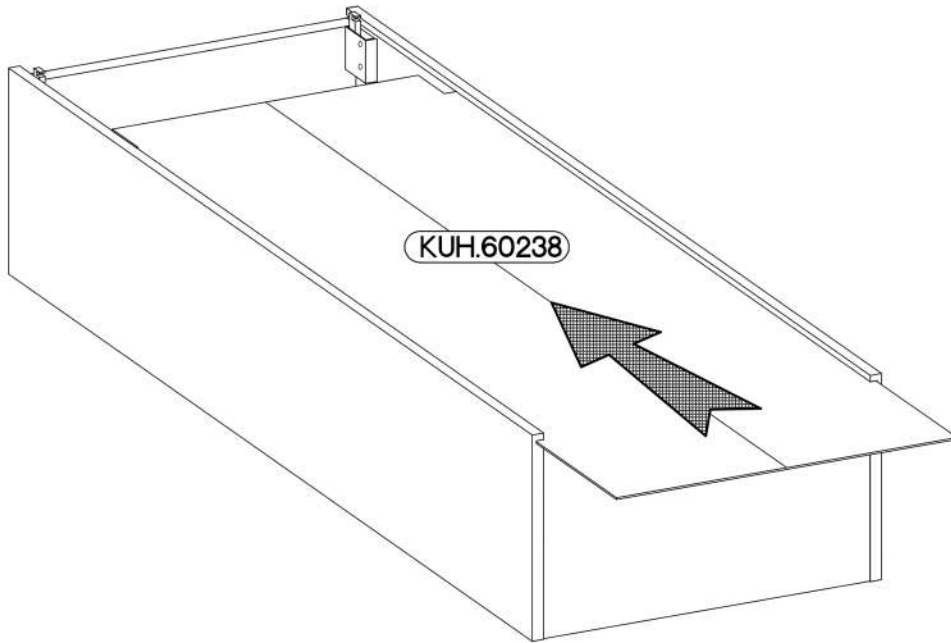

5

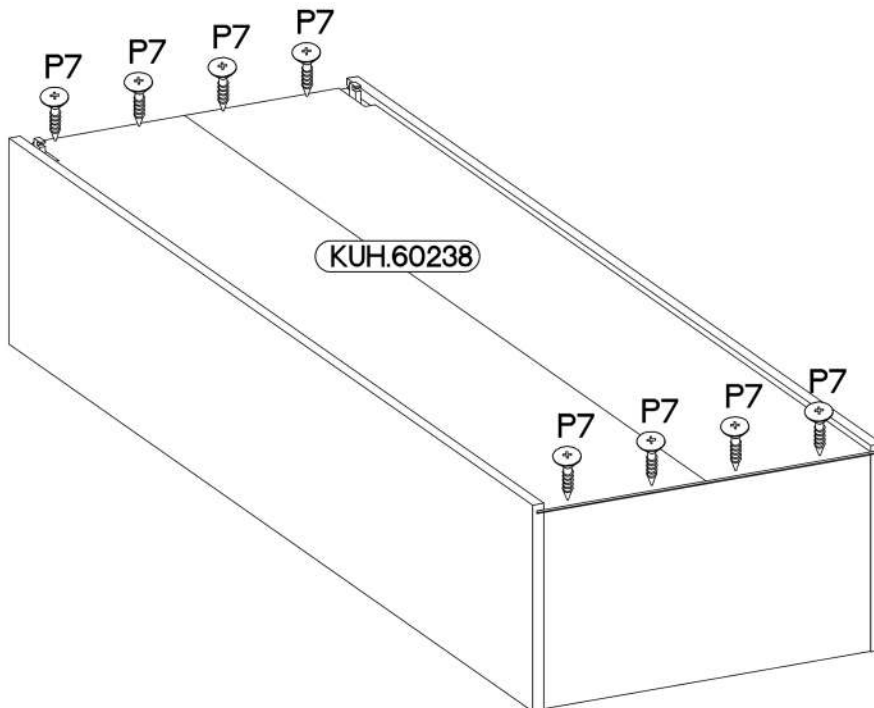

6

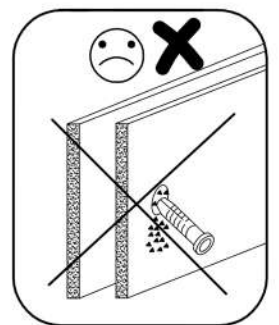
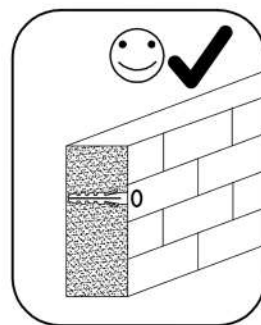
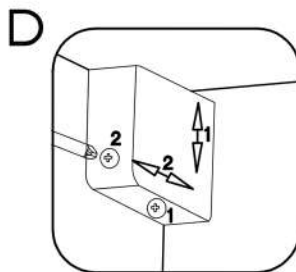
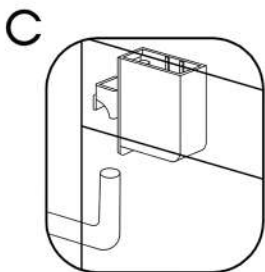
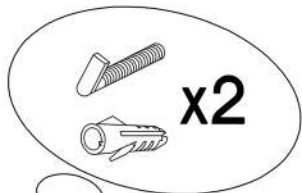
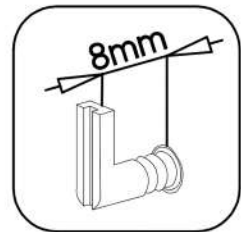
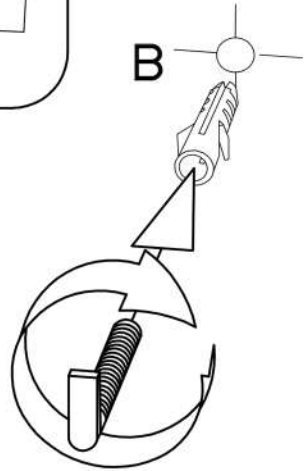
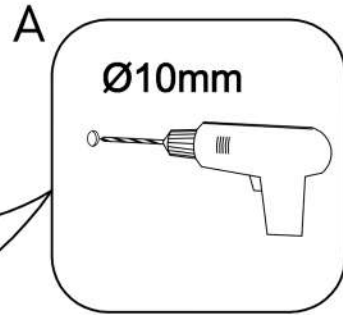
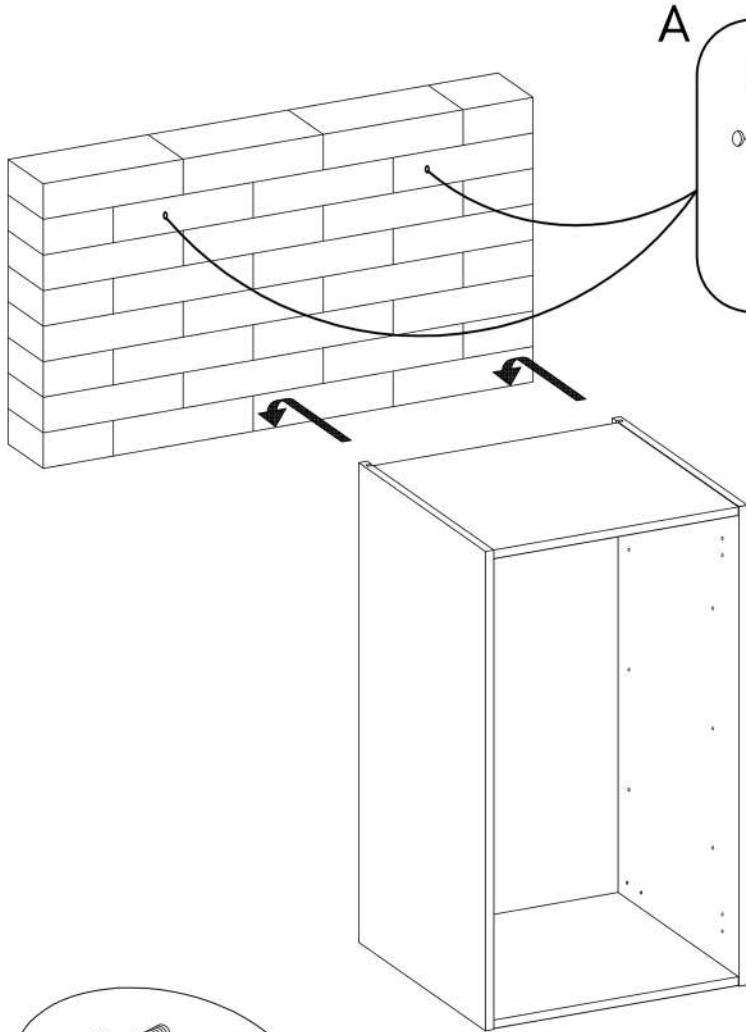
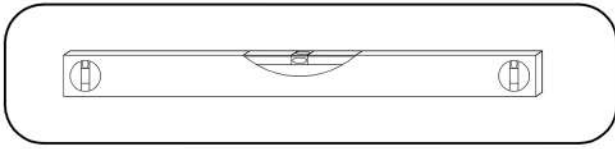

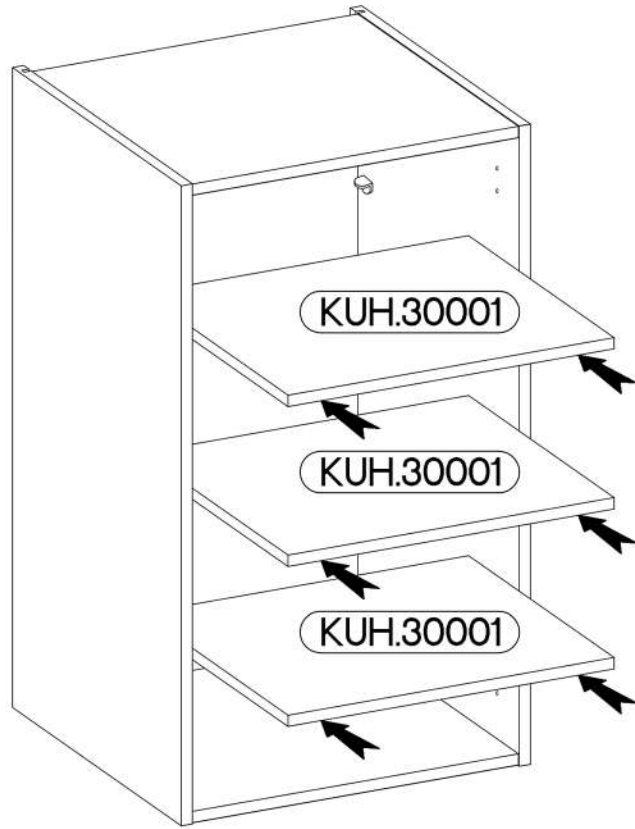
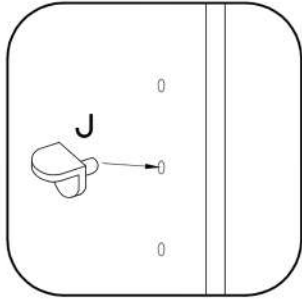
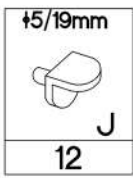

7

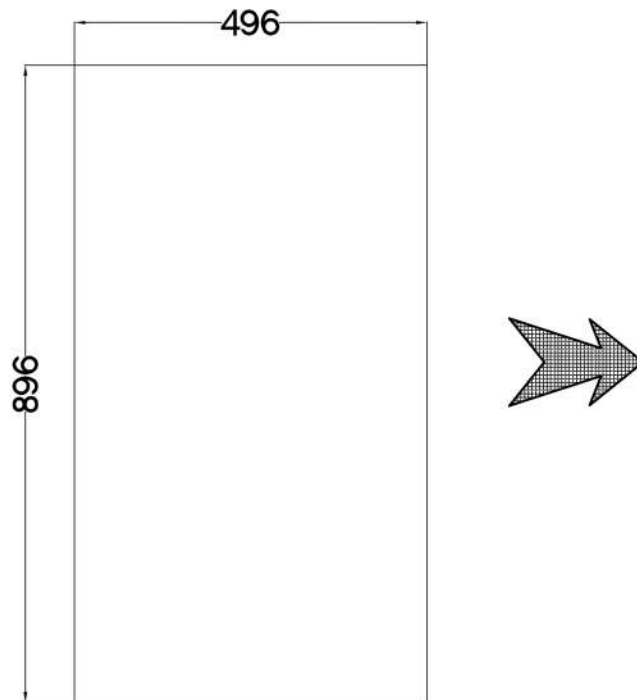

8

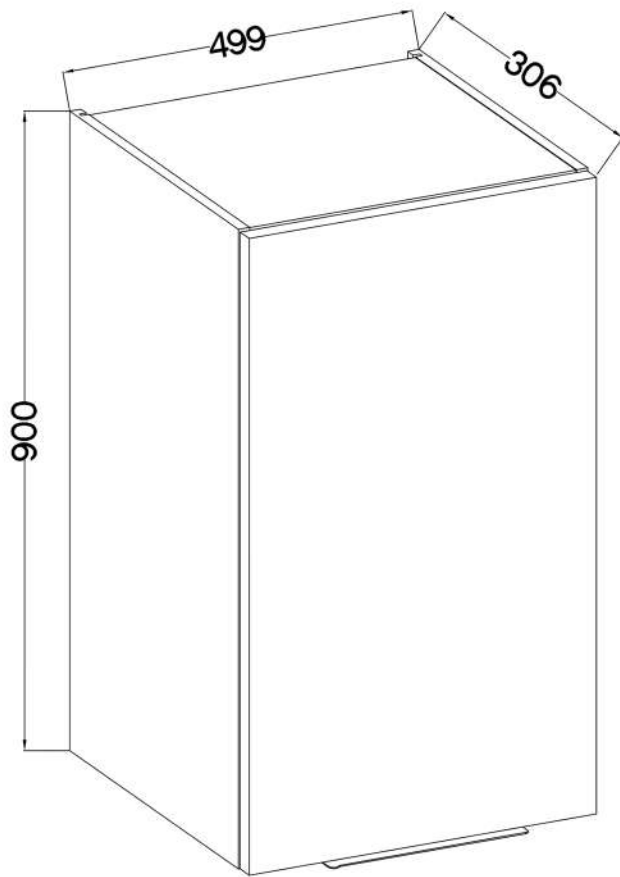
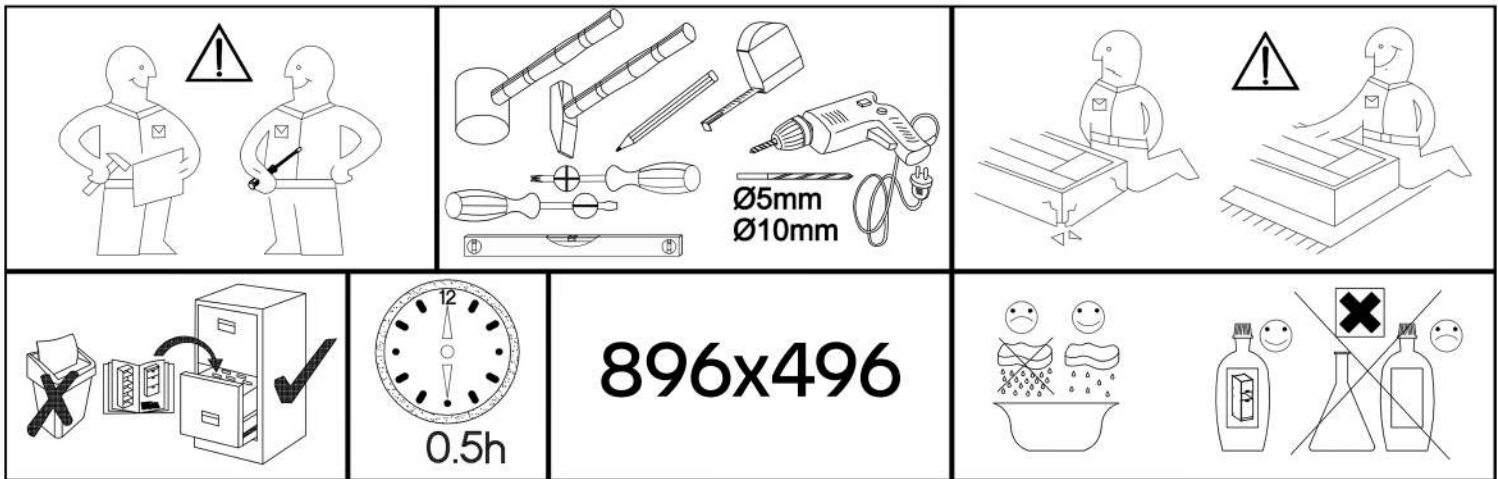





L=256mm	$\pm 7/2\text{mm}$
	
S	J5
1	2

KUH.71158	896x496x16
-----------	------------

1

 [CD] HG 2	 P5 4	 J5 2
--	---	---

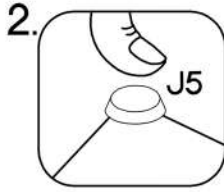
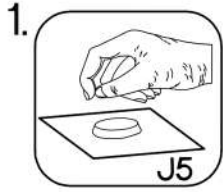
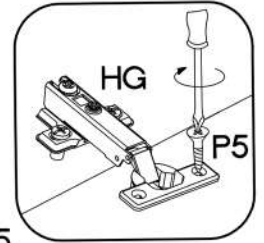
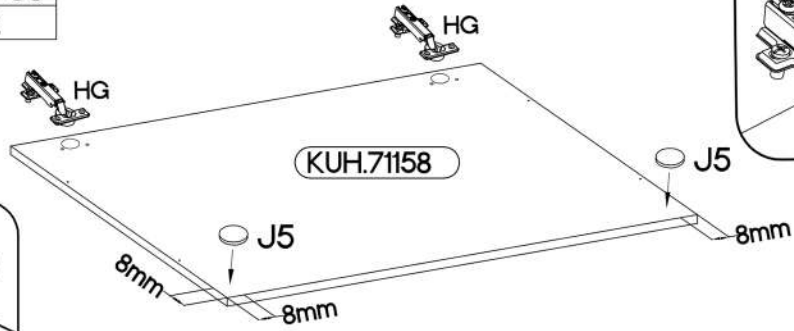

2

 L=256mm S 1
--

