

FRISBO 50 G-72 1F

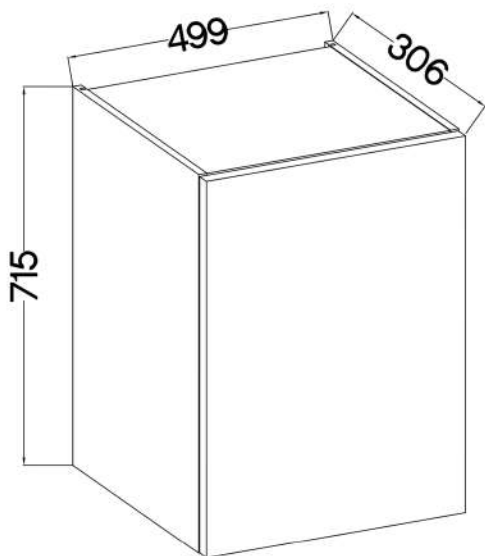

KUH.30001
KUH.40001

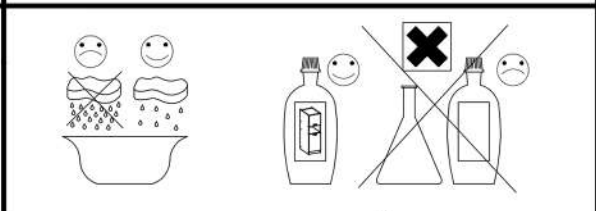

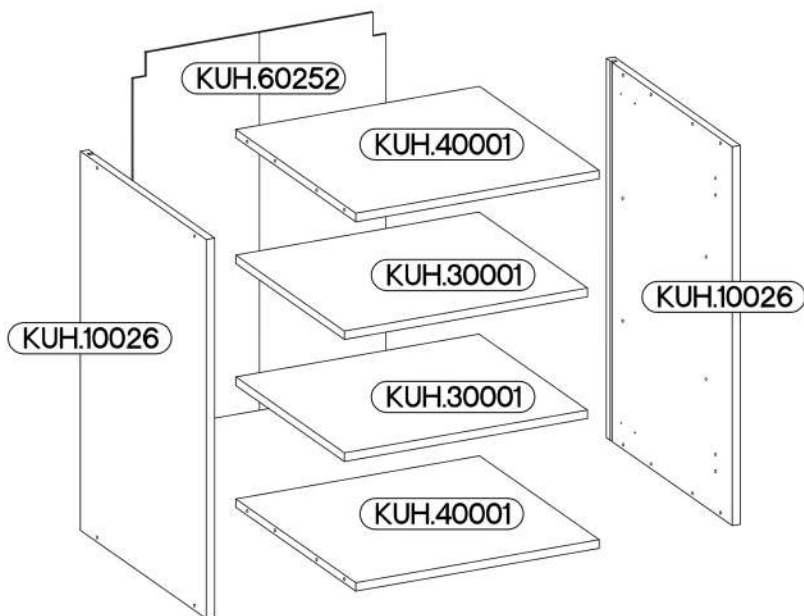

KUH.10026 x2	715x290x16
KUH.30001 x2	466x250x16
KUH.40001 x2	467x276x16
KUH.60252	713x485x2,5

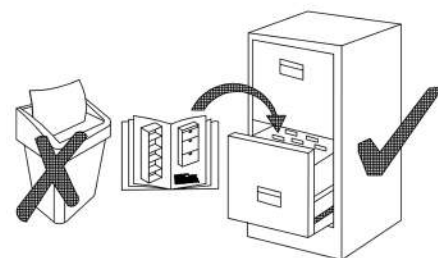
 A 8	 B 8	 E1 8	 HG 2	 J 8	 K 2	 O 1	 P5 4	 P7 8-10	 P8 4
------------	------------	-------------	-------------	------------	------------	------------	-------------	----------------	-------------



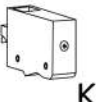

1

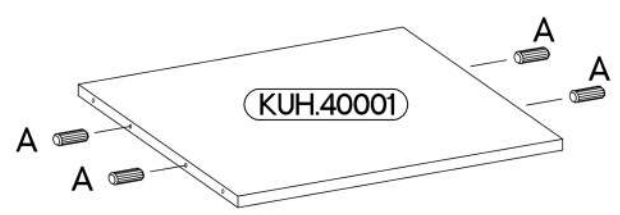
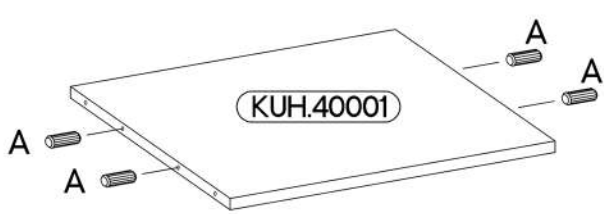
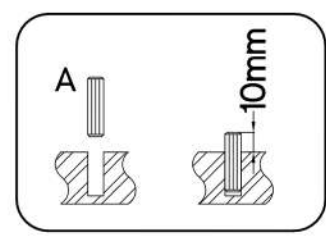
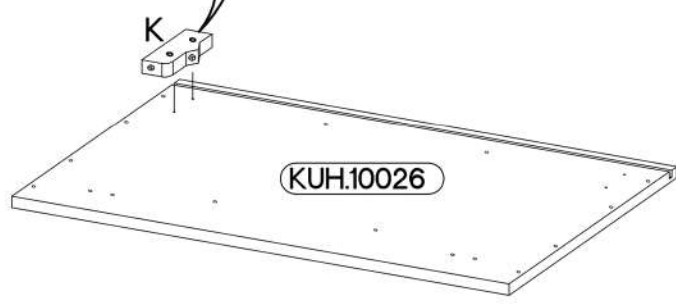
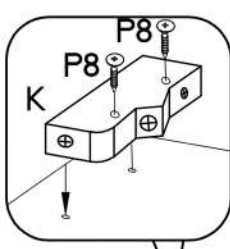
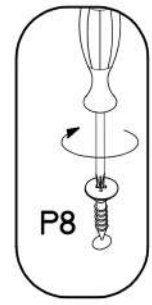
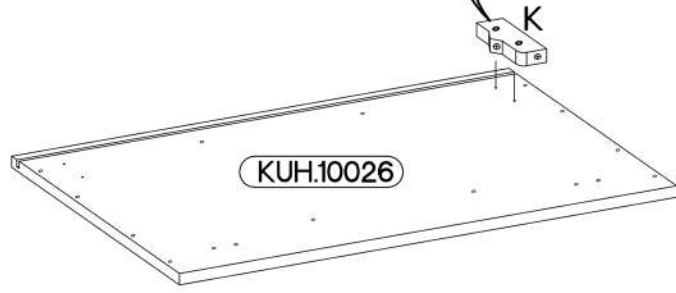
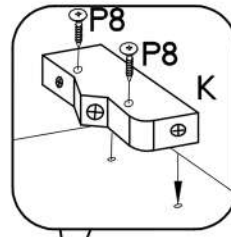
$\pm 8 \times 30 \text{mm}$  A 8	$\pm 4.0 \times 30 \text{mm}$  P8 4	 K 2
--	---	---





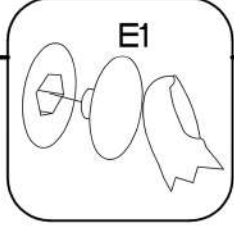
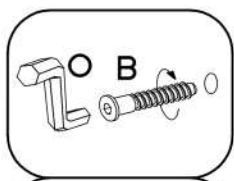
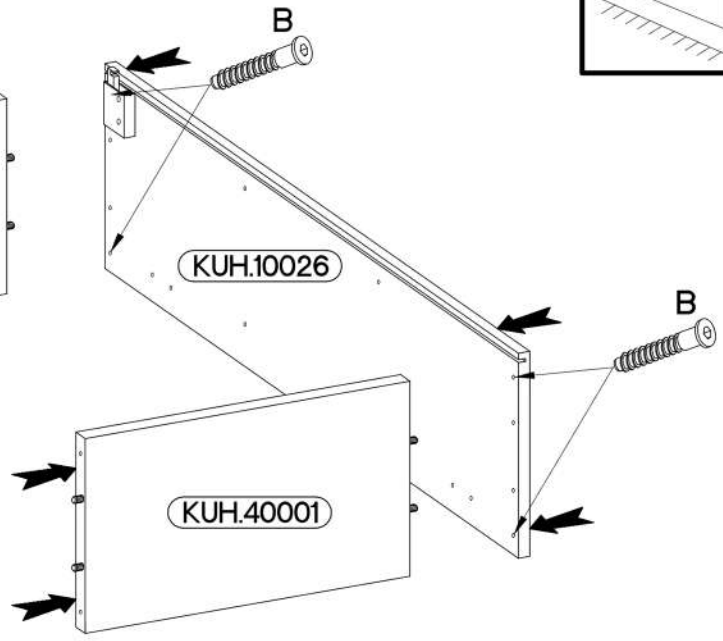
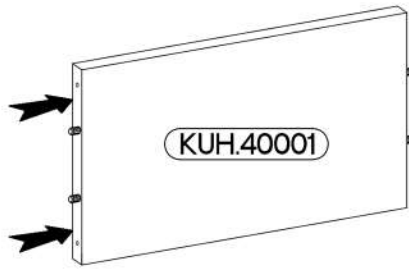

2

6,4 x 50mm		
		
B	O	E1
4	1	4

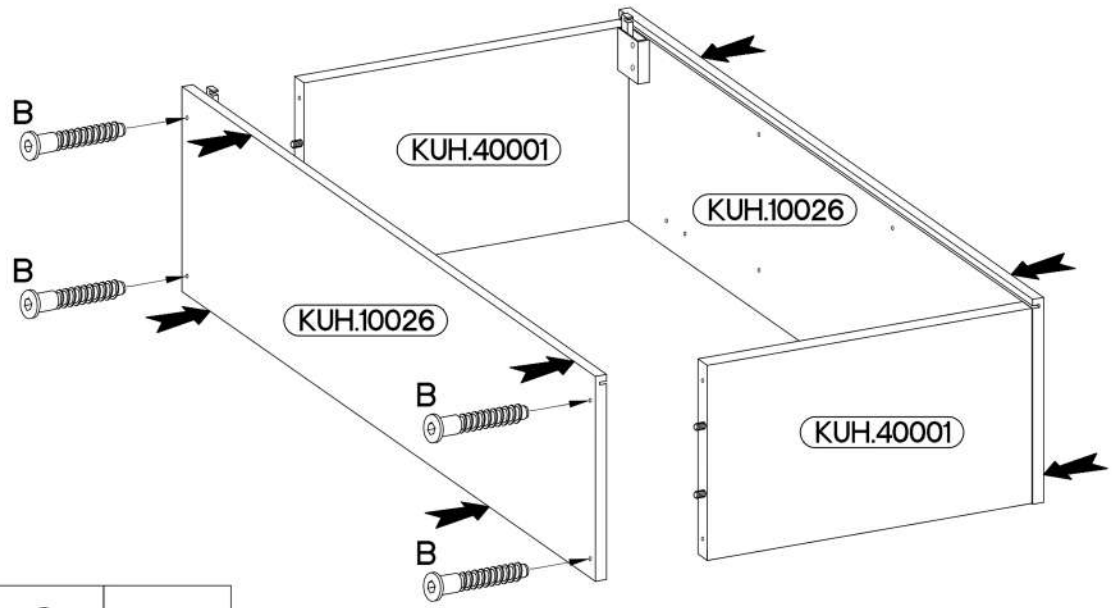

3



6,4 x 50mm		
		
B	O	E1
4	1	4

4

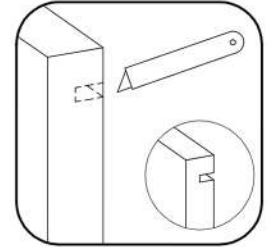
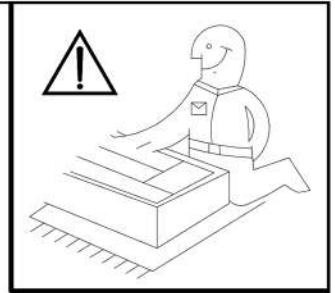
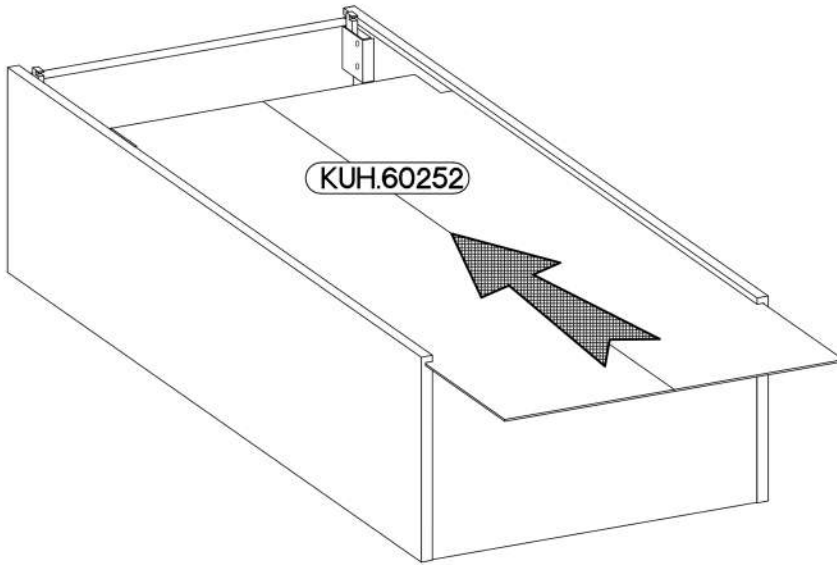

5

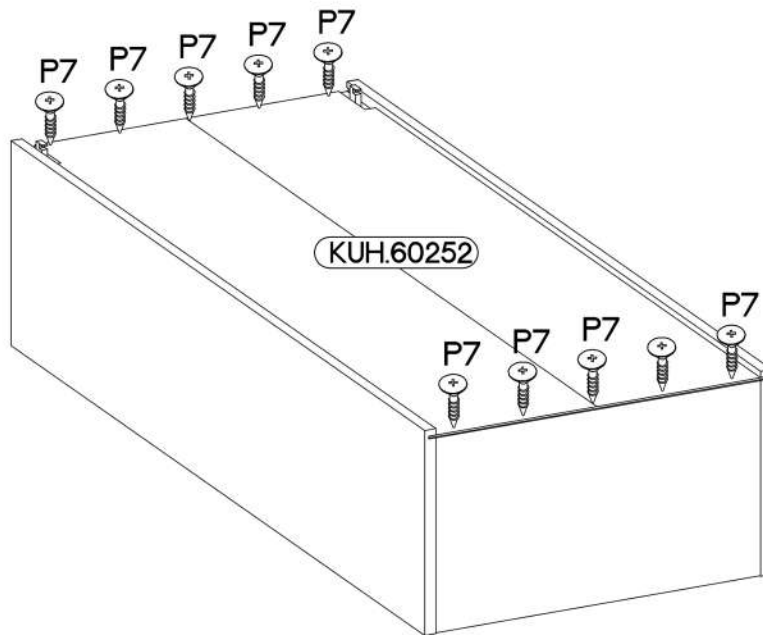
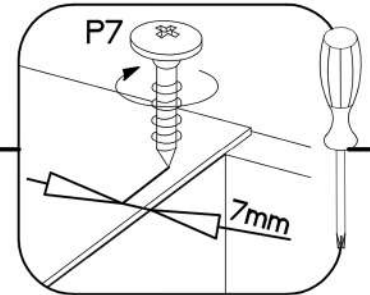
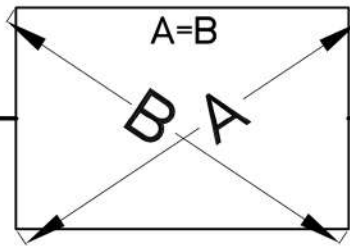

6

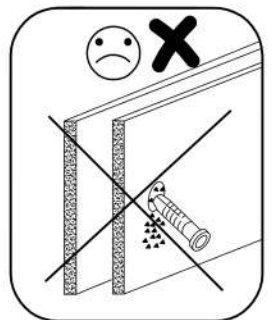
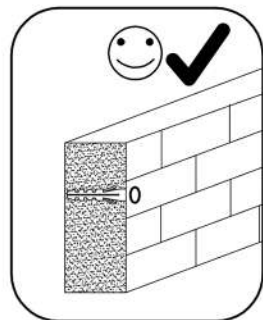
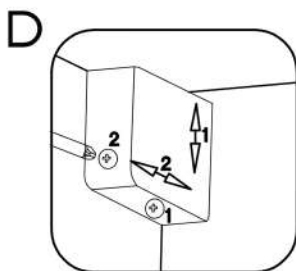
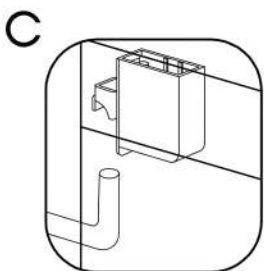
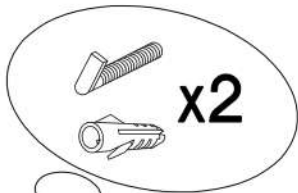
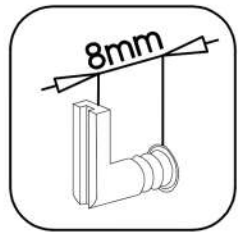
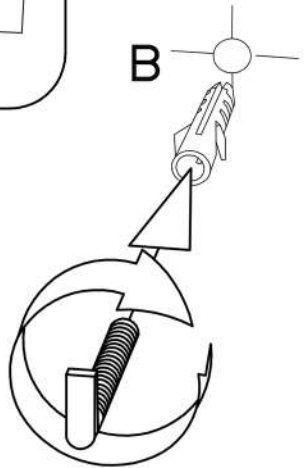
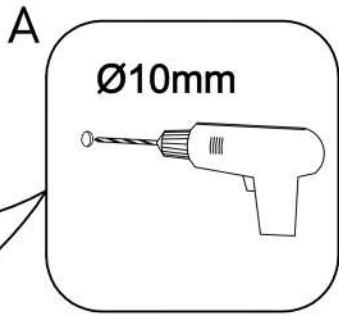
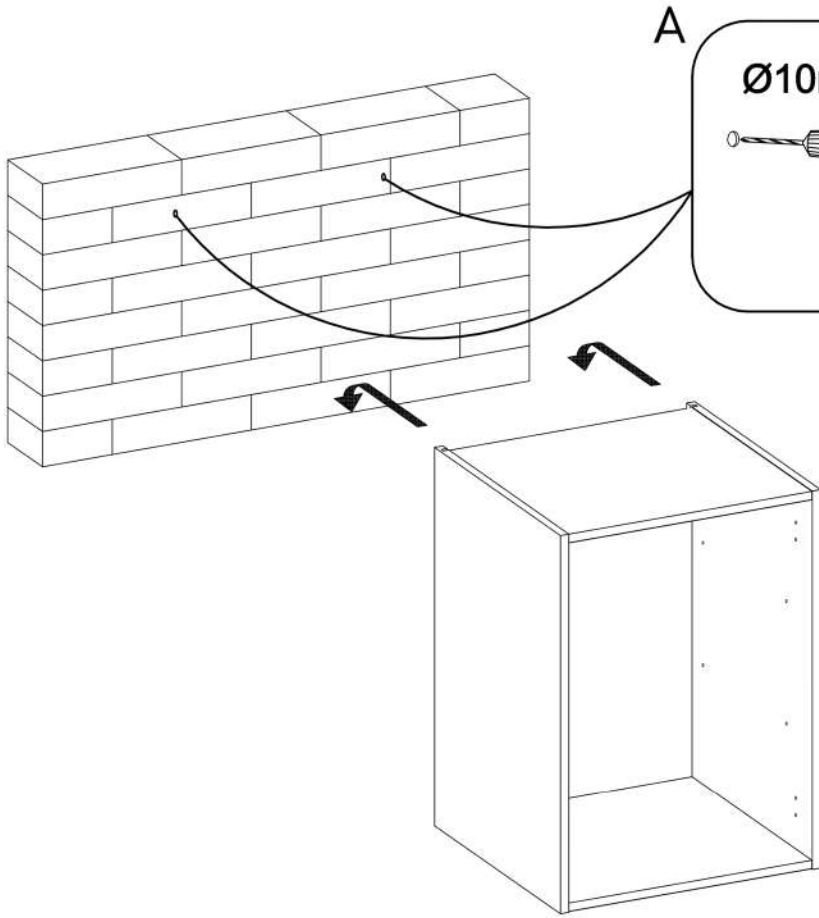
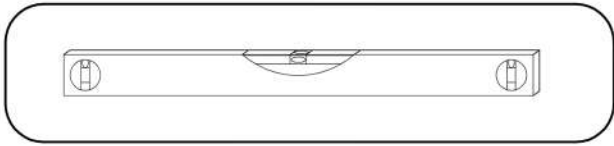

7

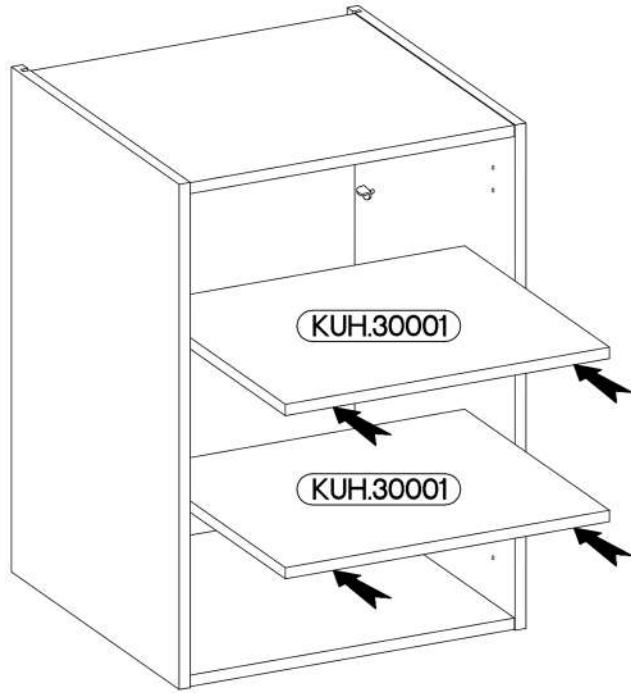
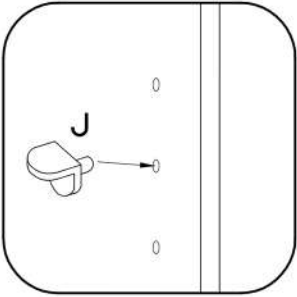
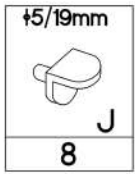

8

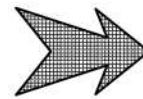
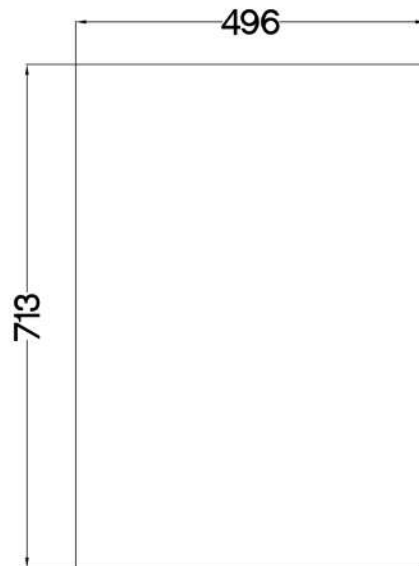

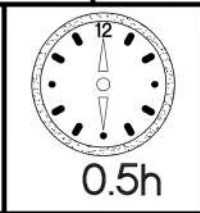
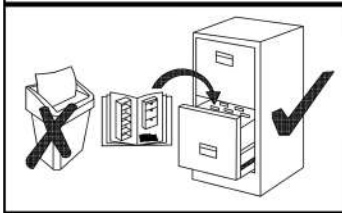
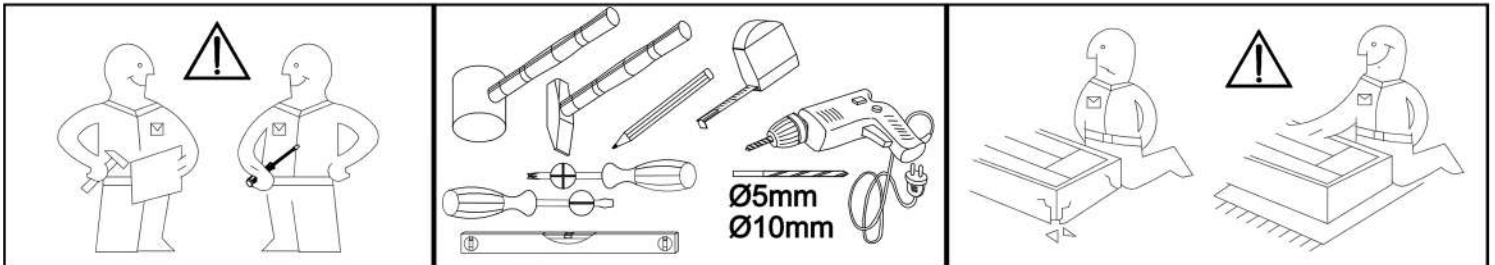

713x496

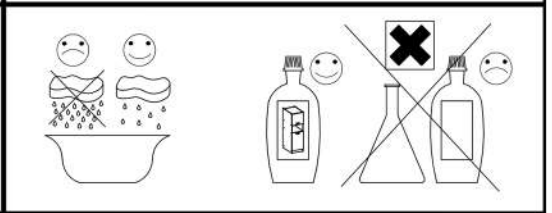

50 ZL 1F BB

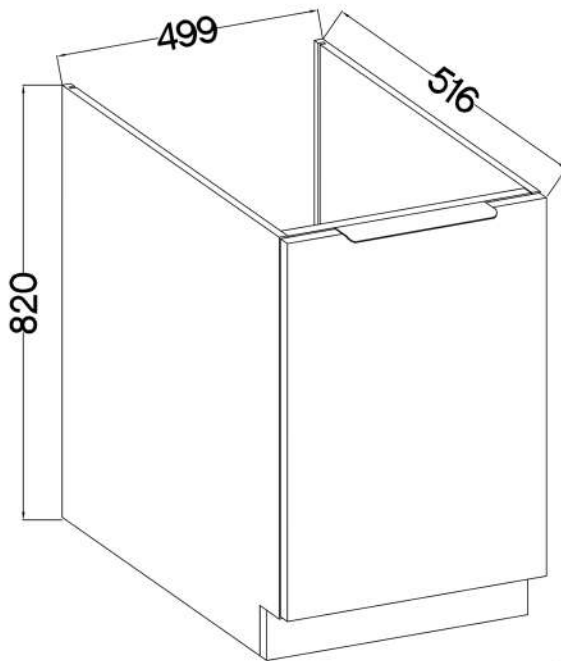

50 G-72 1F

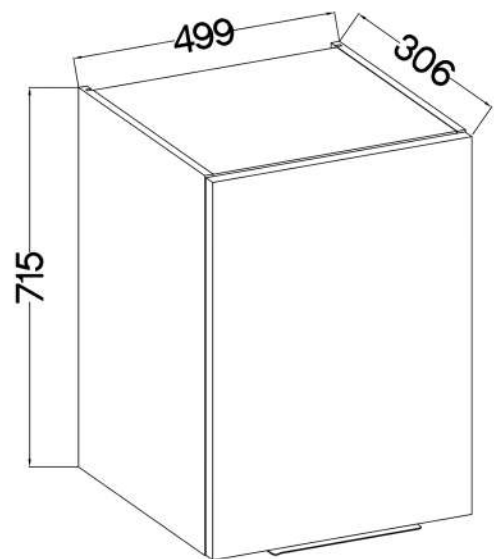

L=256mm	+7/2mm
S	J5
1	2

KUH.71150	713x496x16
-----------	------------

1 50 ZL 1F BB

$\pm 35/0\text{mm}$ [CD] HG 2	$\pm 3.5 \times 13\text{mm}$ P5 4	$\pm 7/2\text{mm}$ J5 2
---	---	-----------------------------------

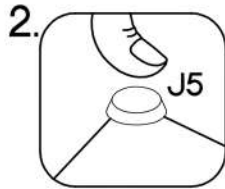
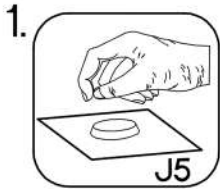
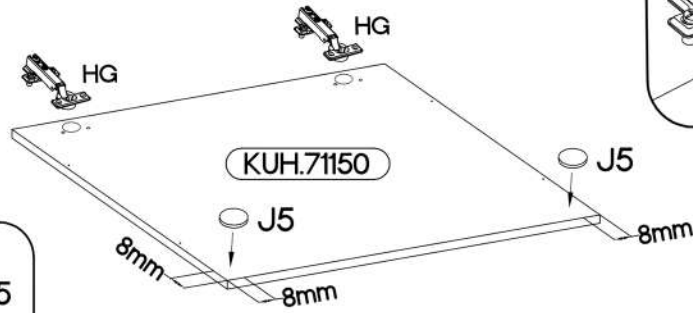
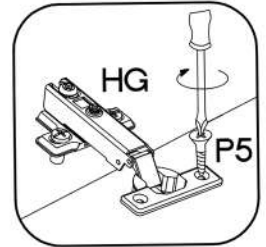

2

$L=256\text{mm}$ S 1

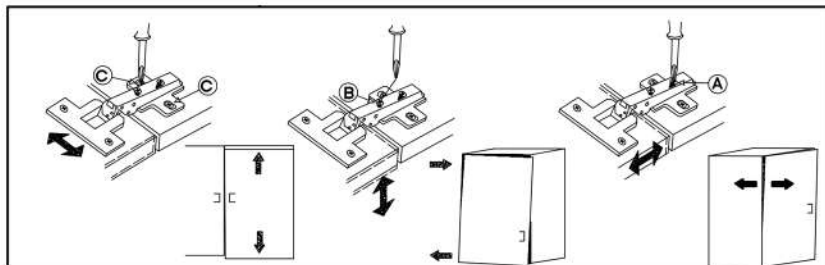
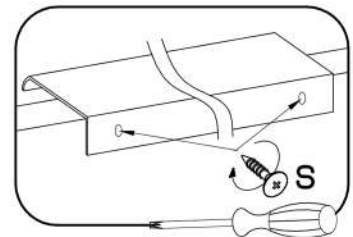
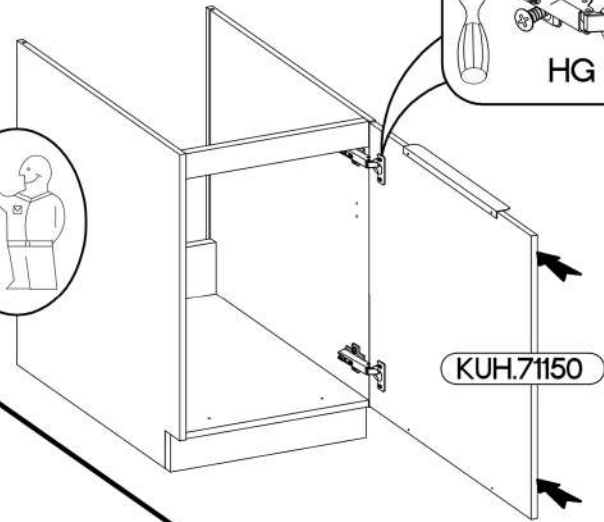
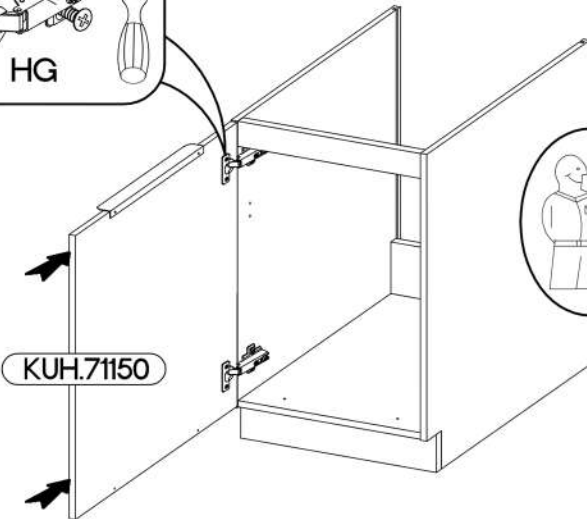
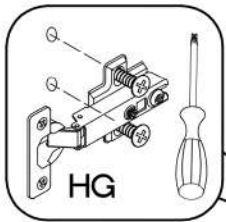
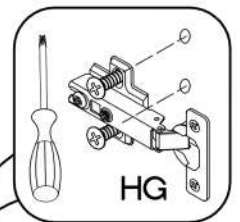

3

50 G-72 1F

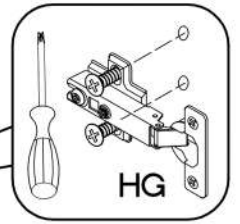
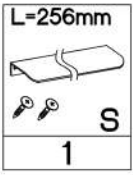

KUH.71150

KUH.71150

