

FRSIBO 60x60 GN-108 2F 90°

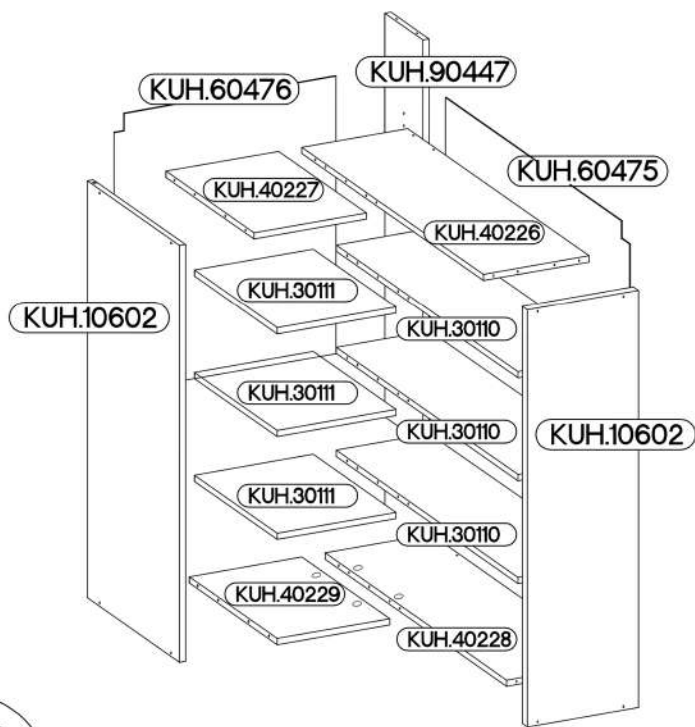

KUH.10602 x2	1073x290x16
KUH.30110 x3	570x244x16
KUH.30111 x3	310x260x16
KUH.40426	570x276x16
KUH.40427	294x276x16
KUH.40428	570x276x16
KUH.40429	294x276x16
KUH.60475	1070x578x2,5
KUH.60476	1070x578x2,5
KUH.90447	1039x120x16

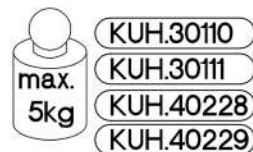
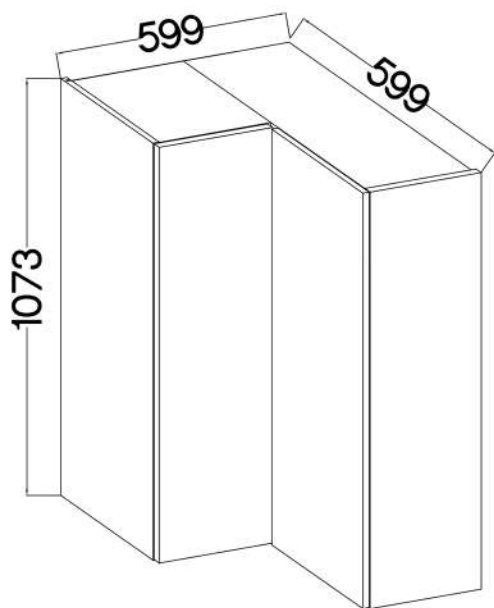
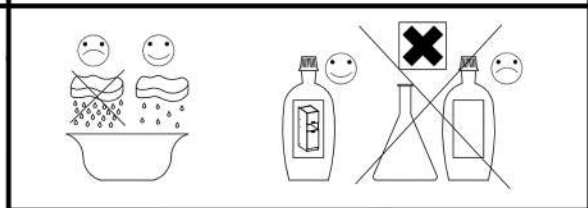

+8x30mm A	+8x60mm A2	6,4 x 50mm B	+15/12mm C	L=40mm D12	E	0,05 O11	+3.5x13mm P5
8	15	12	20	10	20	1	12
E1	+35/175 HG11	+5/16mm J3	K	O	+3.0x16mm P11	+4.0x30mm P8	
12	6	15	2	1	30-35	4	

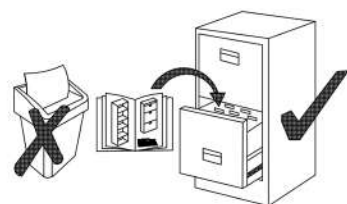

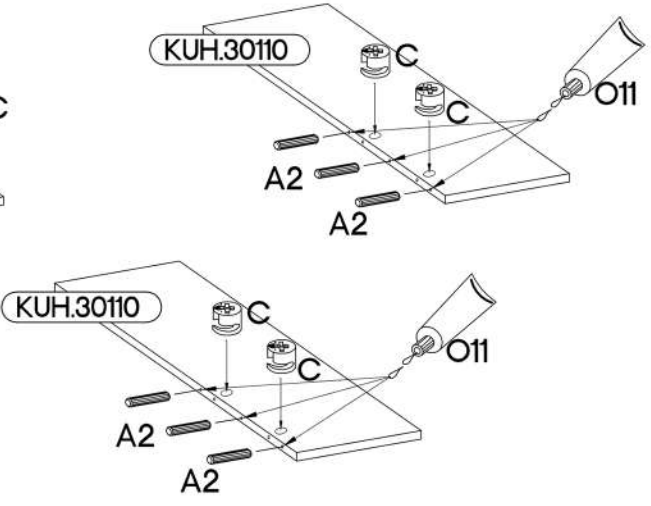
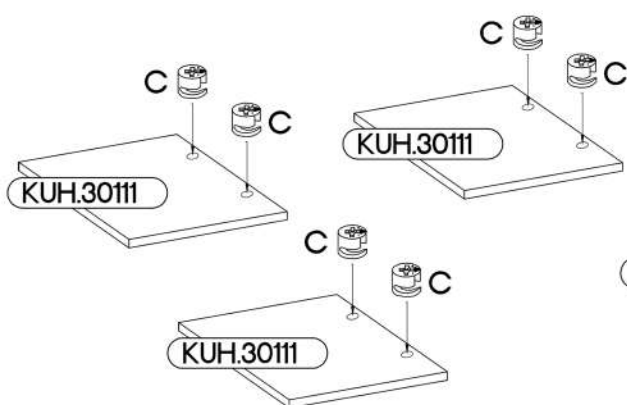
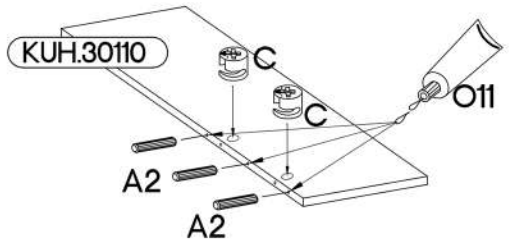
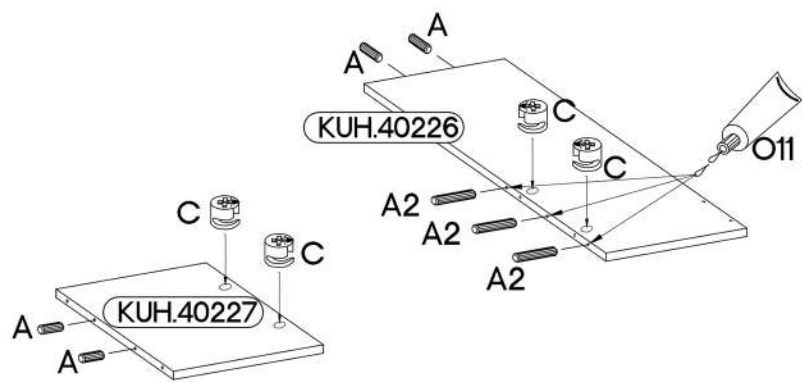
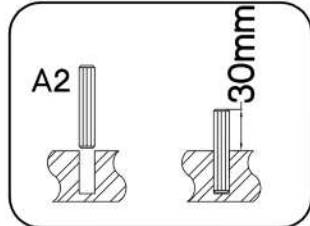
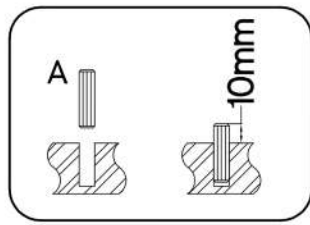
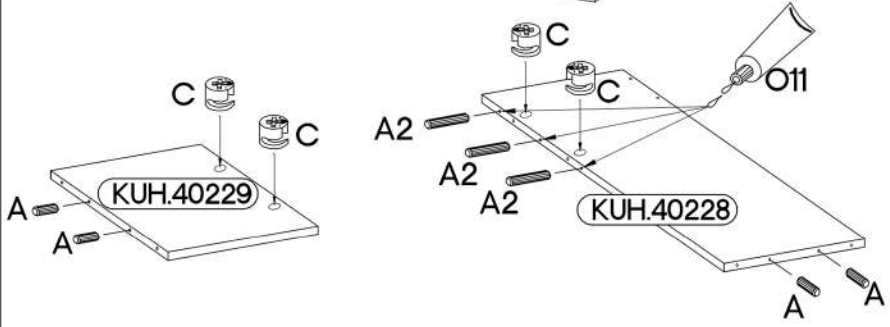
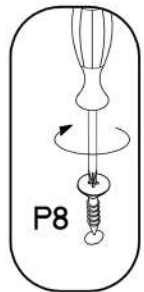
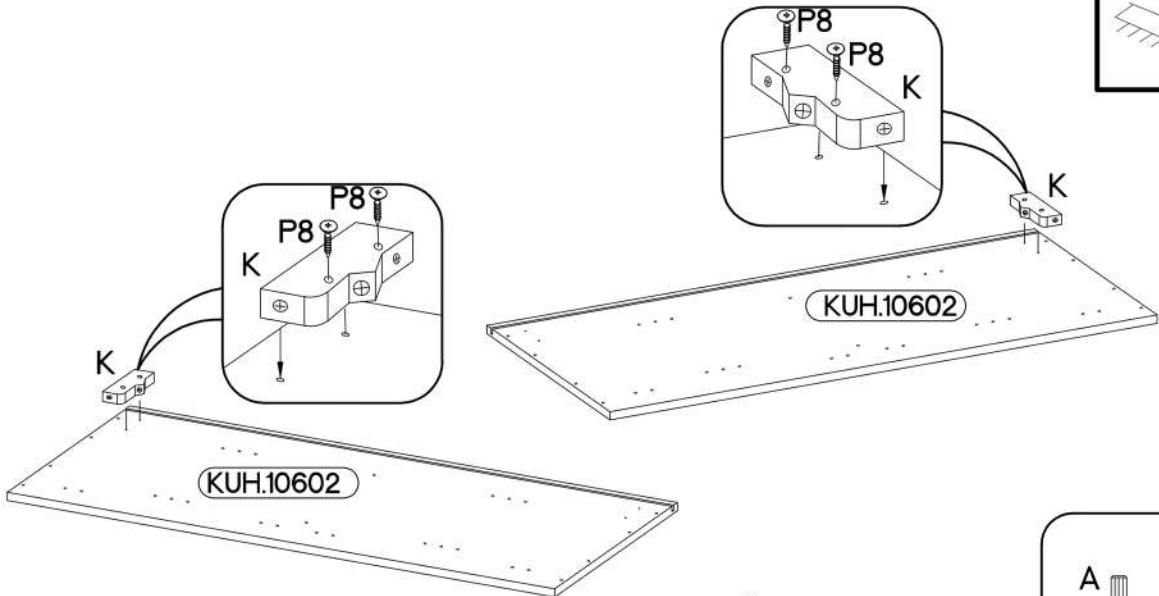

1

$\varnothing 8 \times 30\text{mm}$ A	$\varnothing 8 \times 60\text{mm}$ A2	$\varnothing 15/12\text{mm}$ C	$\varnothing 4.0 \times 30\text{mm}$ P8	K	0,05 O11
8	15	20	4	2	1



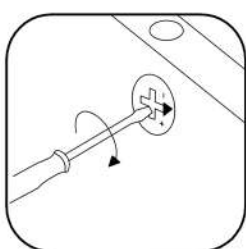
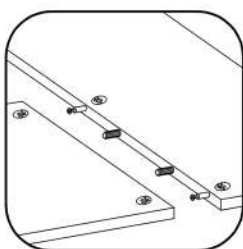
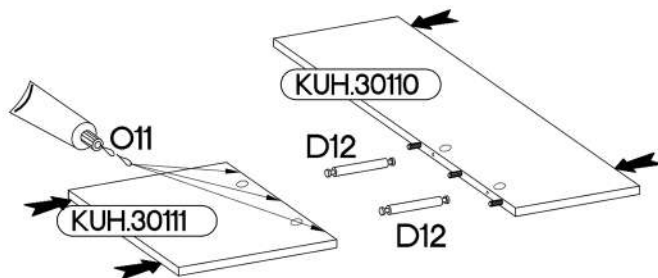
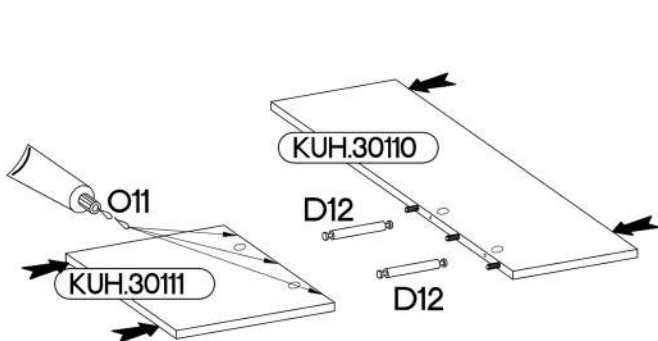
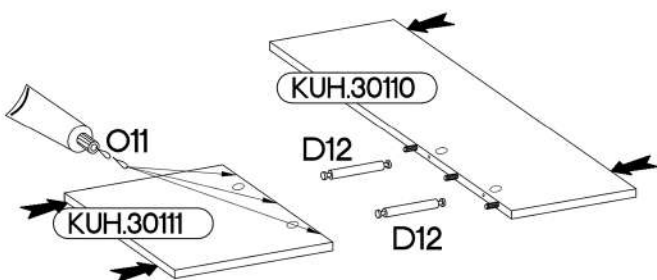
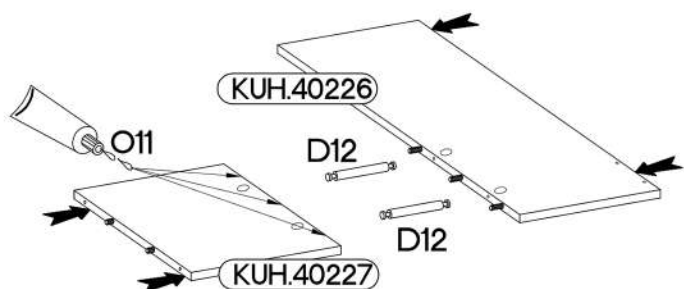
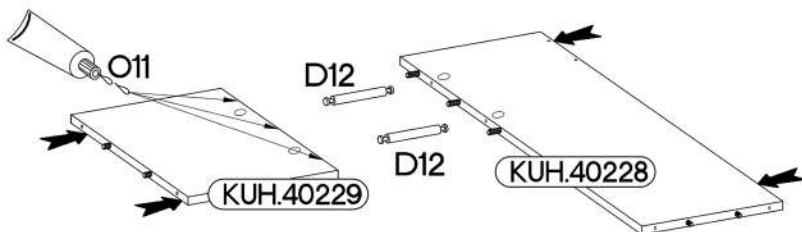
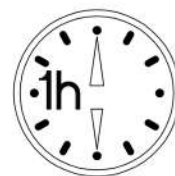
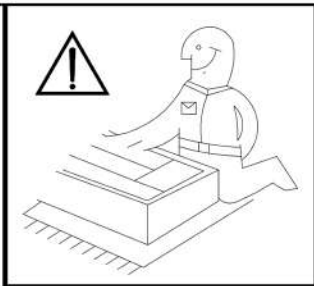
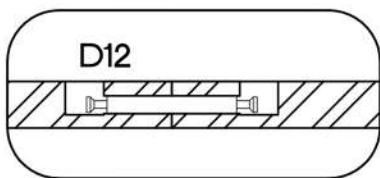

2

L=40mm 	0,05 
D12 10	O11 1





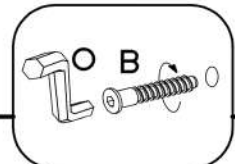
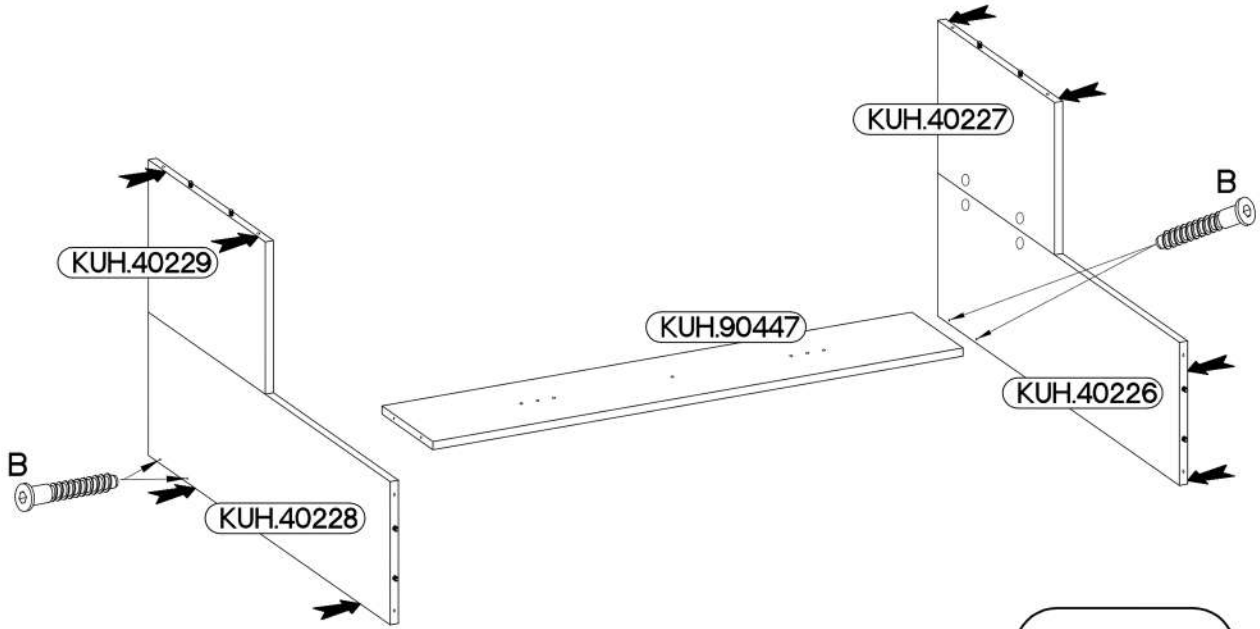

3

6,4 x 50mm		
		
B	O	E1
4	1	4

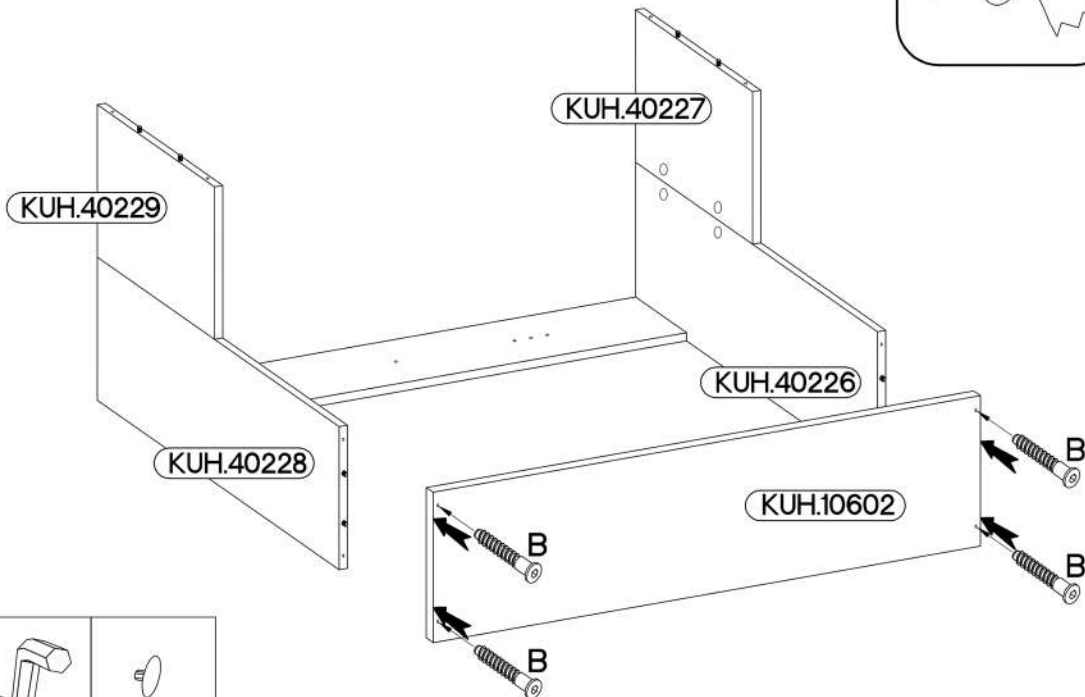



4





6,4 x 50mm		
		
B	O	E1
4	1	4

5

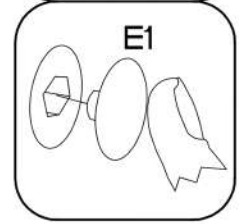
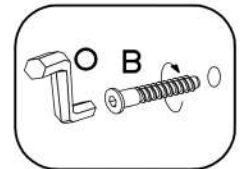
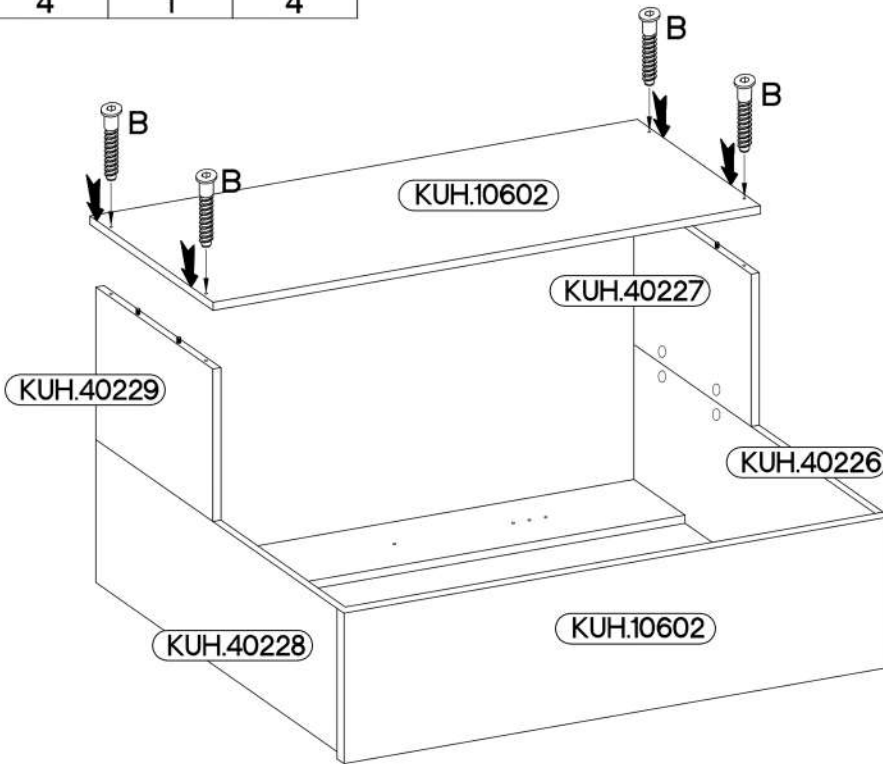
6,4 x 50mm			
	B	O	E1
	4	1	4



6

±5/16mm		
	J3	E
	15	20

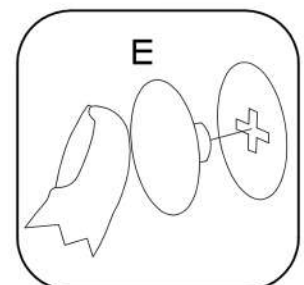
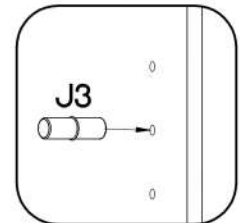
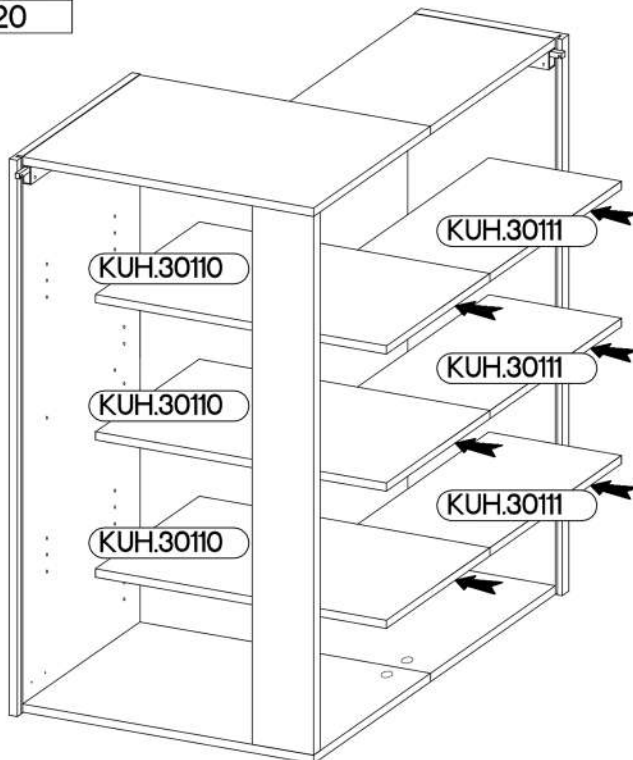

7

±3.0x16mm
P11
17

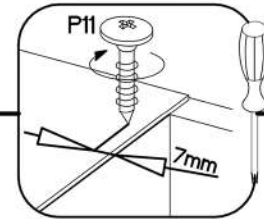
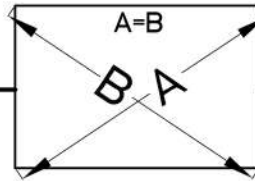
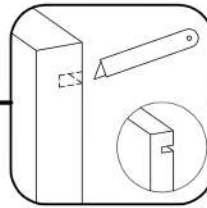
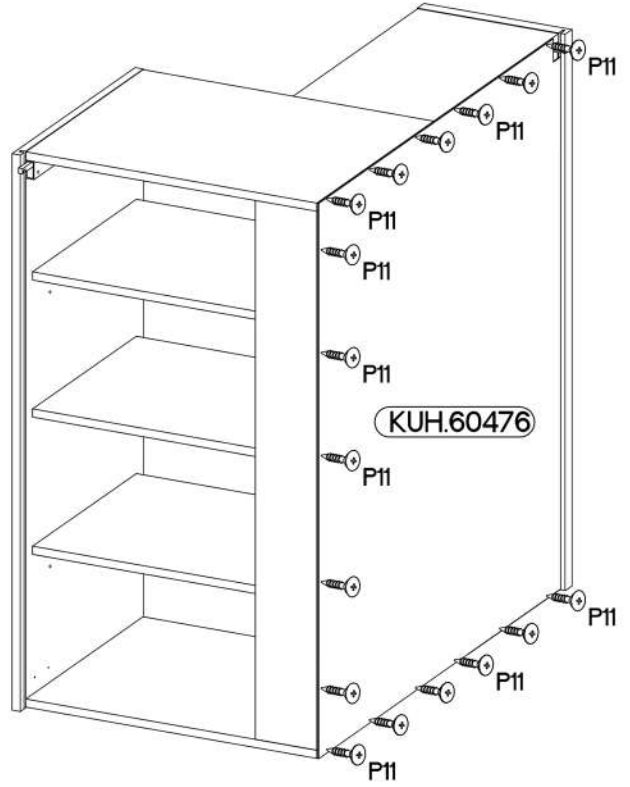
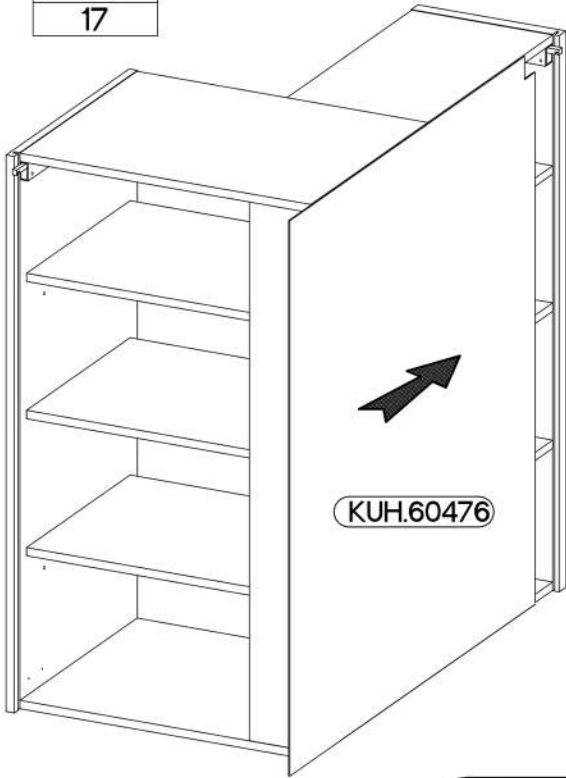

8

±3.0x16mm
P11
17

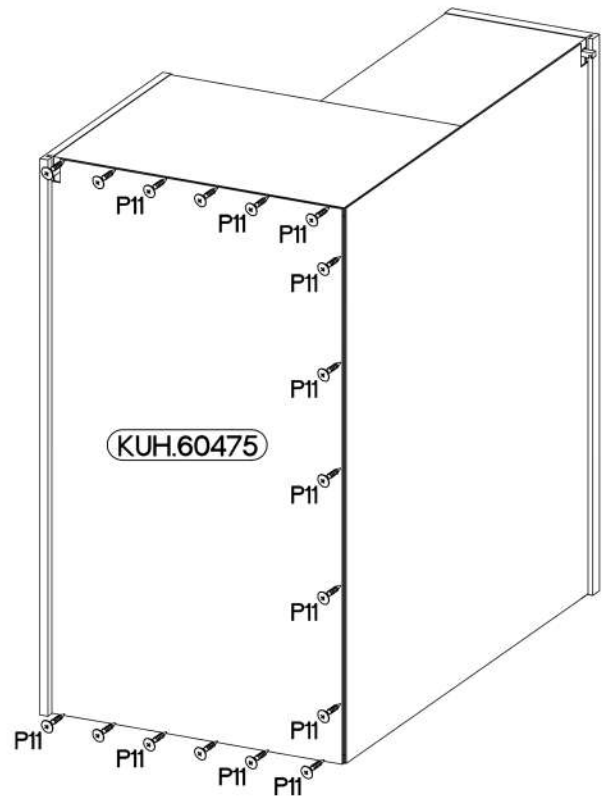
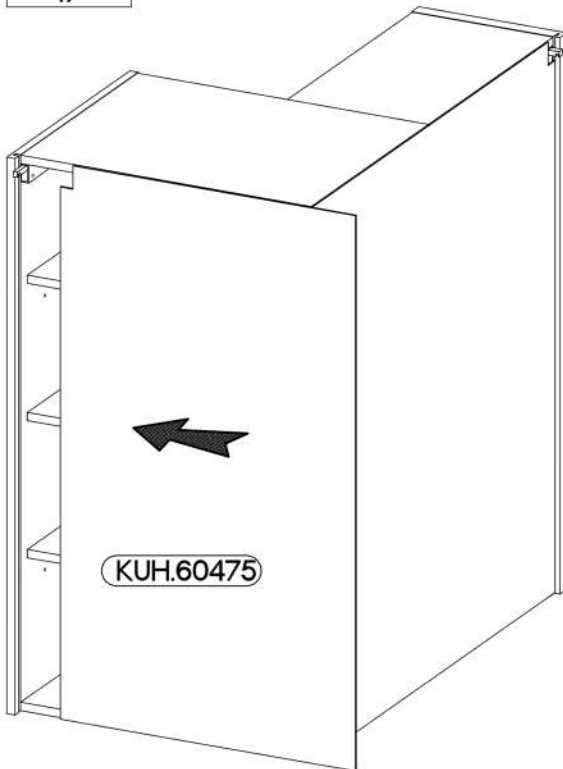

9

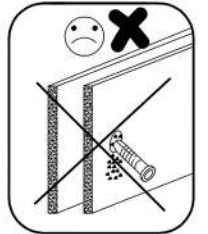
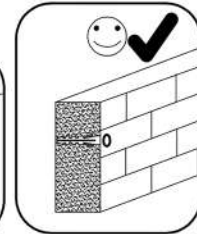
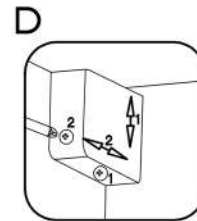
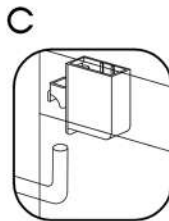
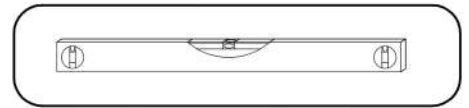
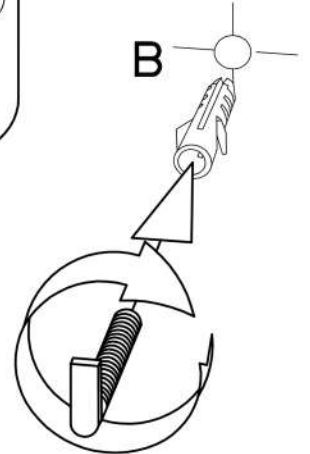
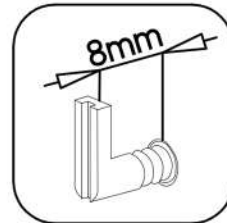
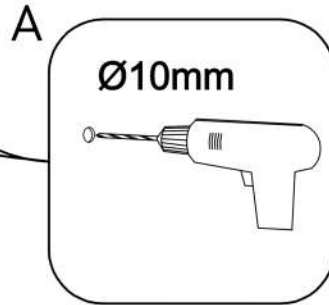
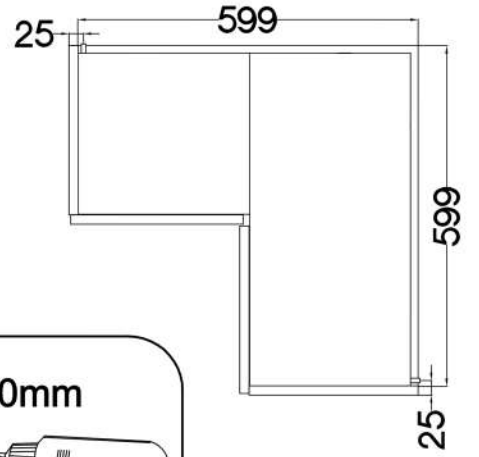
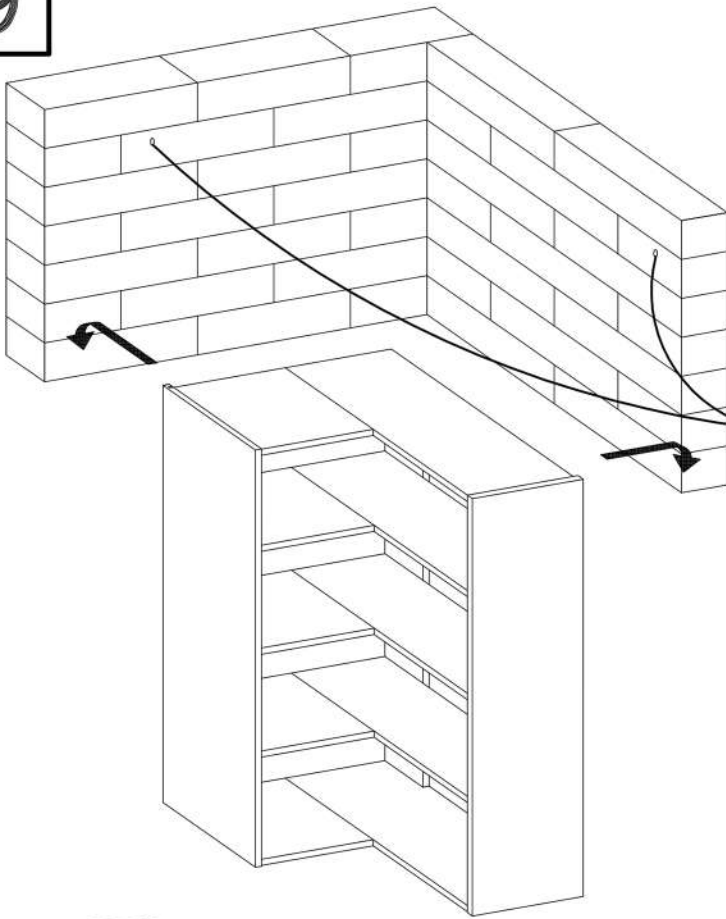

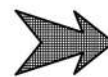
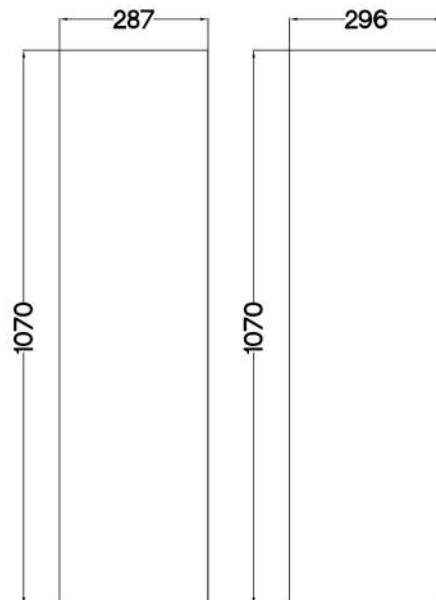

10

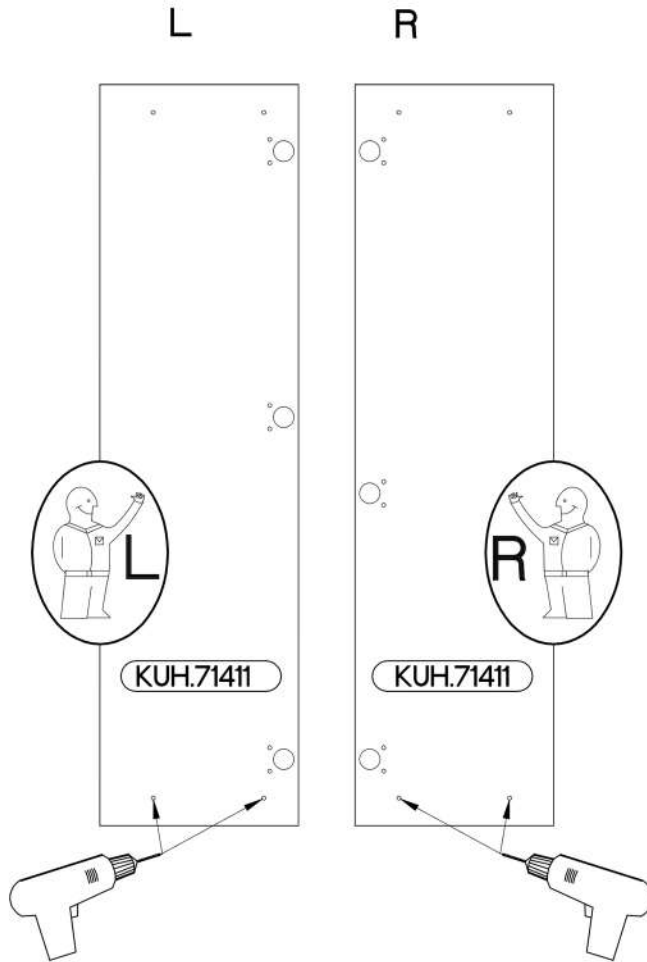

1



2

	
HG11	P5
6	12

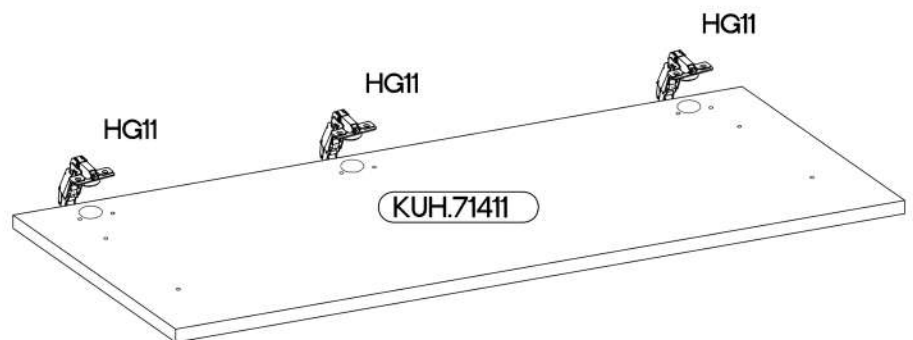
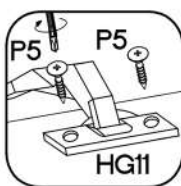
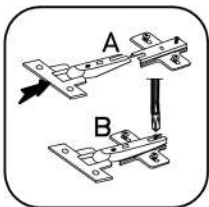
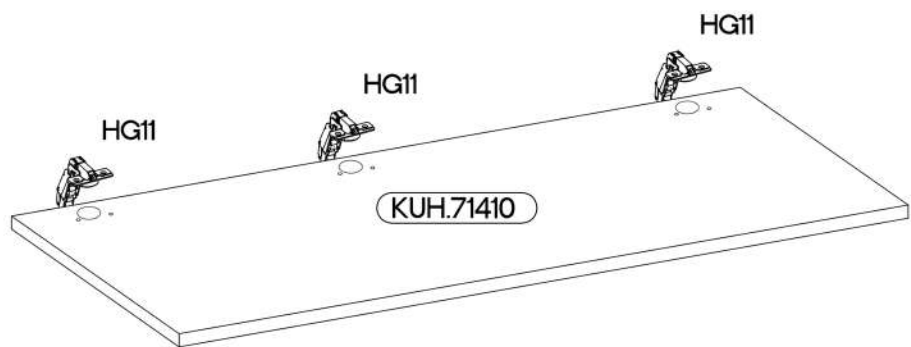

3

