

FRISBO 60x60 GN-72 2F 90°

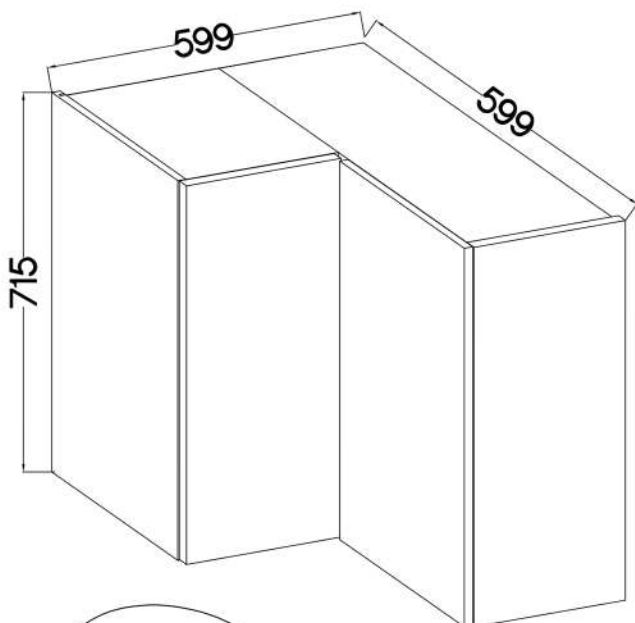

- KUH.30110
- KUH.30111
- KUH.40228
- KUH.40229

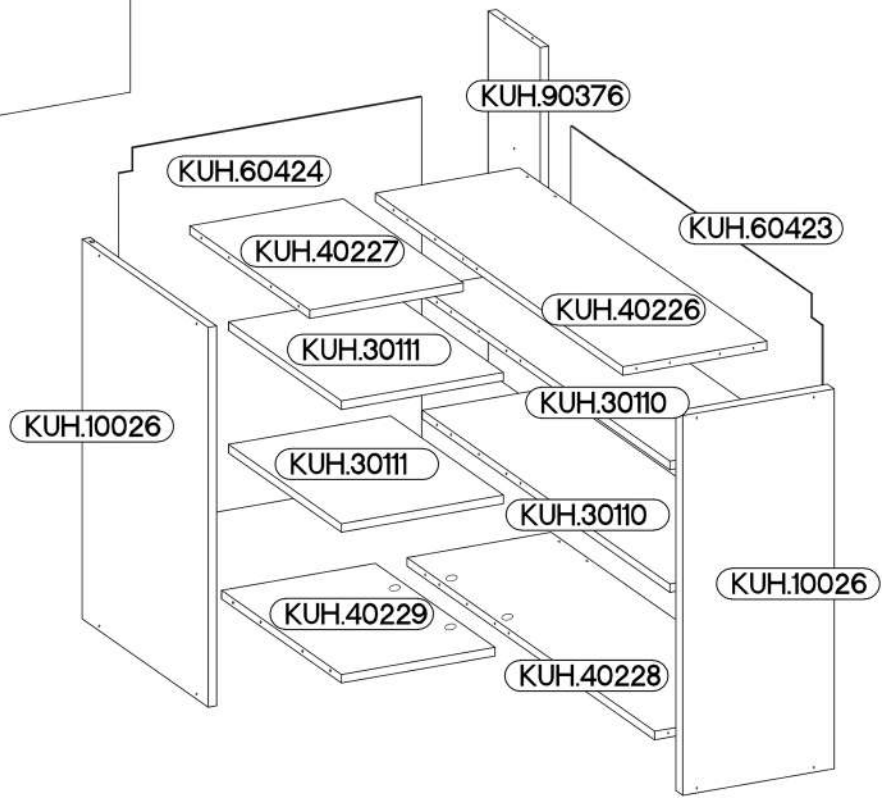





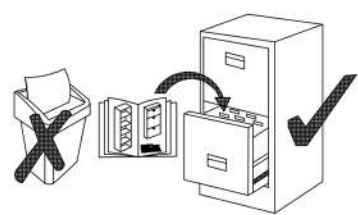

KUH.10026 x2	715x290x16
KUH.30110 x2	570x244x16
KUH.30111 x2	310x260x16
KUH.40426	570x276x16
KUH.40427	294x276x16
KUH.40428	570x276x16
KUH.40429	294x276x16
KUH.60423	713x578x2,5
KUH.60424	713x578x2,5
KUH.90376	681x120x16

A	A2	B	C	D12	E	O11	P5
8	12	12	16	8	16	1	8
E1	HG11	J	K	O	P11	P8	
12	4	10	2	1	30-35	4	



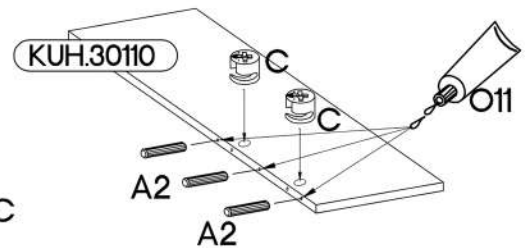
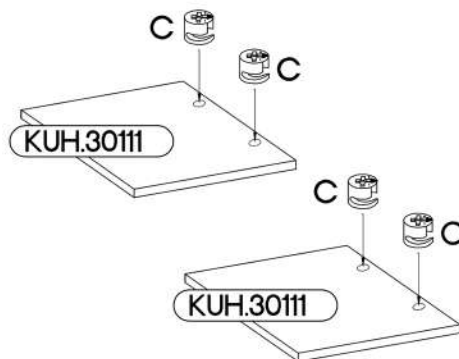
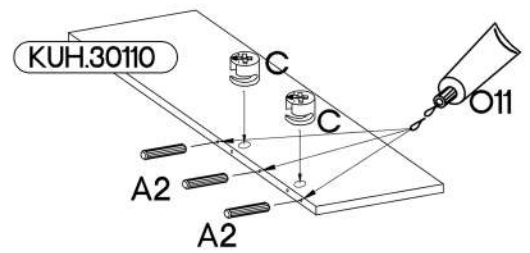
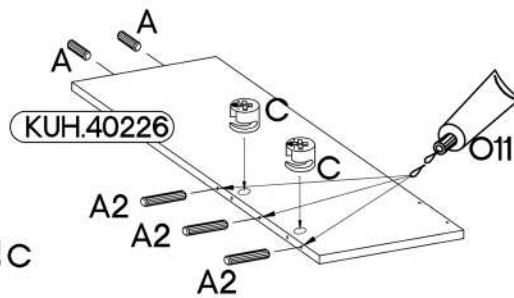
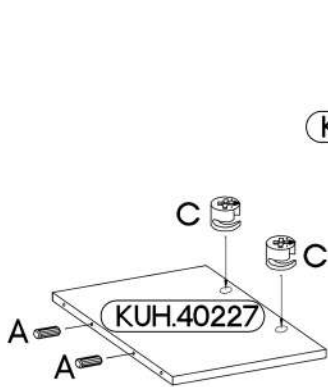
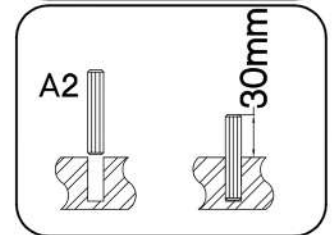
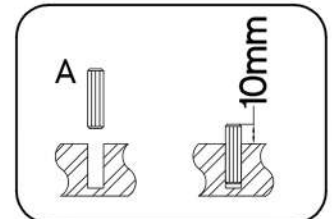
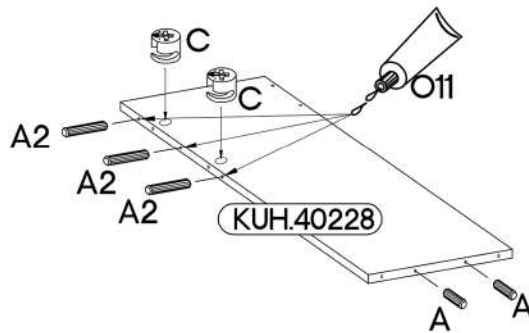
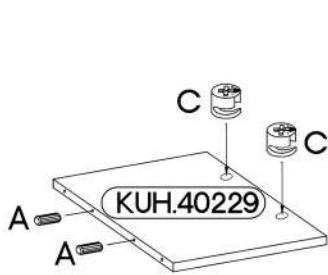
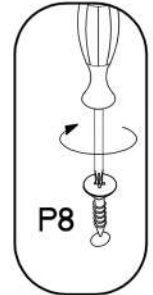
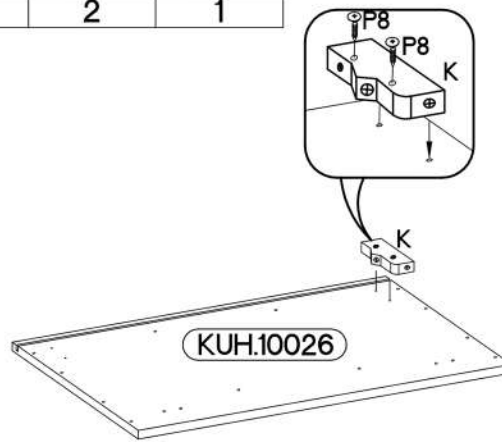
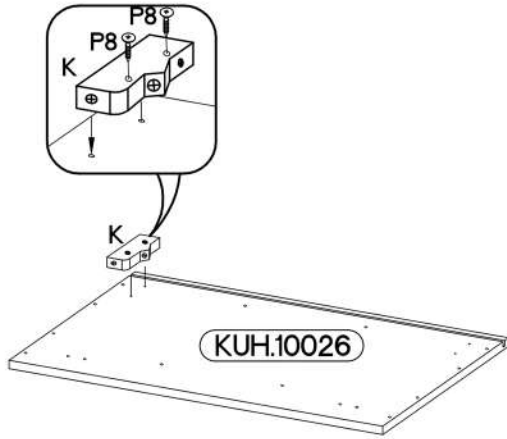
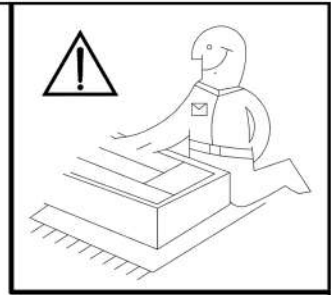

1

$\pm 8 \times 30 \text{mm}$  A 8	$\pm 8 \times 60 \text{mm}$  A2 12	$\pm 5/12 \text{mm}$  C 16	$\pm 4.0 \times 30 \text{mm}$  P8 4	 K 2	0,05  O11 1
--	--	--	---	---	---



2

L=40mm	0,05
	
D12	O11
8	1

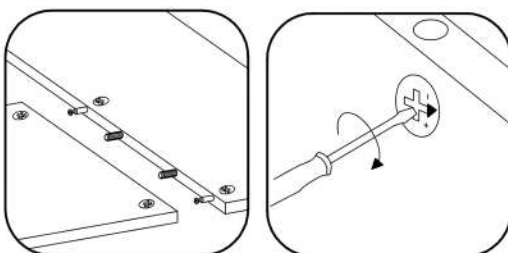
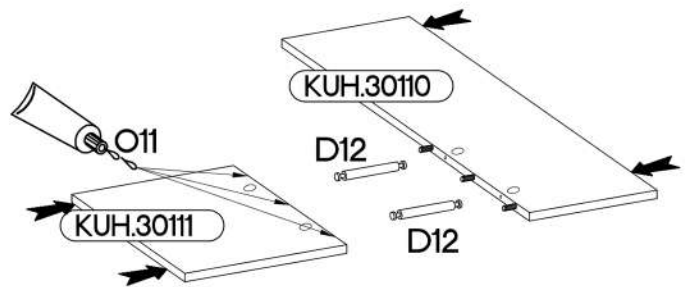
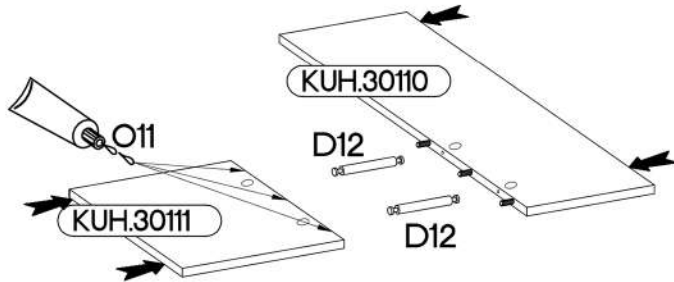
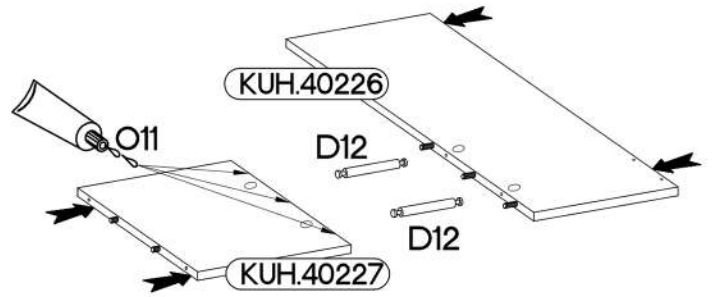
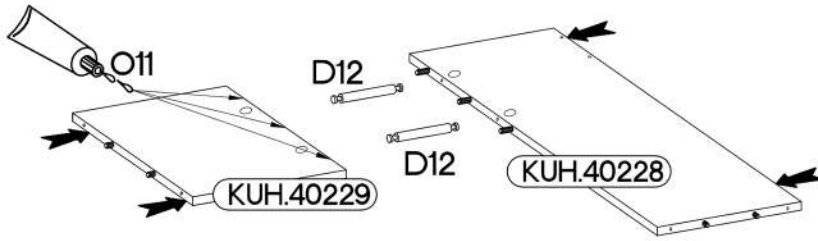
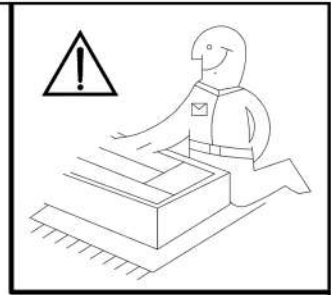
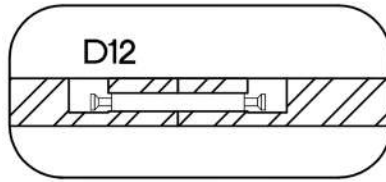

3

6,4 x 50mm

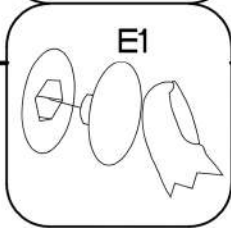
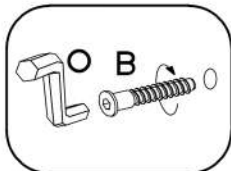
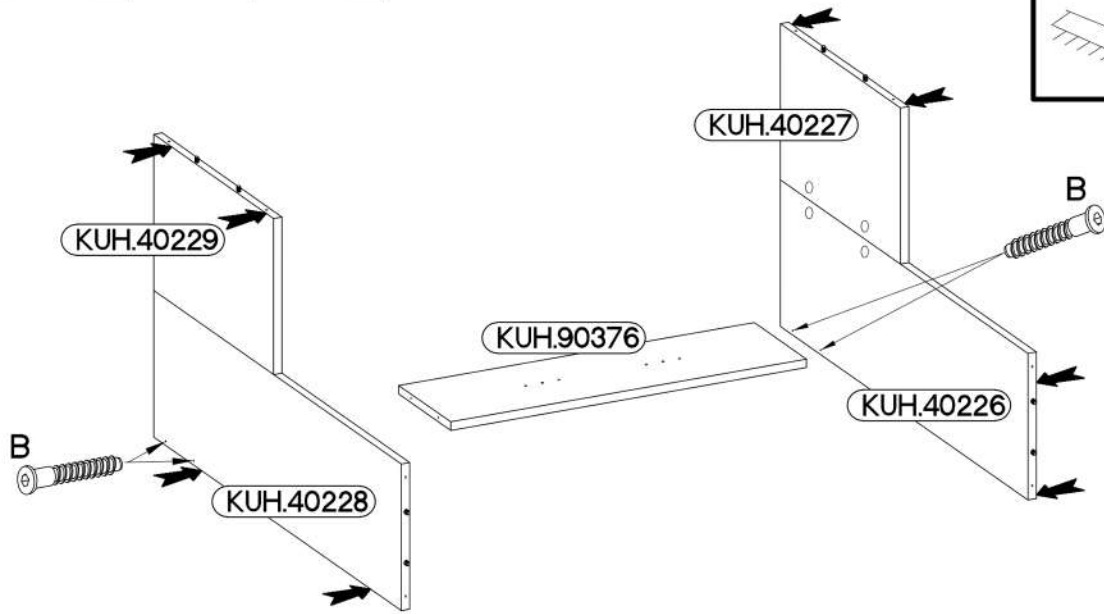
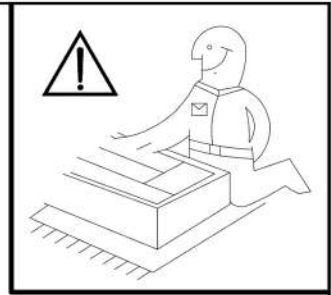
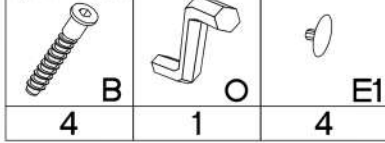

4

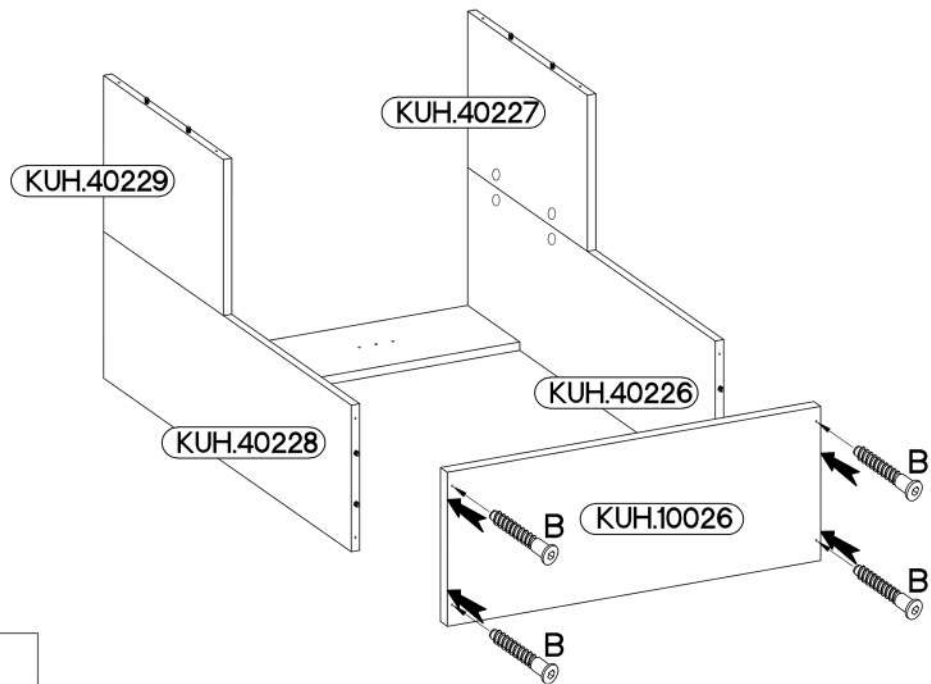

6,4 x 50mm

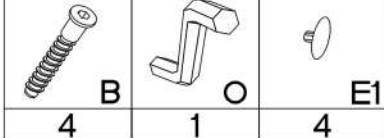

5

6,4 x 50mm

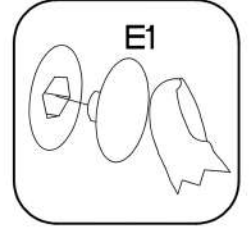
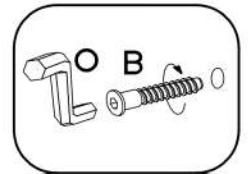
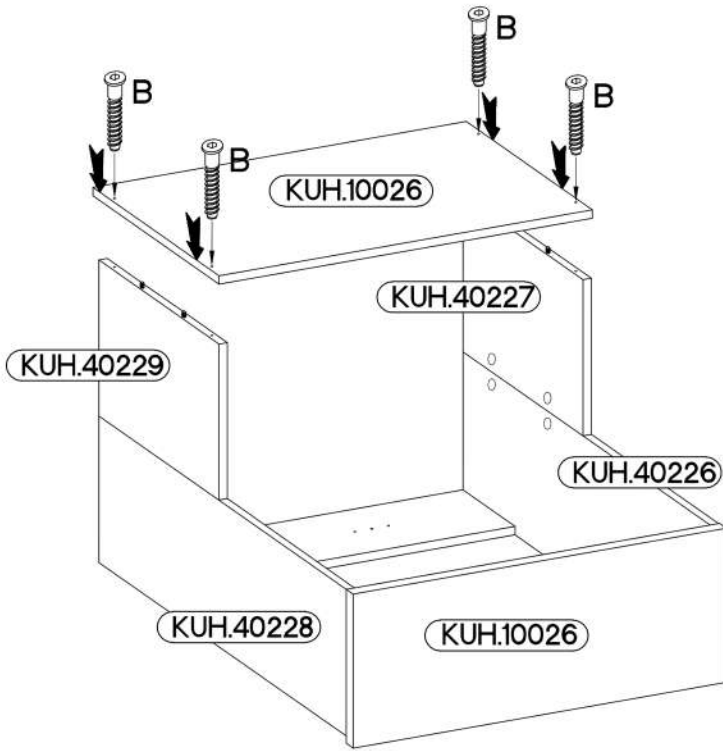
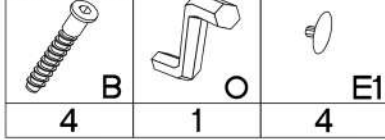

6

±5/19mm

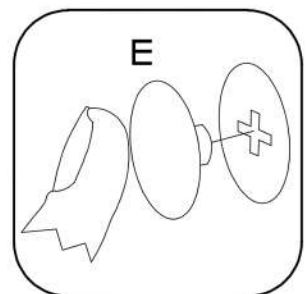
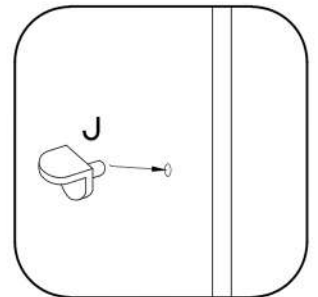
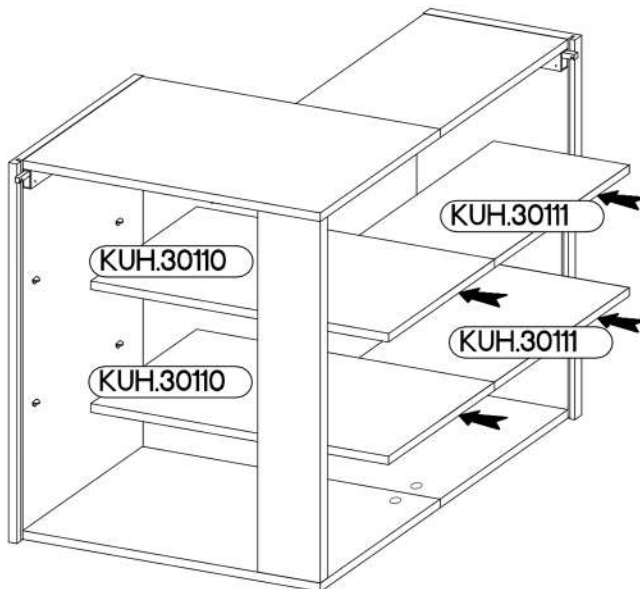
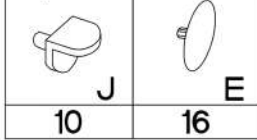

7

+3.0x16mm

 P11
 15

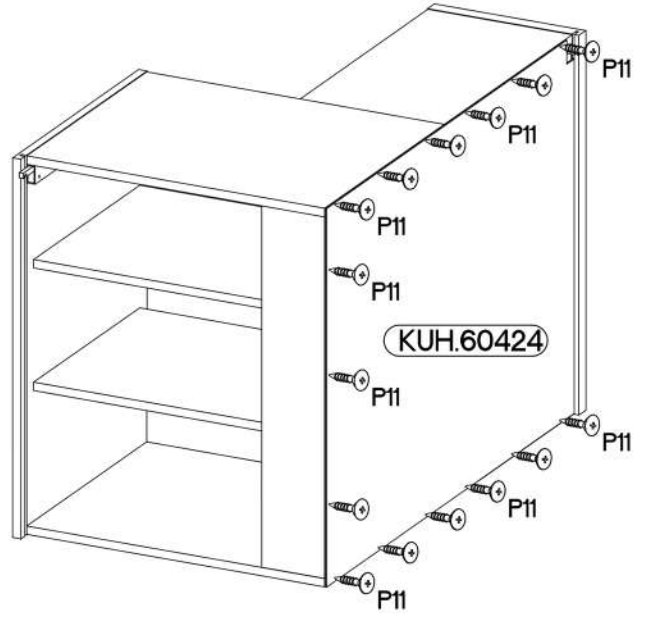
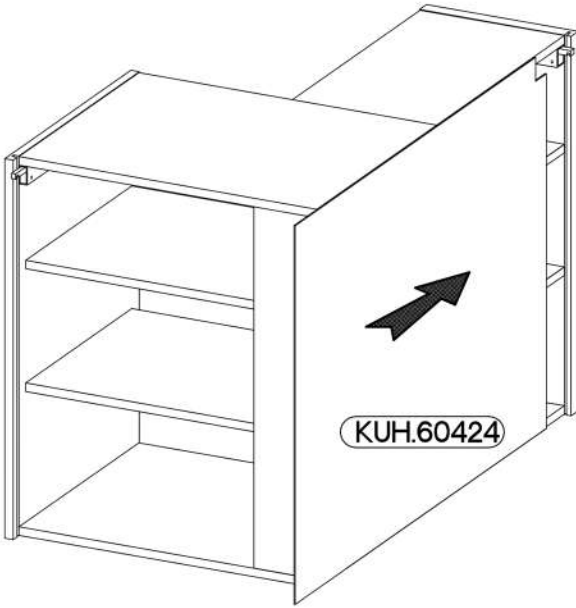

8

+3.0x16mm

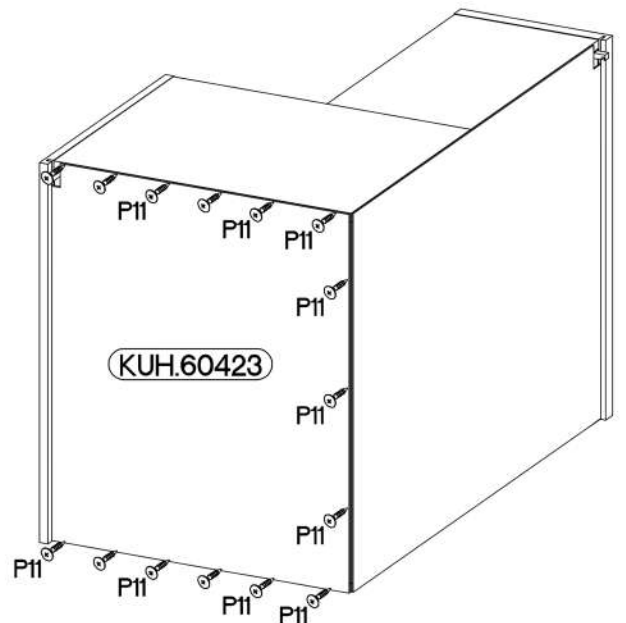
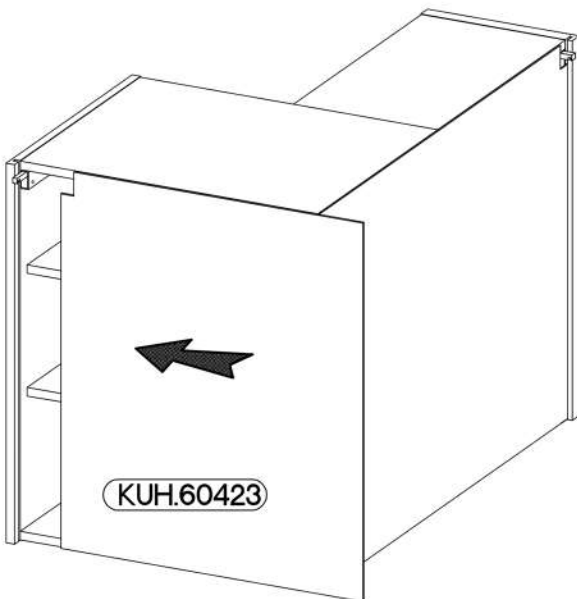
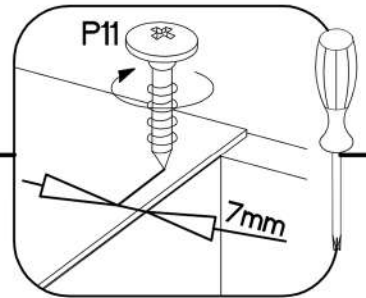
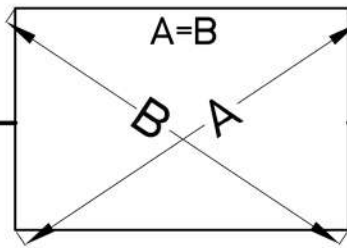
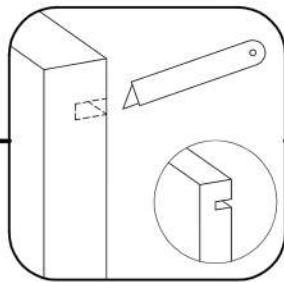
 P11
 15

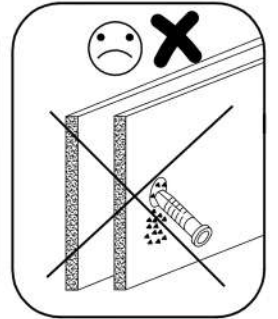
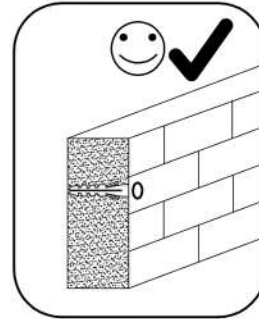
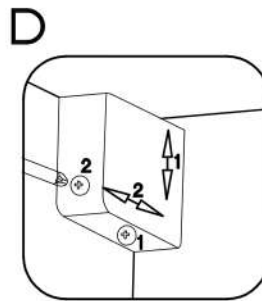
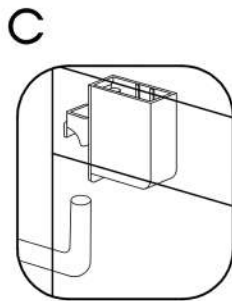
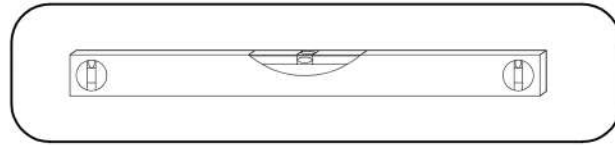
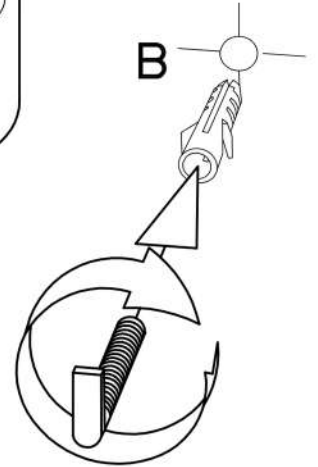
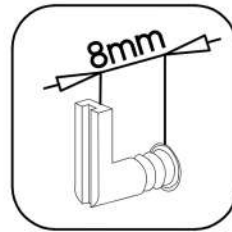
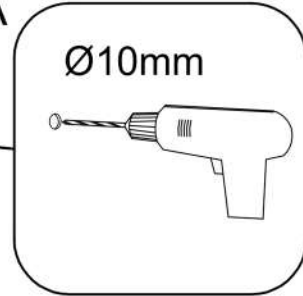
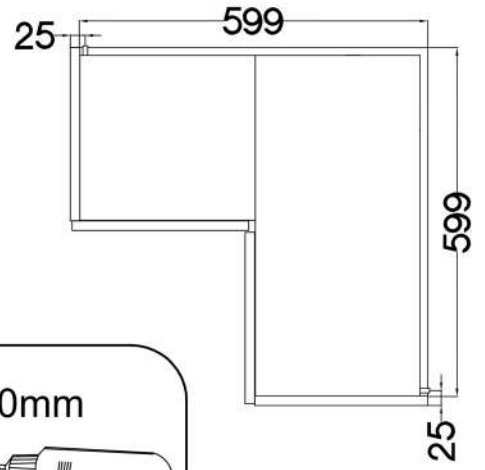
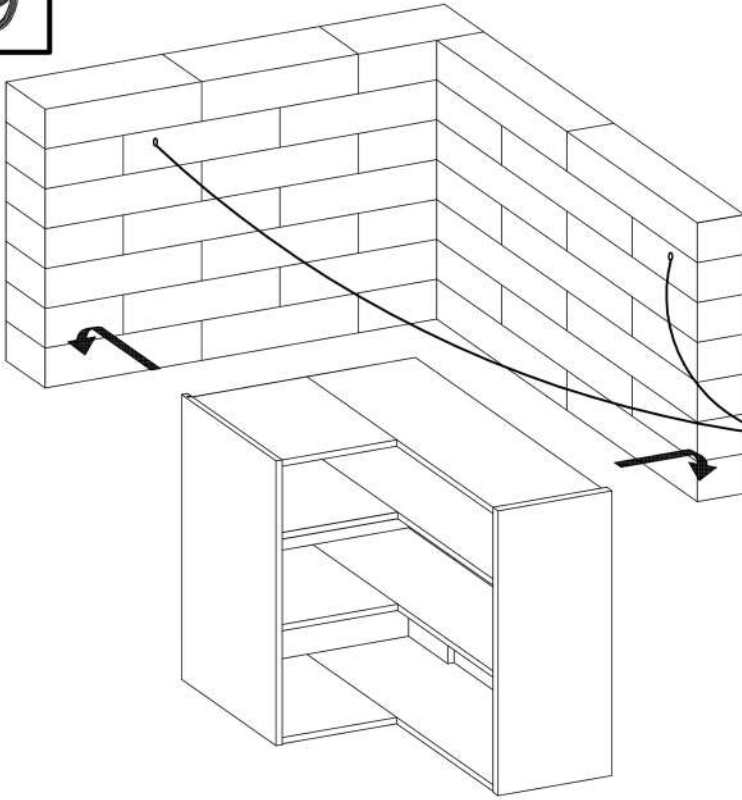

9

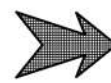
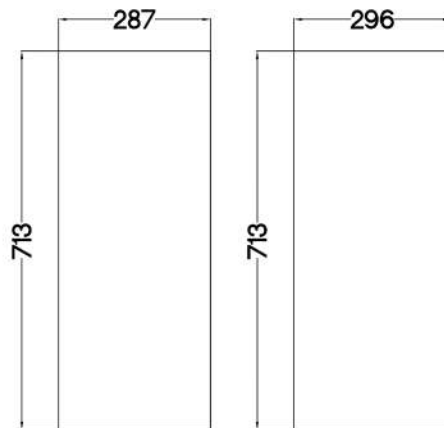

10



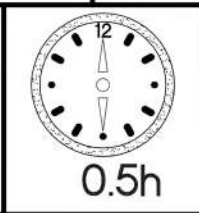
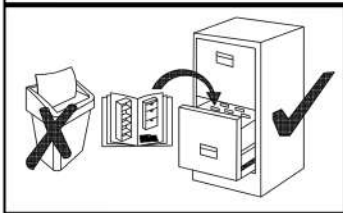
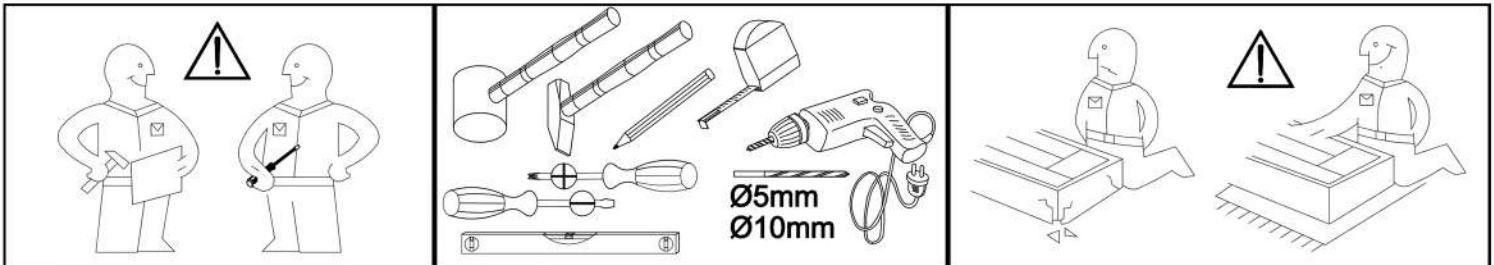

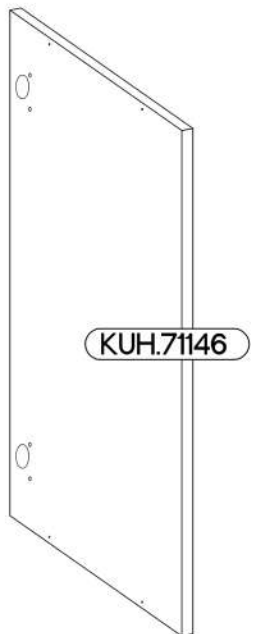
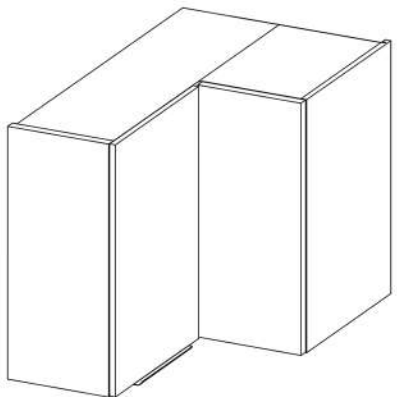
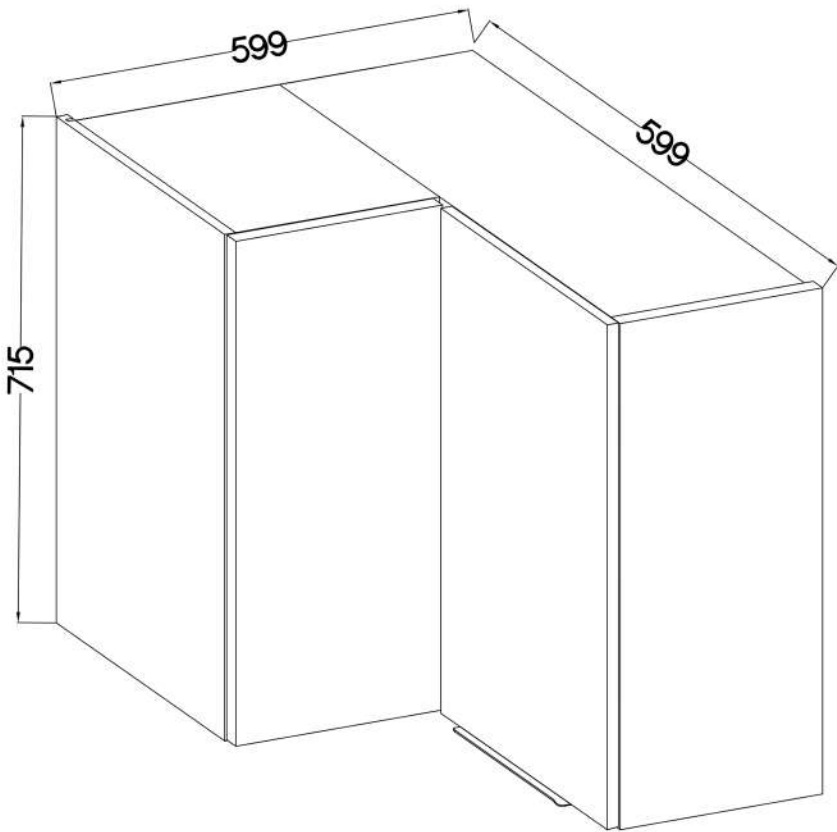
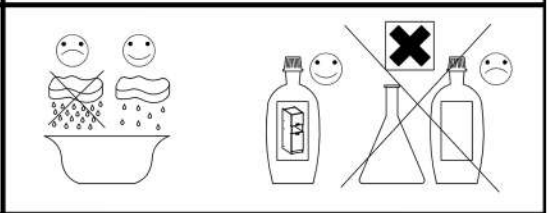

60x60 GN-72 2F



L=160mm	±7/2mm
S	J5
1	4

KUH.71146	713x296x16
KUH.71177	713x287x16

1

 HG11 4	 P5 8	 J5 4
---	---	---

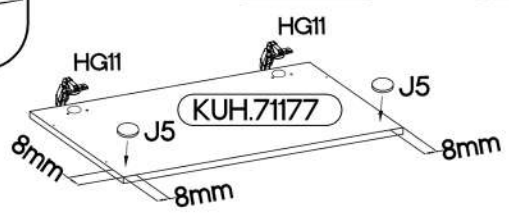
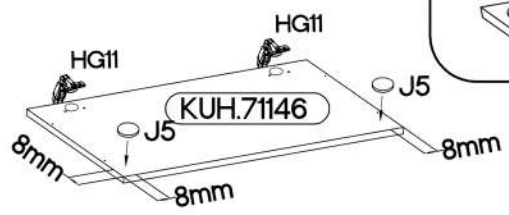
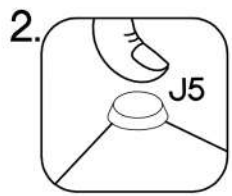
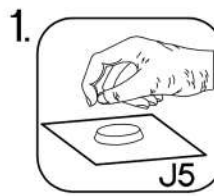
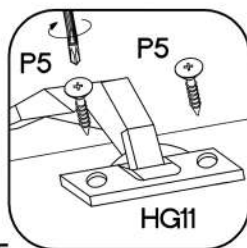

2

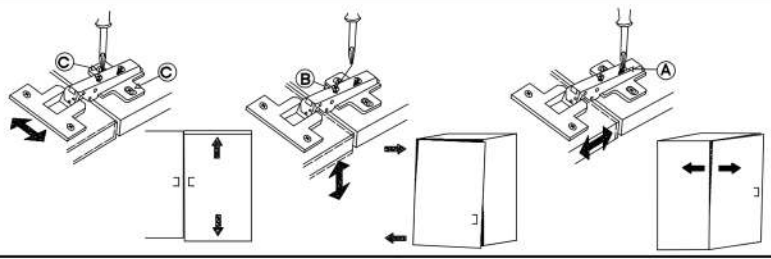
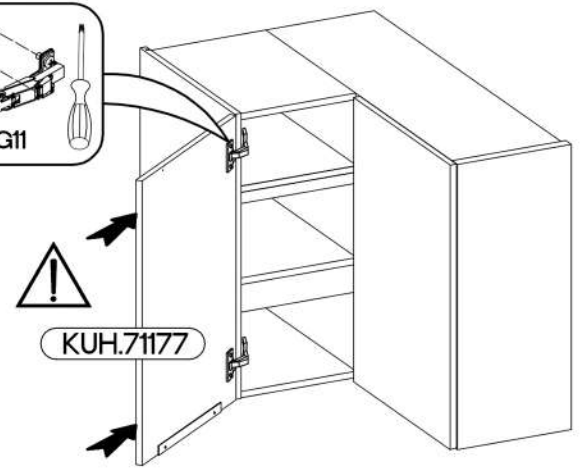
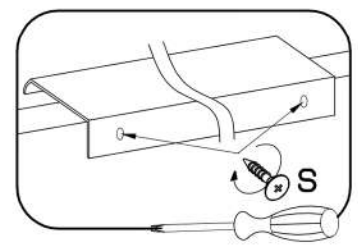
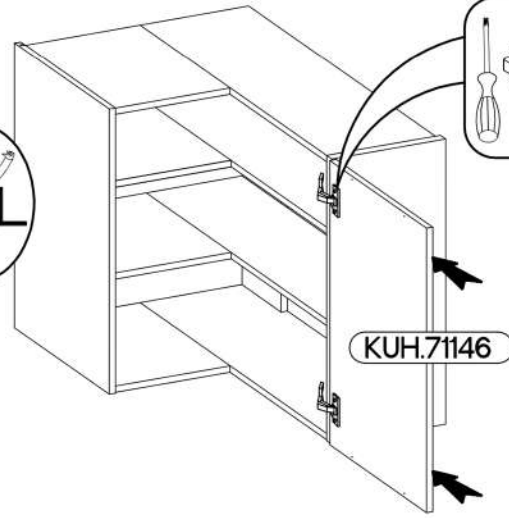
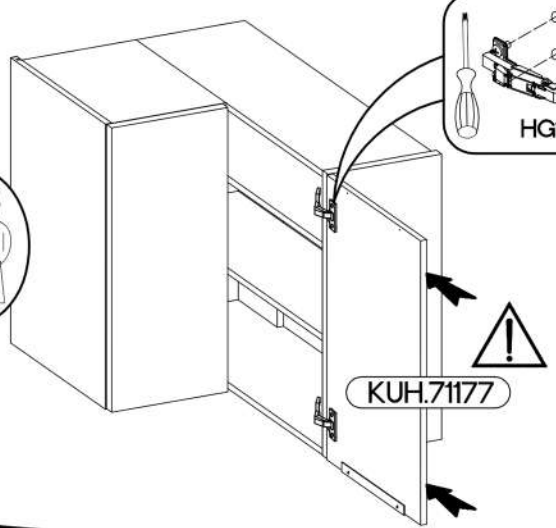
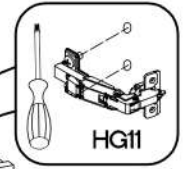
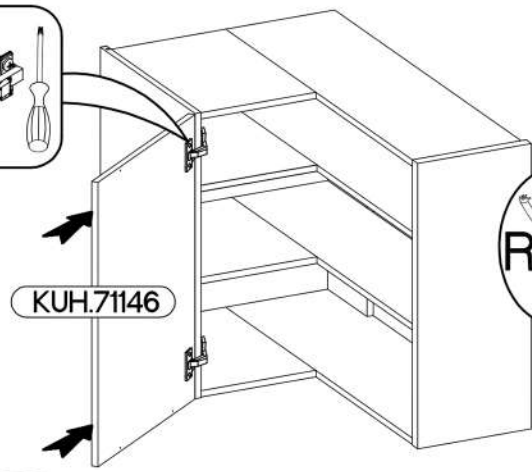

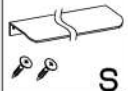
L=160mm

S
1