

FRISBO 60 G-90 1F

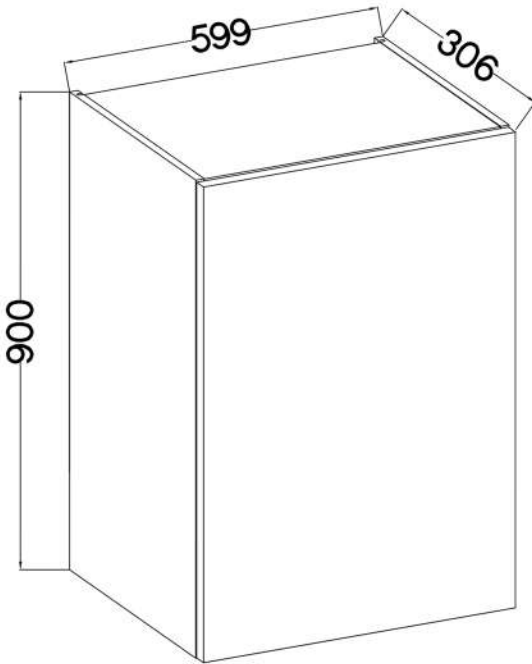

KUH.30004
KUH.40009

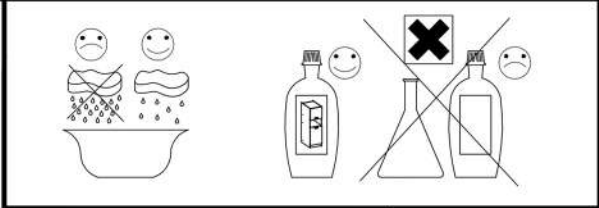

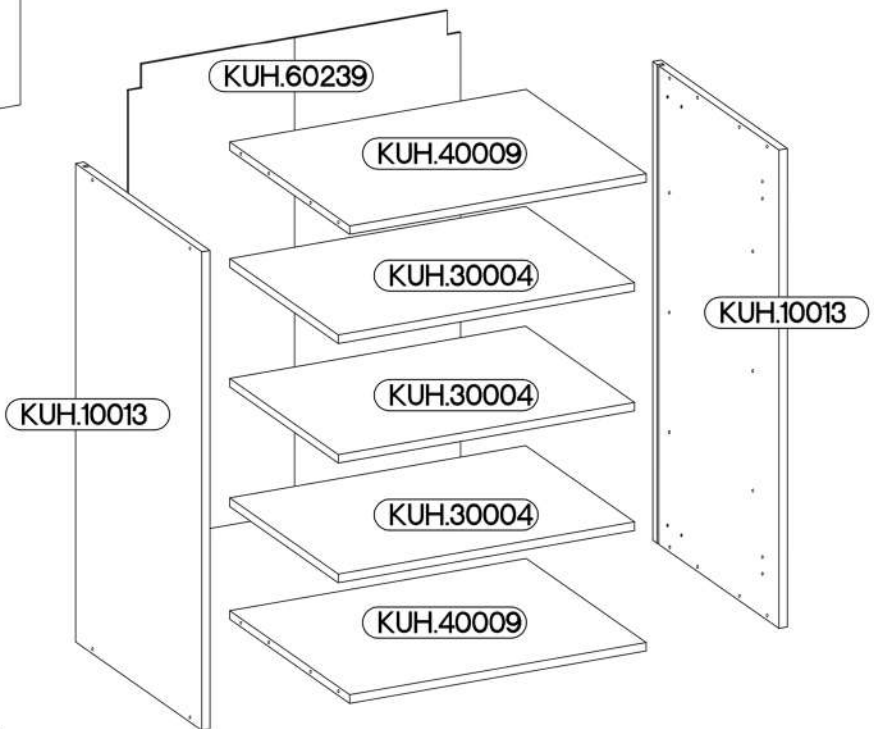
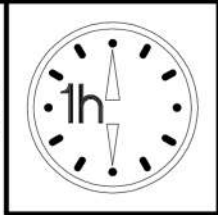

KUH.10013 x2	900x290x16
KUH.30004 x3	566x250x16
KUH.40009 x2	567x276x16
KUH.60239	896x585x2,5

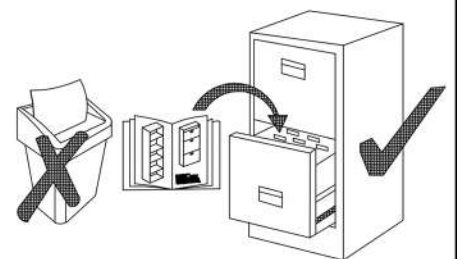
 A 8	 B 8	 E1 8	 HG 2	 P5 4	 P7 8-10	 P8 4
 J 12	 K 2	 O 1				



1

 +8x30mm A	 +4.0x30mm P8	 K
8	4	2

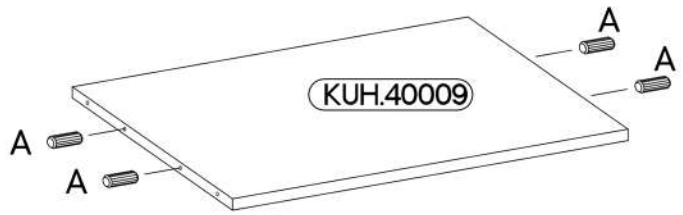
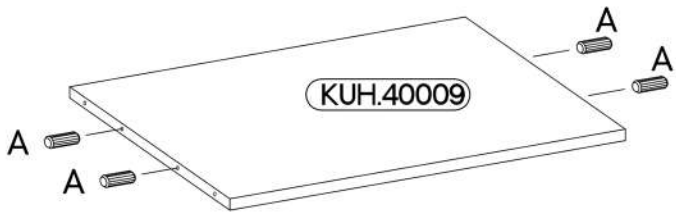
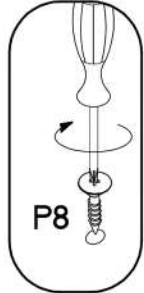
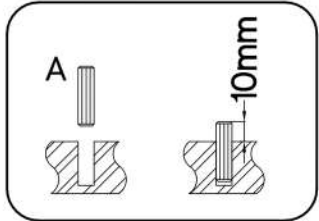
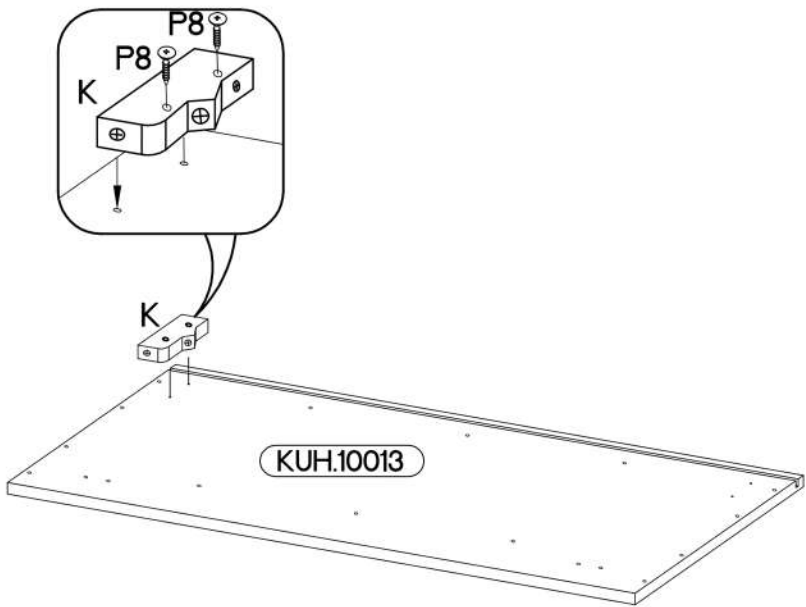
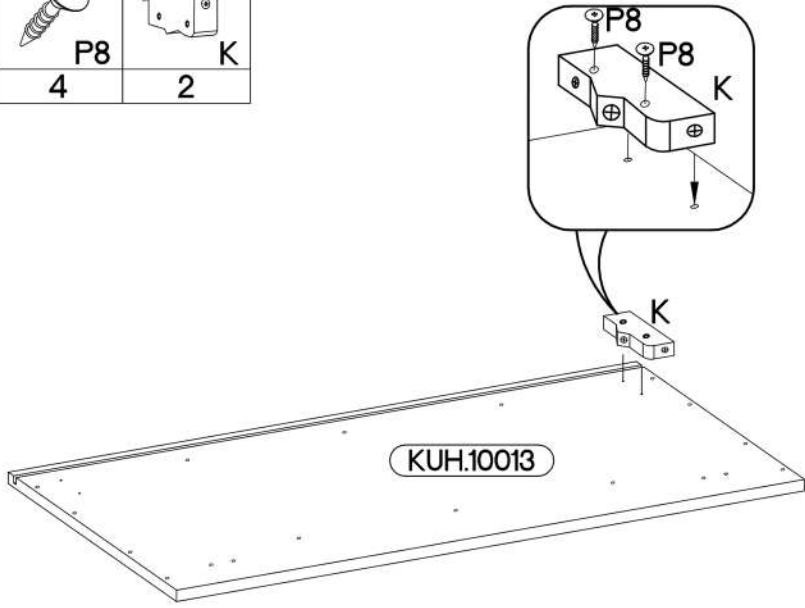
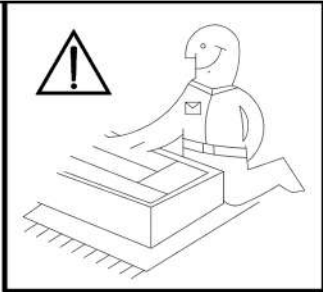

2

6,4 x 50mm

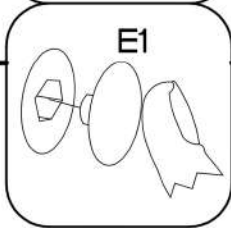
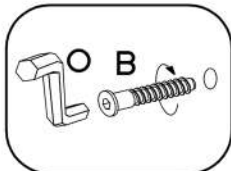
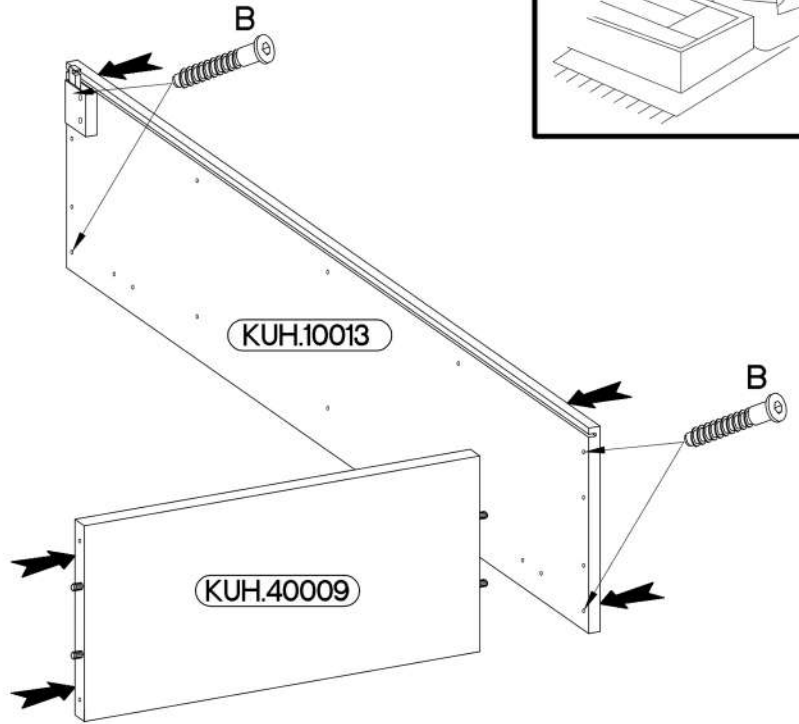
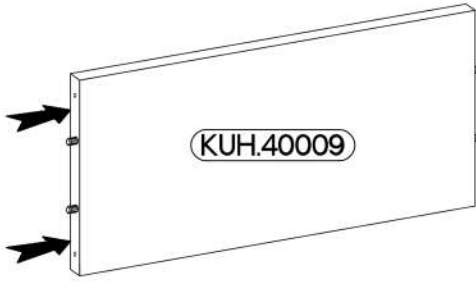
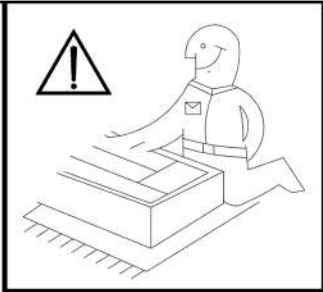
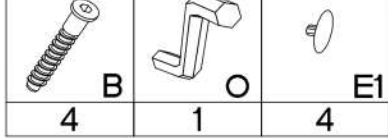

3

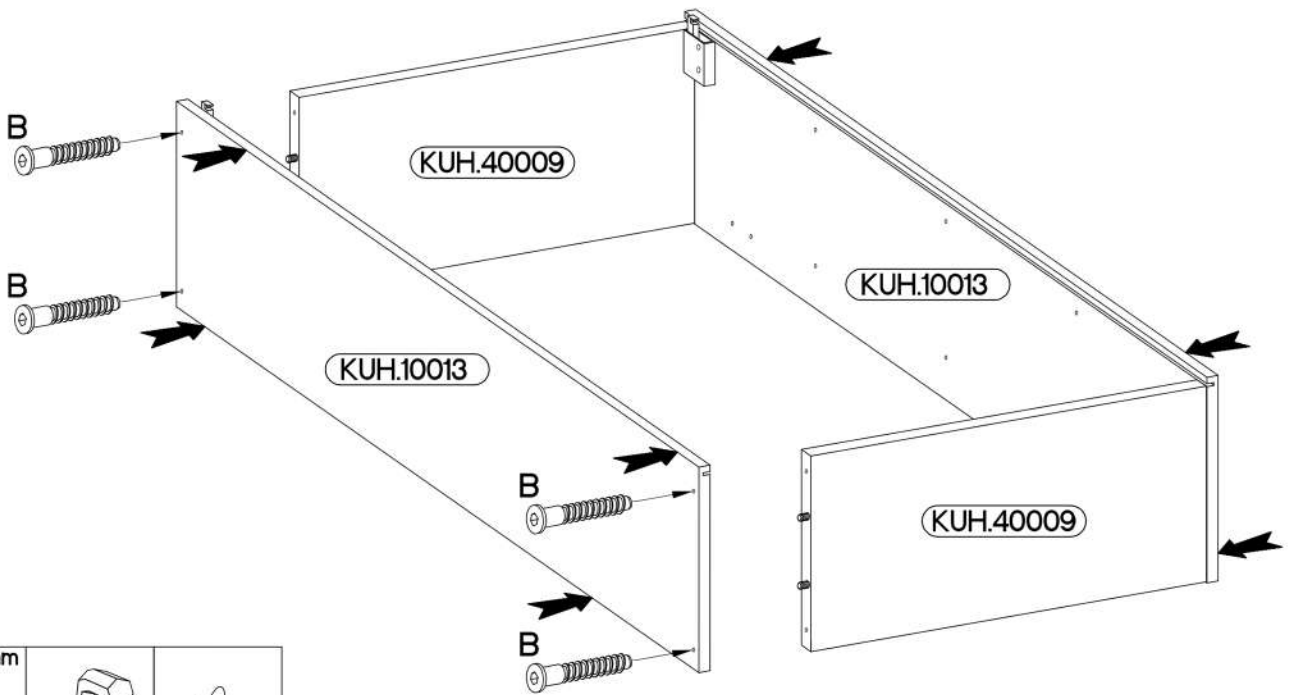

6,4 x 50mm

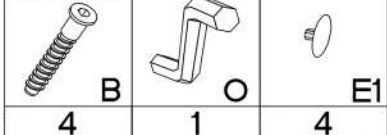

4

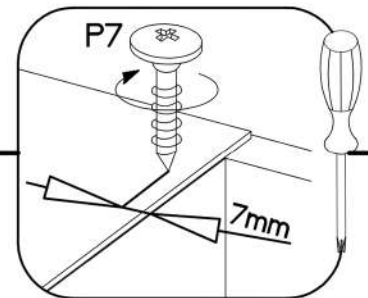
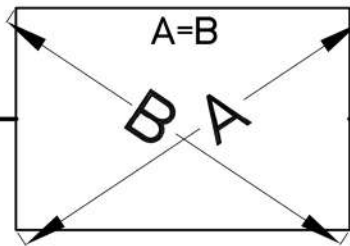
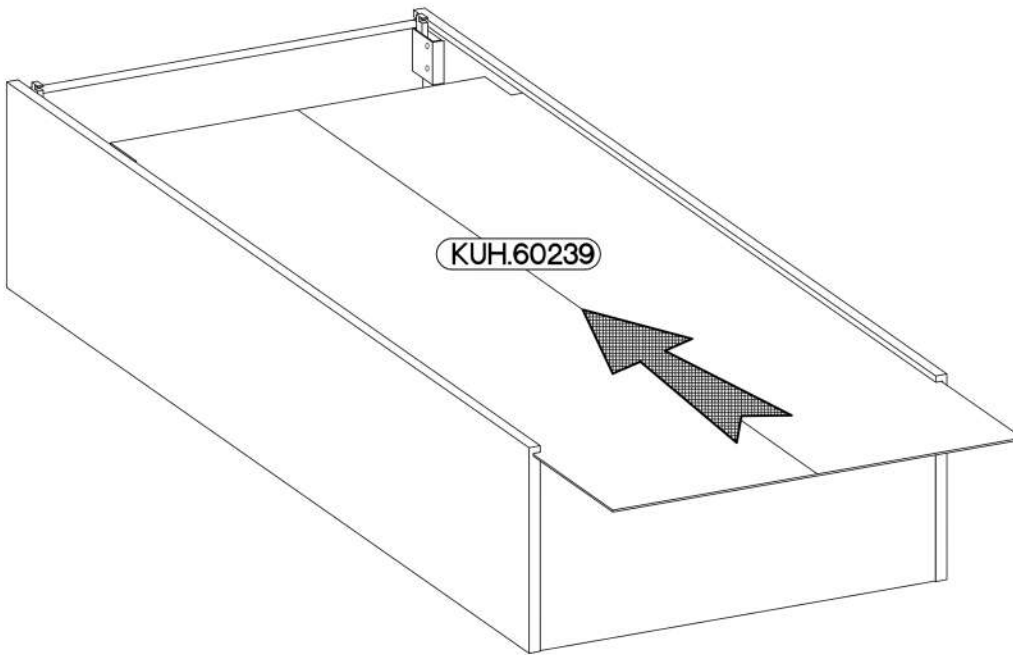
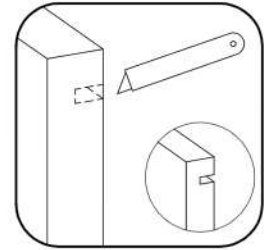
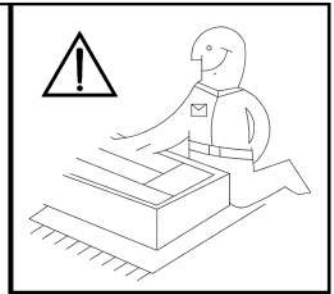

5

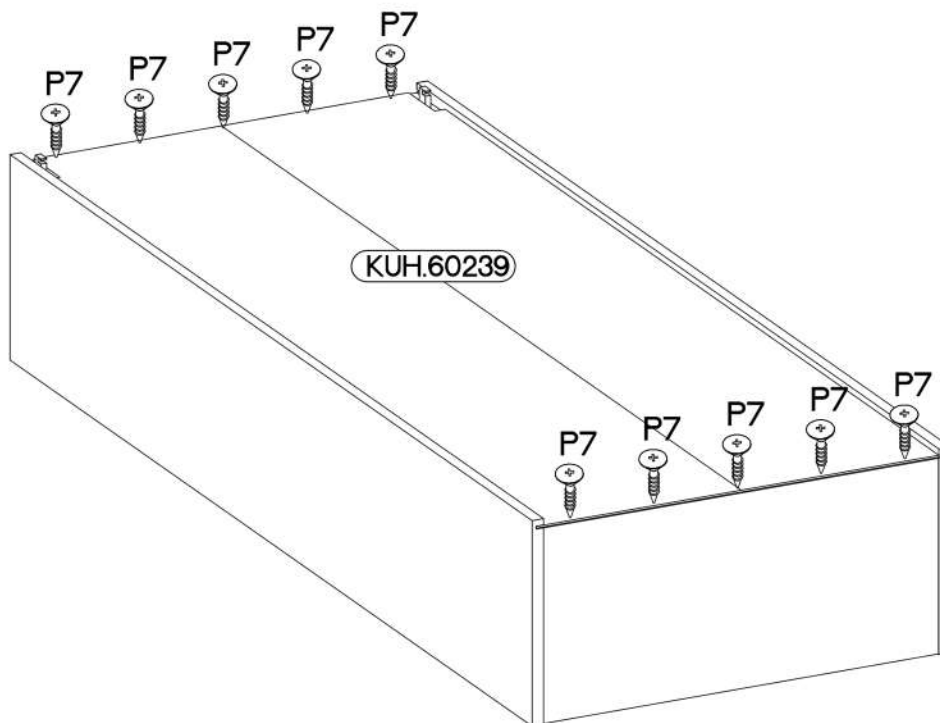
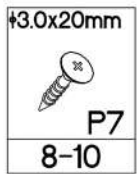

6

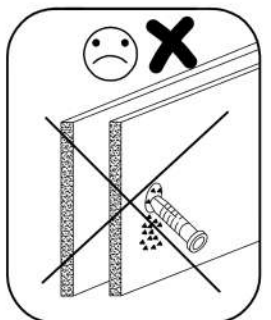
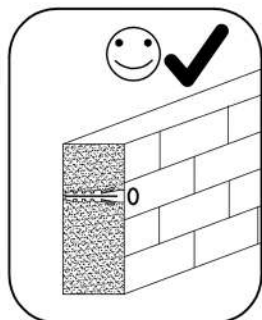
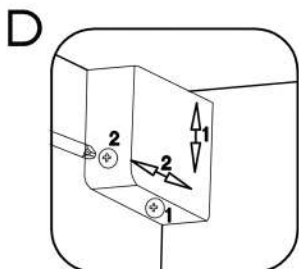
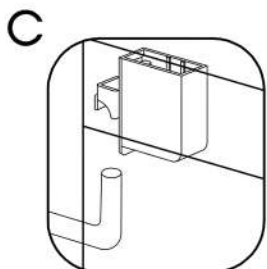
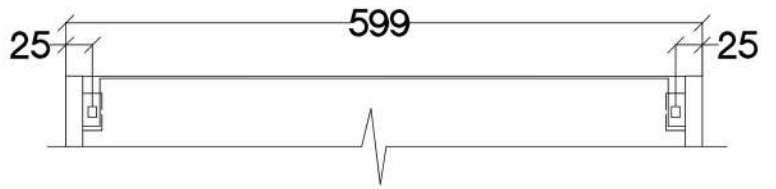
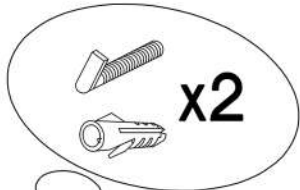
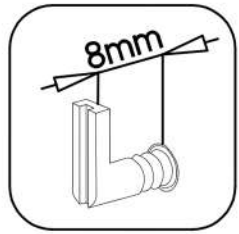
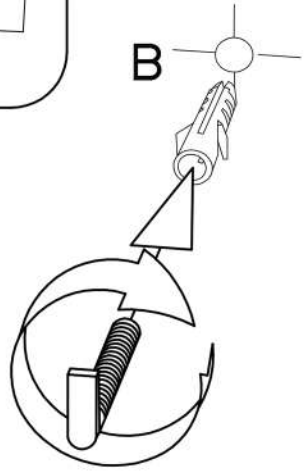
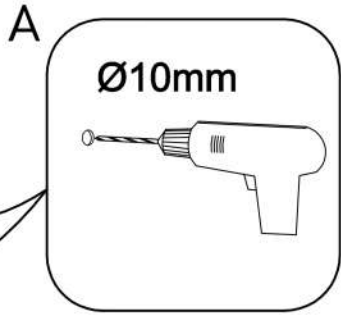
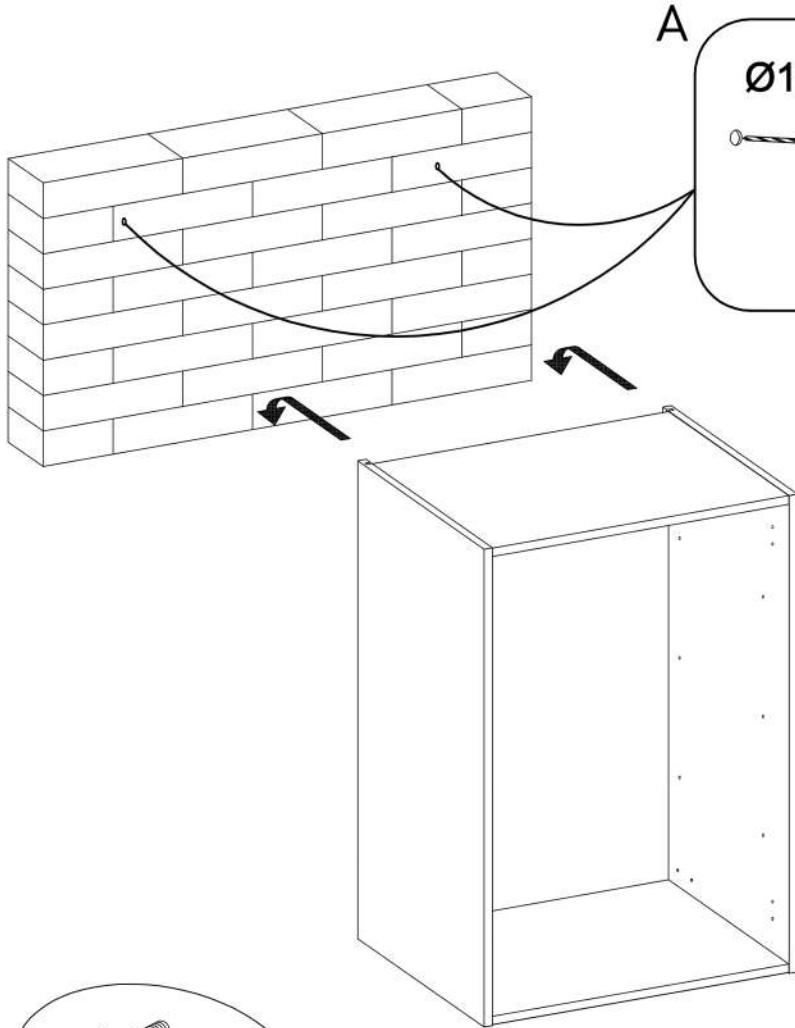
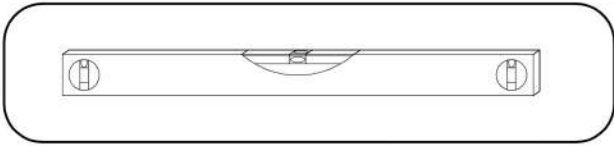

7

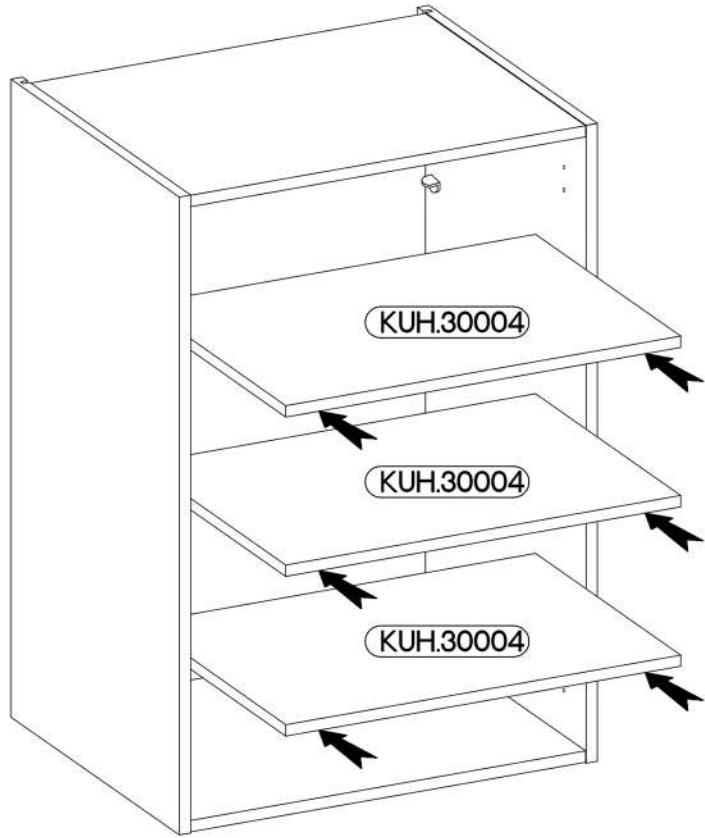
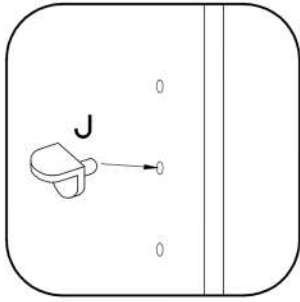
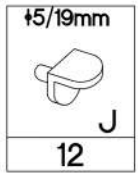

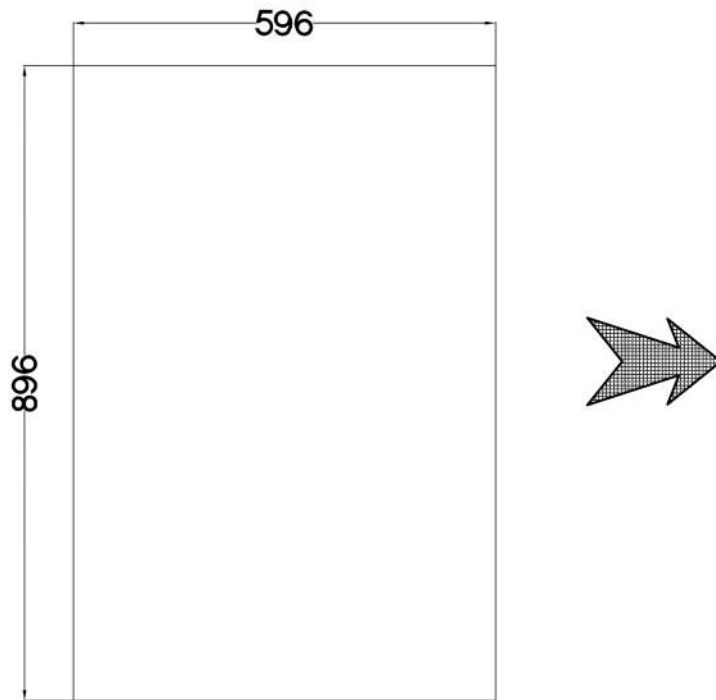

8

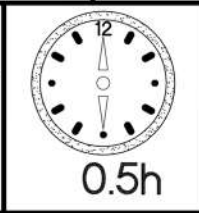
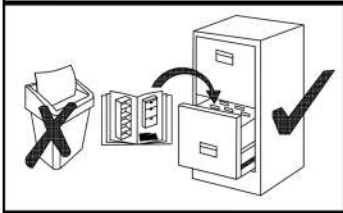
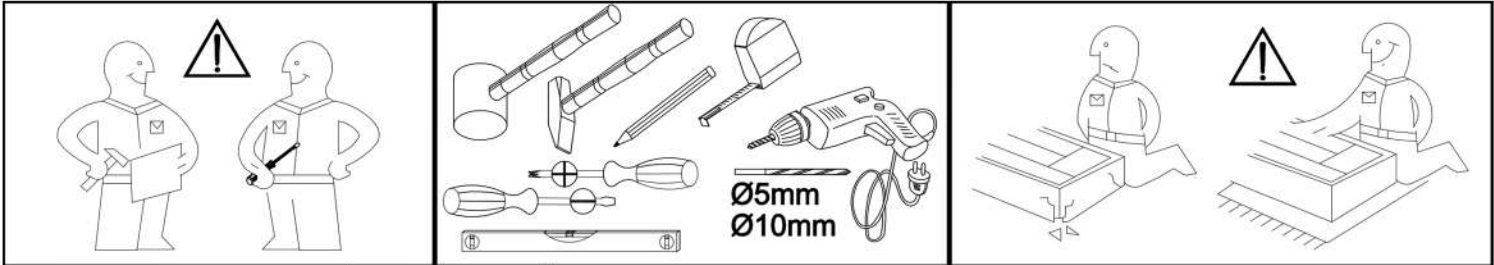

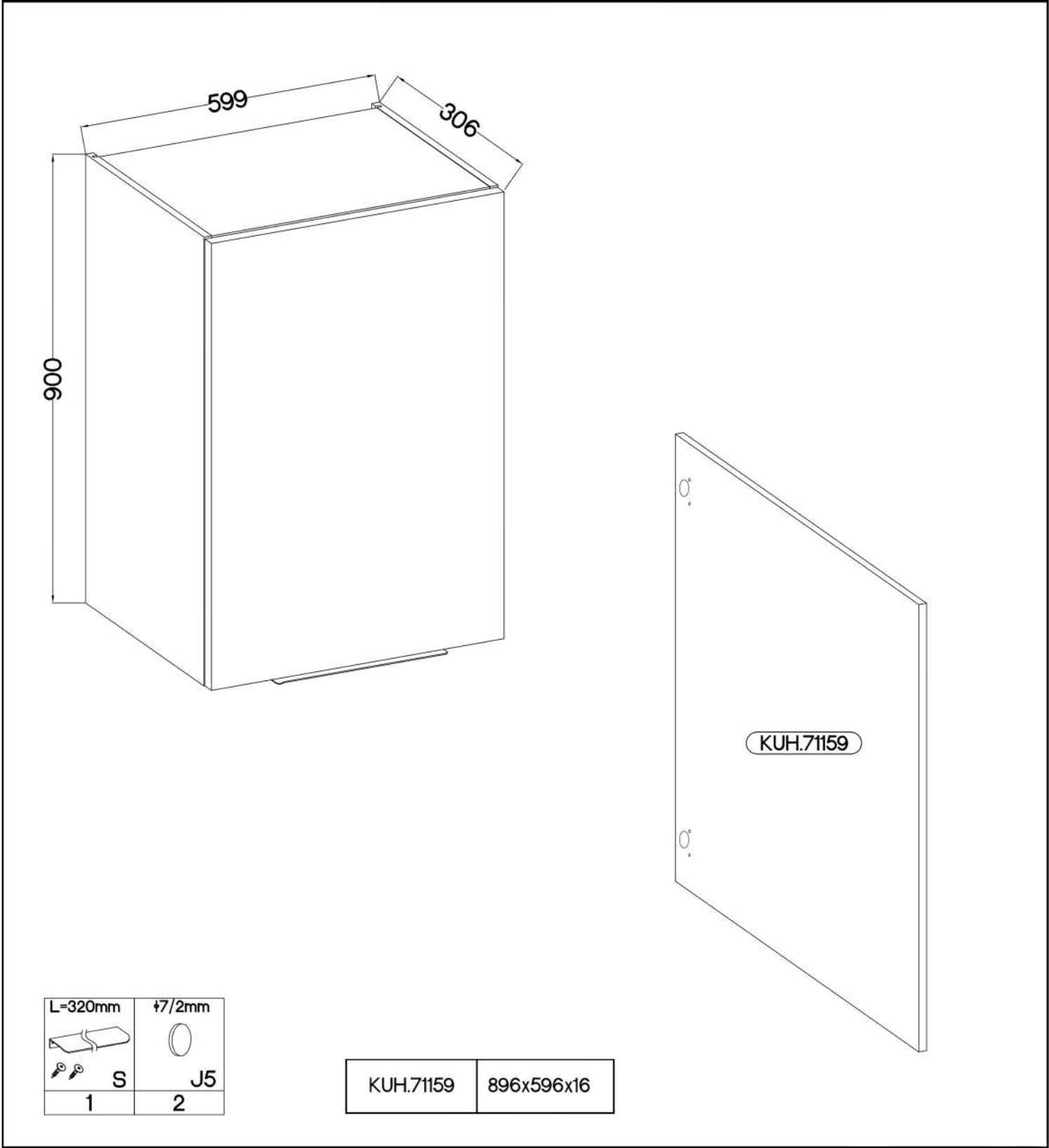
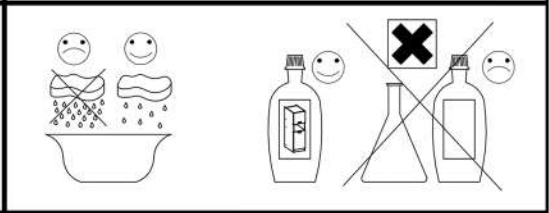

896x596



L=320mm	±7/2mm
	
S	J5
1	2

KUH.71159	896x596x16
-----------	------------

1

$\pm 35/0\text{mm}$ [CD] HG	$\pm 3.5 \times 13\text{mm}$ P5	$\pm 7/2\text{mm}$ J5
2	4	2

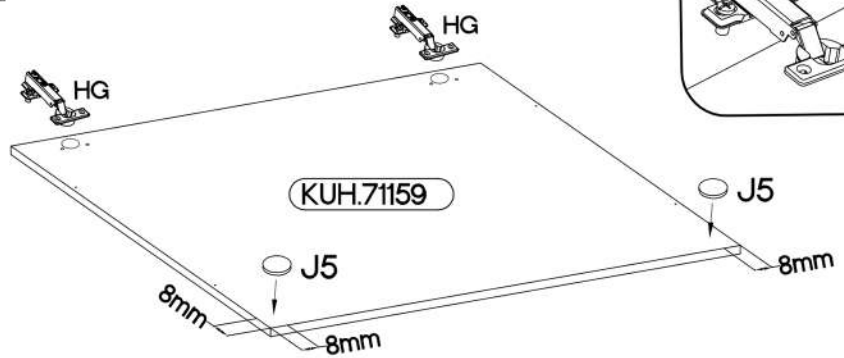
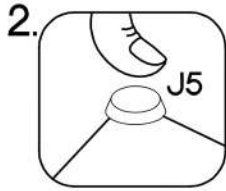
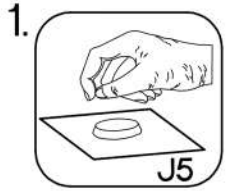

2

L=320mm
S
1

