

# FRISBO 60 G-72 1F

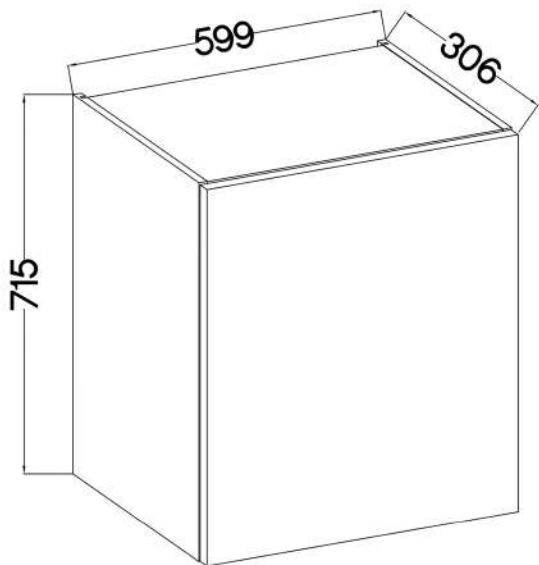

KUH.30004  
KUH.40009

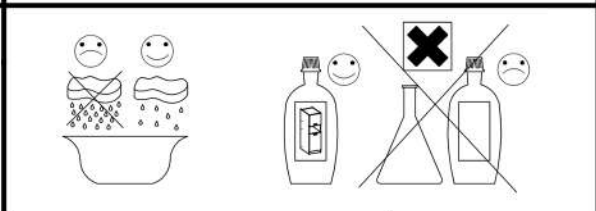

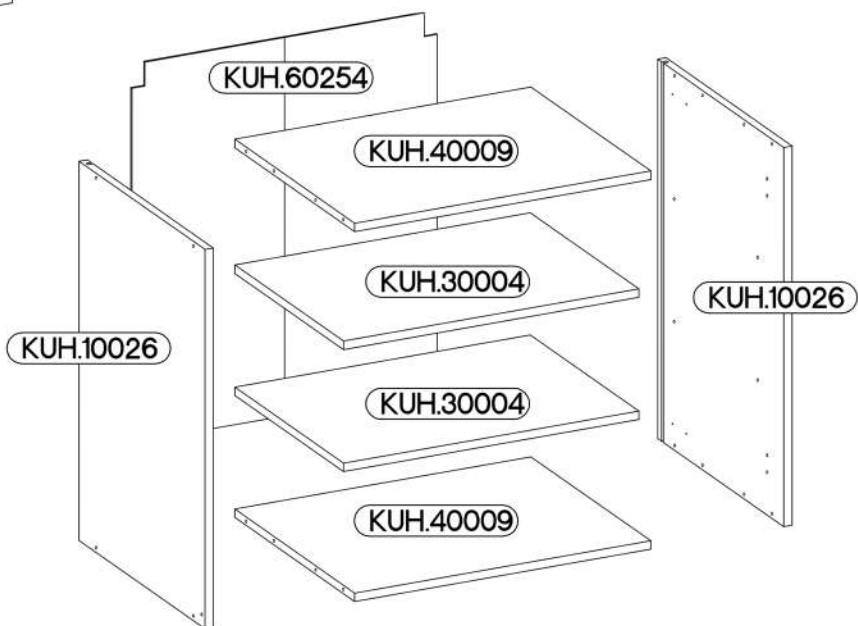
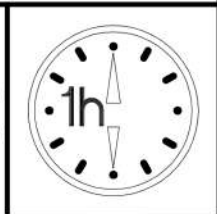

KUH.10026 x2	715x290x16
KUH.30004 x2	566x250x16
KUH.40009 x2	567x276x16
KUH.60254	713x585x2,5

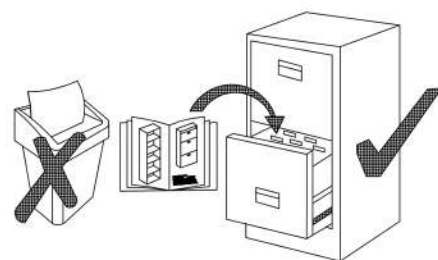
 A 8	 B 8	 E1 8	 HG 2	 P5 4	 P7 8-10	 P8 4
 J 8	 K 2	 O 1	 P5 4	 P7 8-10	 P8 4	



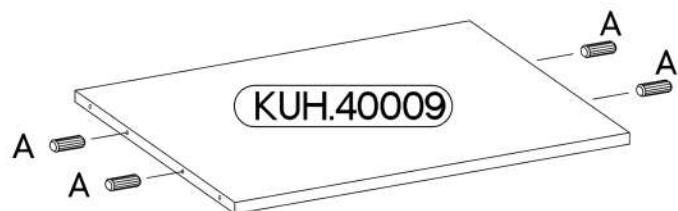
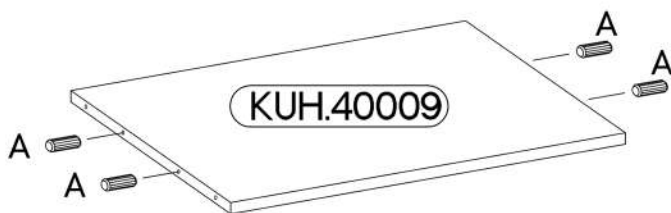
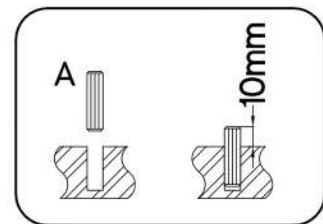
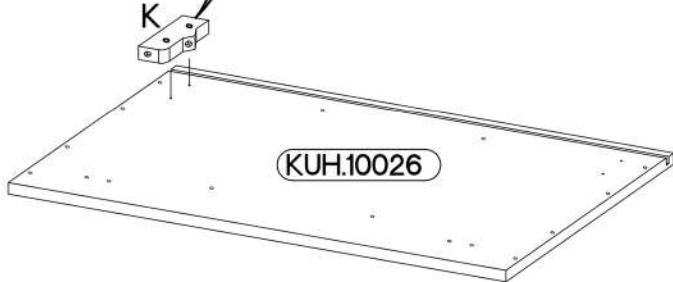
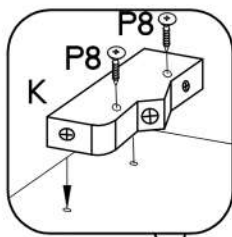
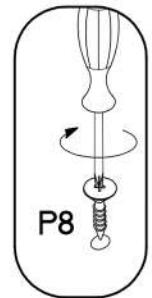
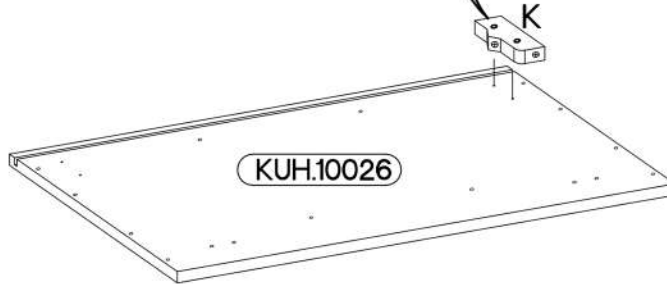
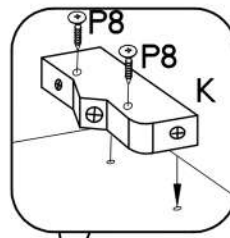
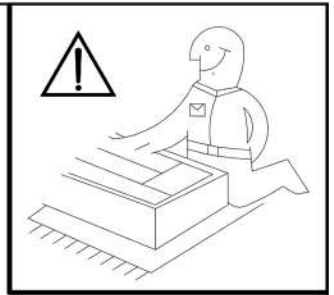

1

 +8x30mm A	 +4.0x30mm P8	 K
8	4	2





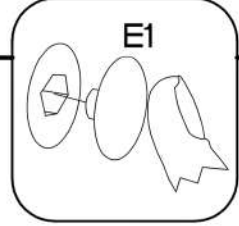
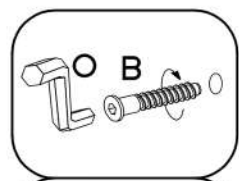
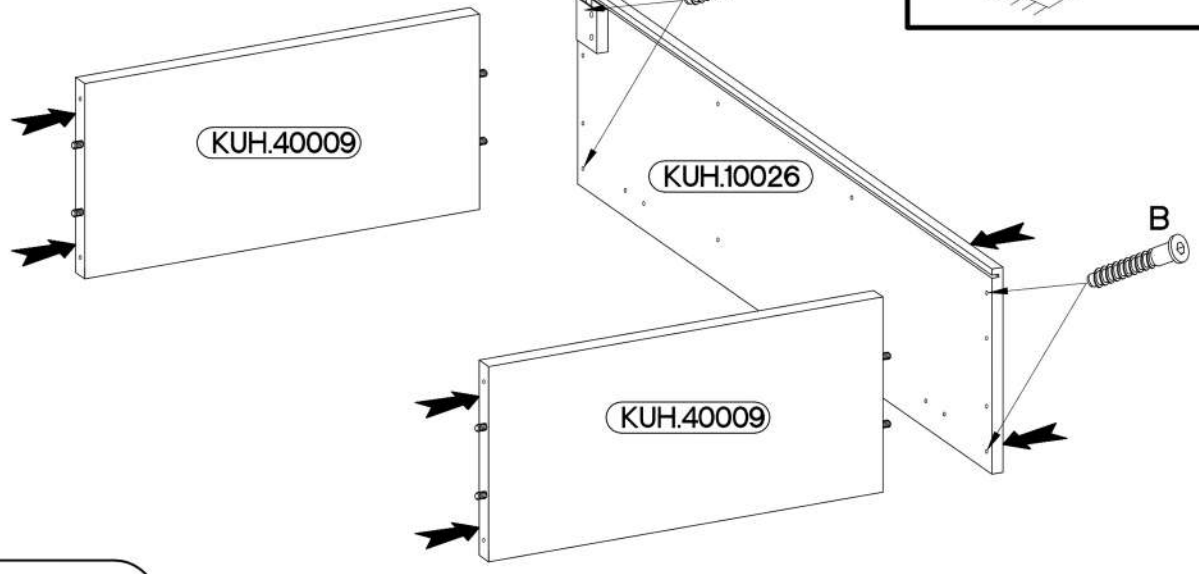
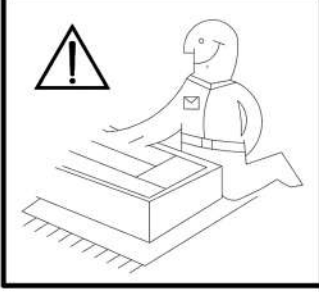

2

6,4 x 50mm		
		
B	O	E1
4	1	4

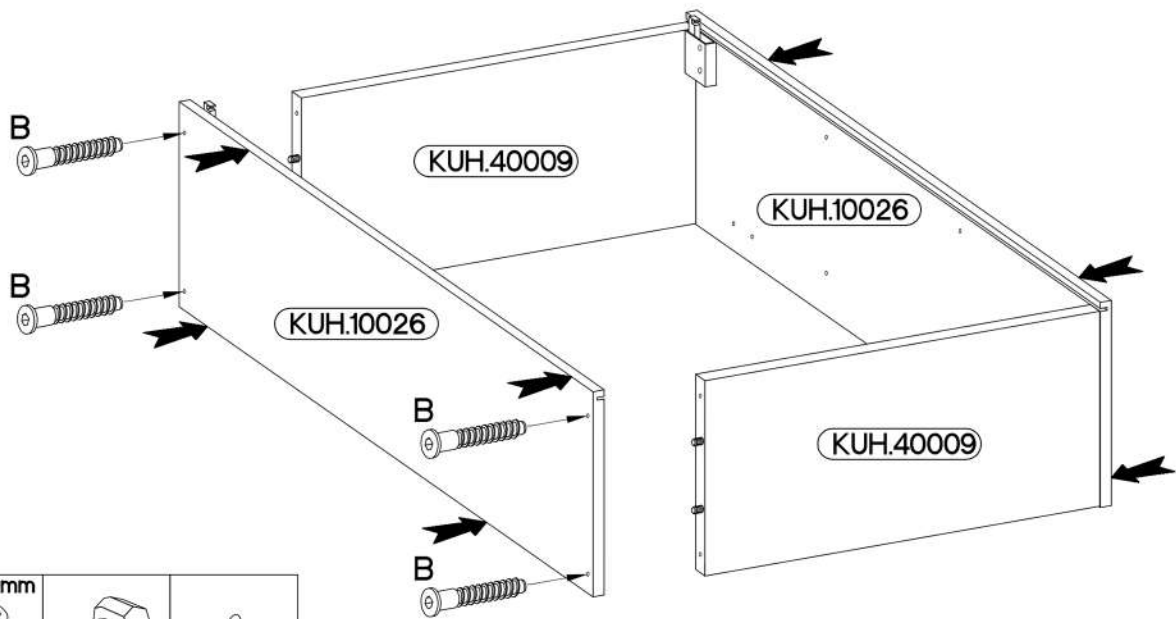

3



6,4 x 50mm		
		
B	O	E1
4	1	4

4

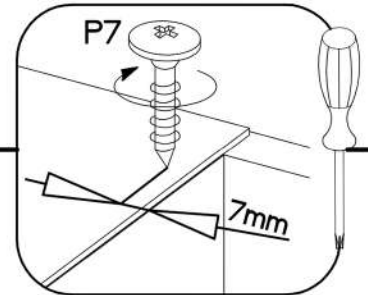
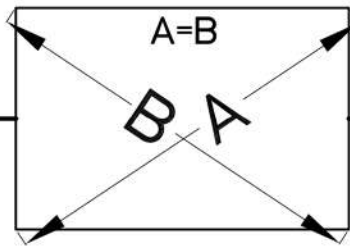
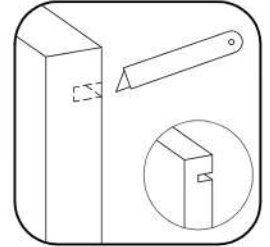
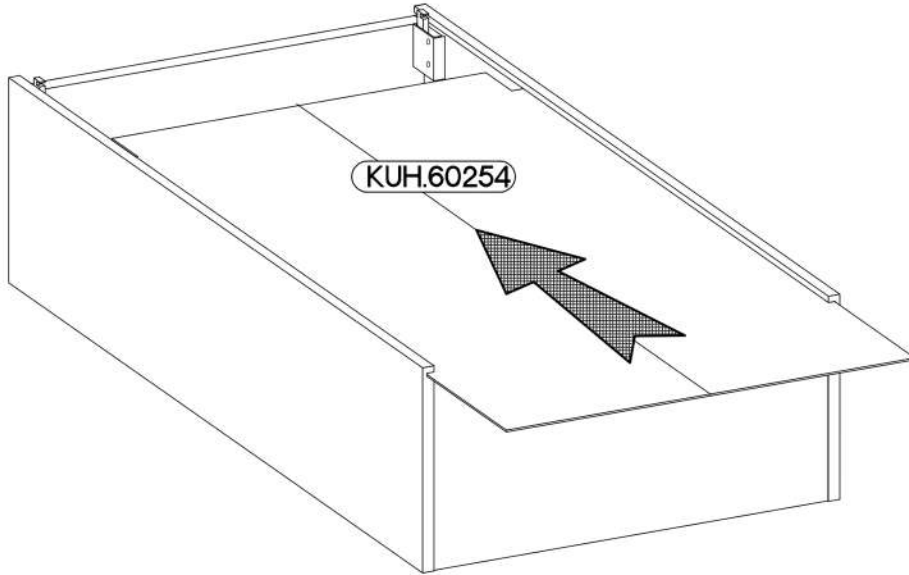
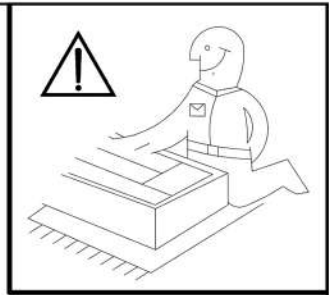

5

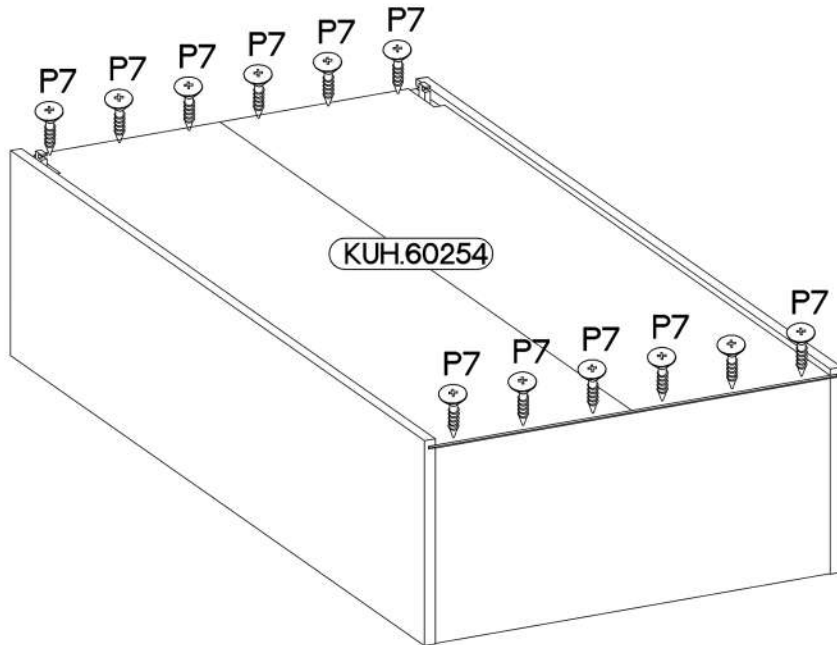
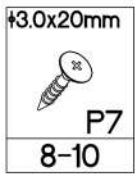

6

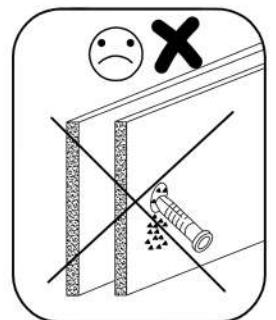
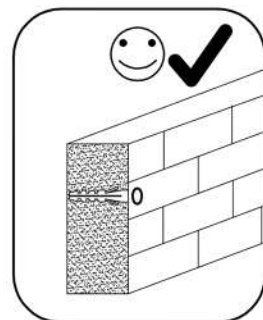
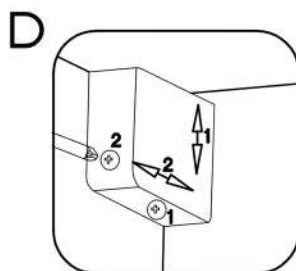
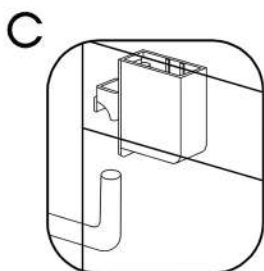
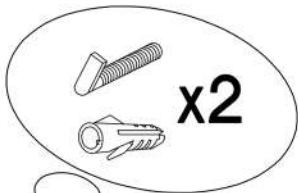
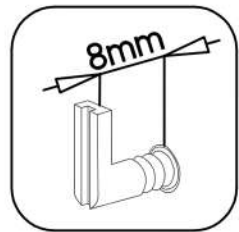
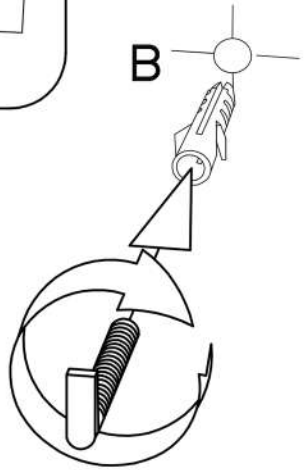
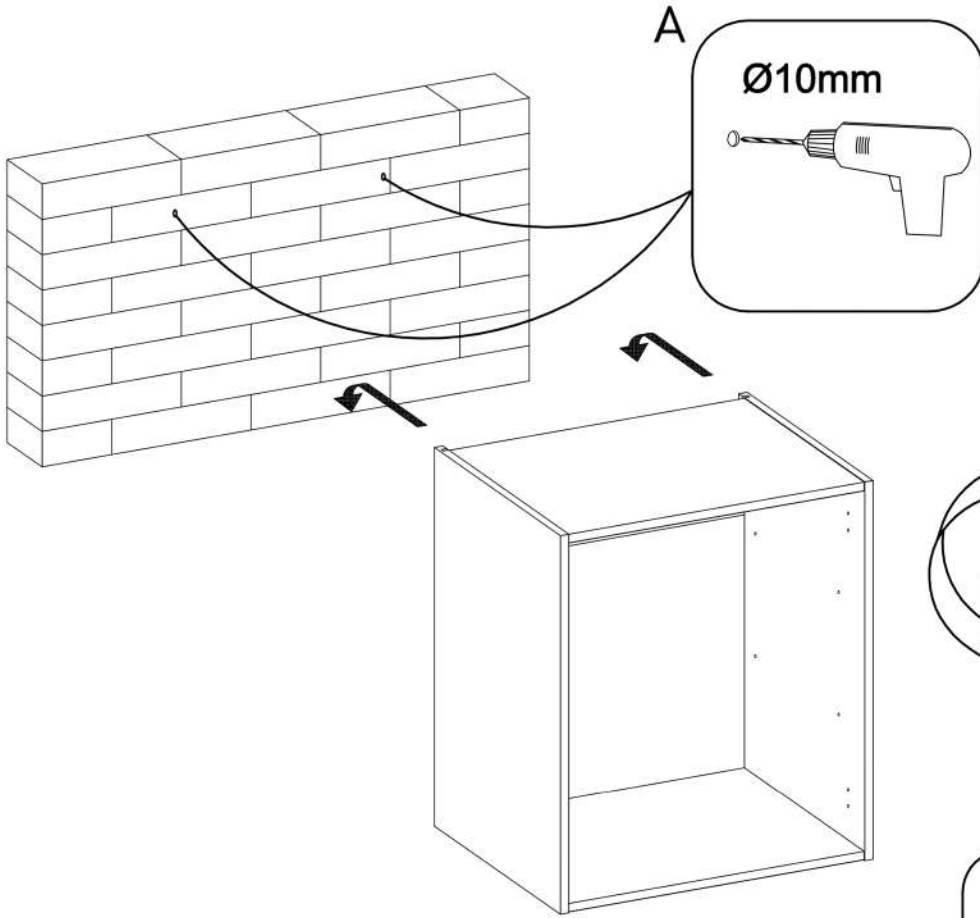
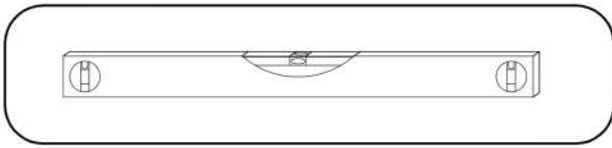

7

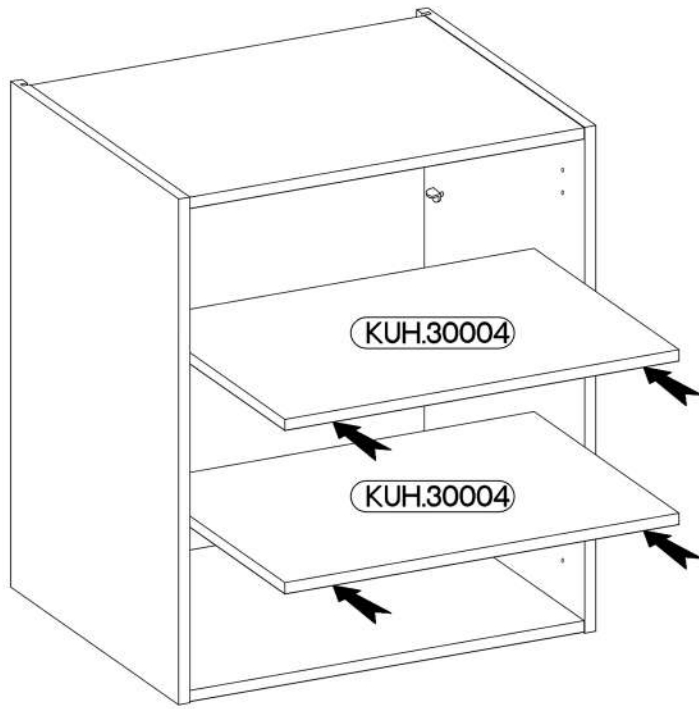
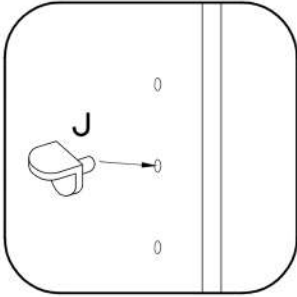
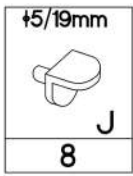

8

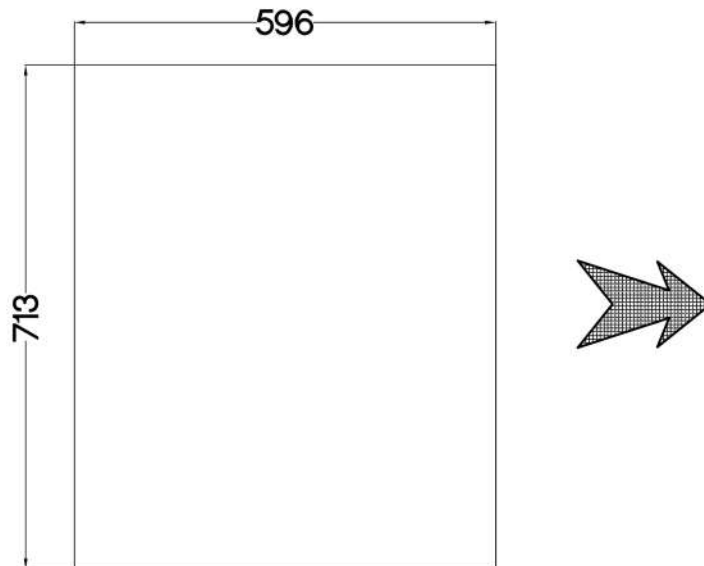

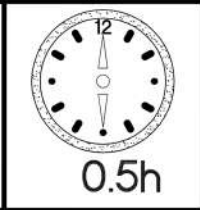
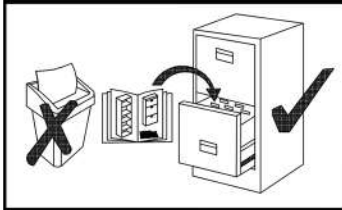
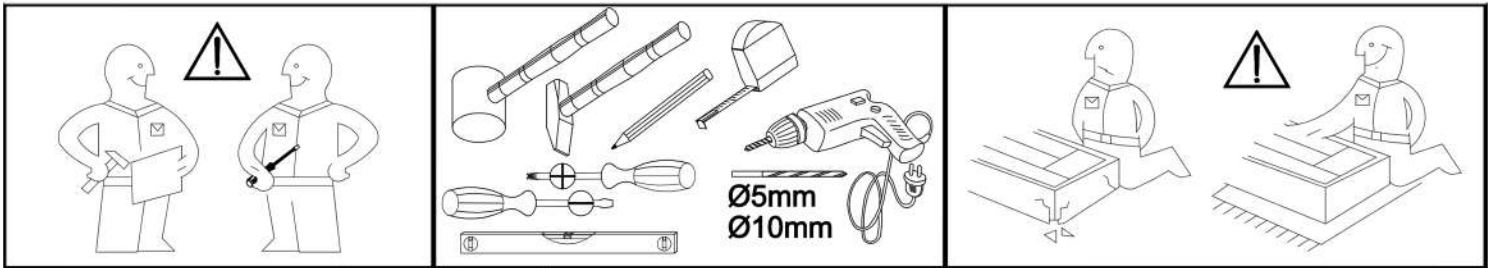

**713x596**

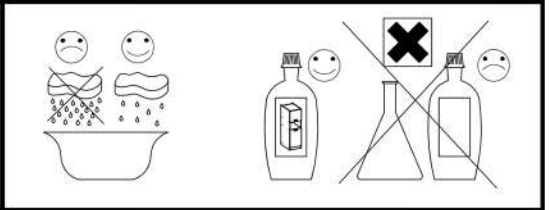

**60 D 1F BB**

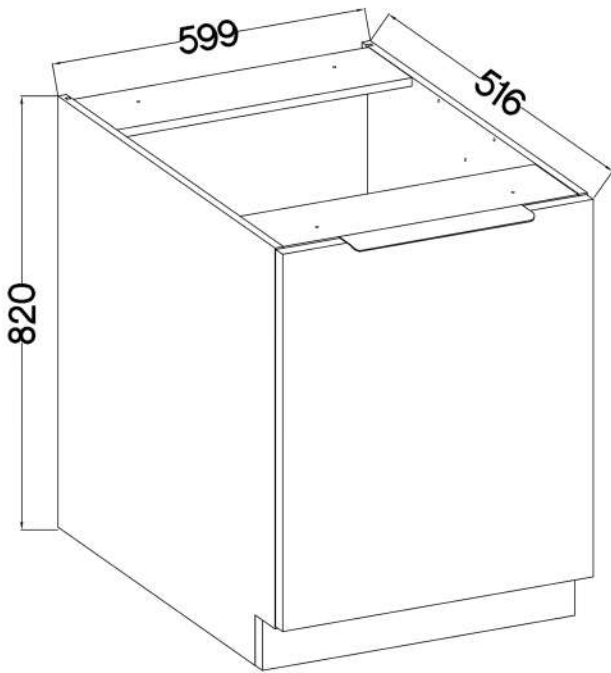

**60 G-72 1F**

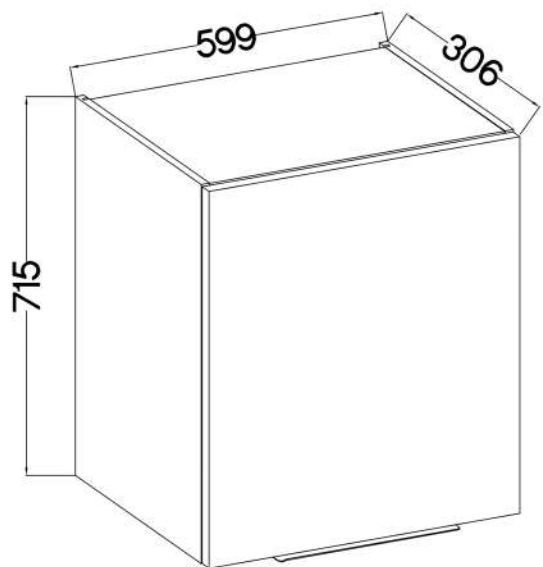



L=320mm	+7/2mm
S	J5
1	2

KUH.71151	713x596x16
-----------	------------

# 1

# 60 D 1F BB

±35/0mm	±3.5x13mm	±7/2mm
 HG	 P5	 J5
2	4	2

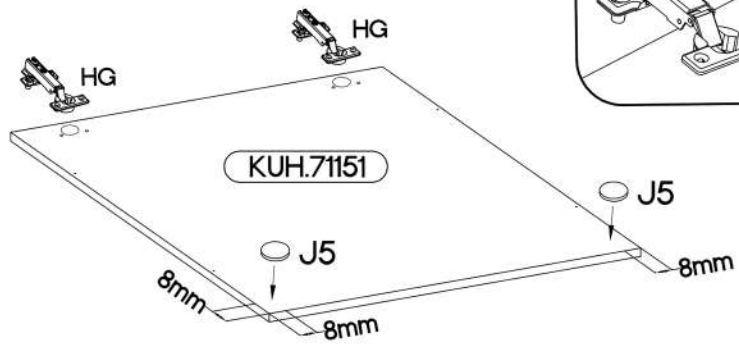
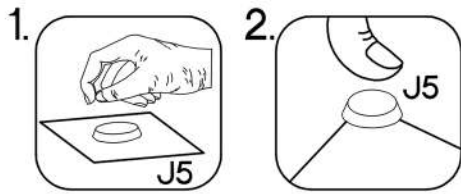
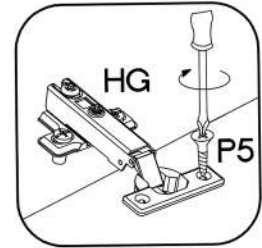

# 2

L=320mm
 S
1

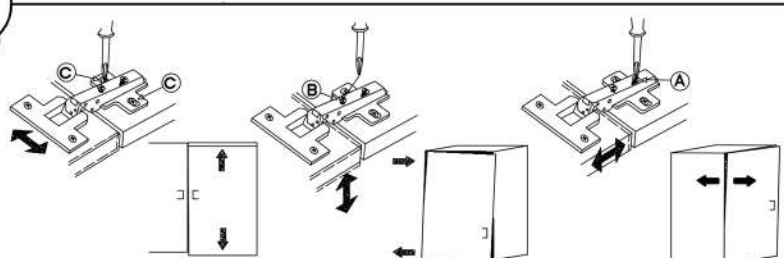
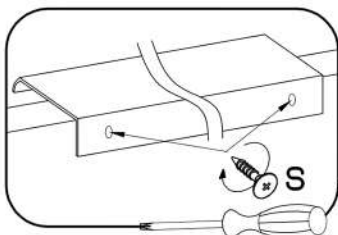
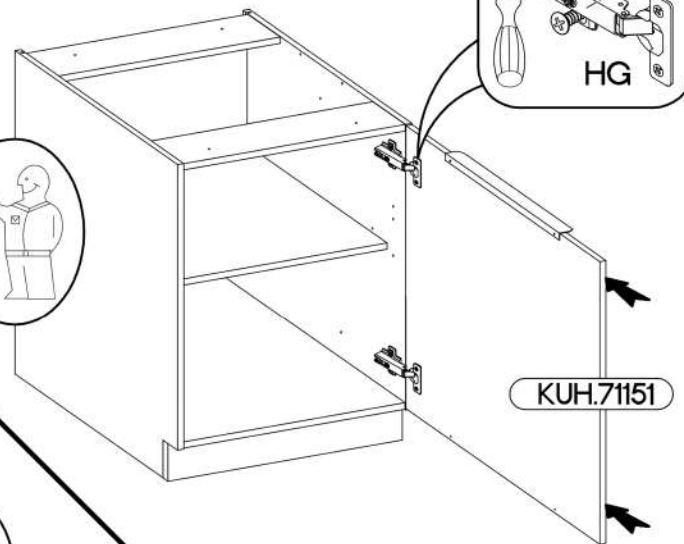
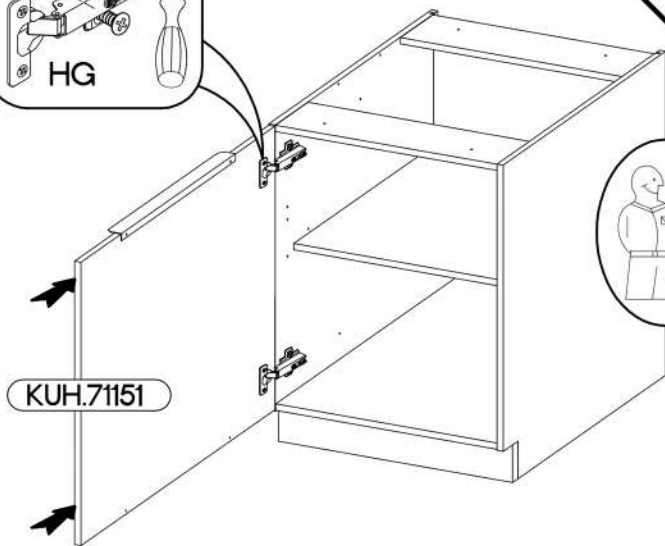
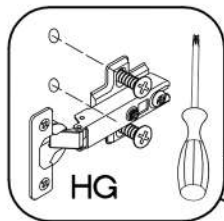
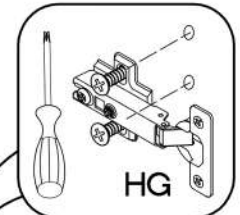

3

60 G-72 1F

