

# FRISBO 80 G-108 2F

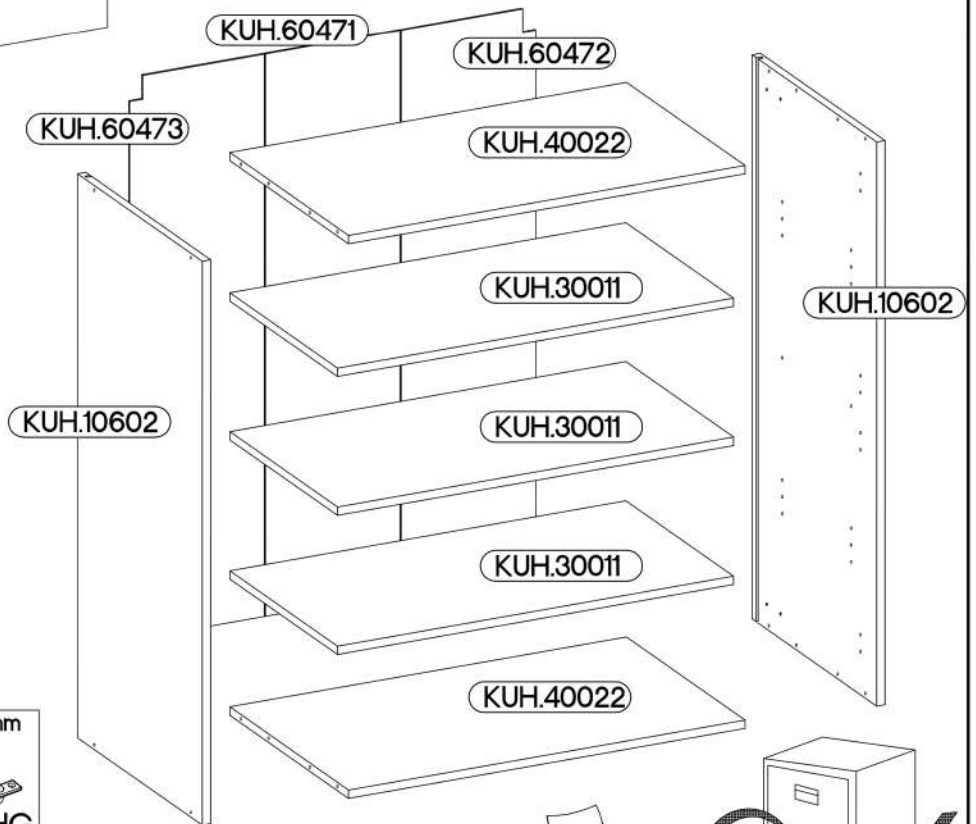

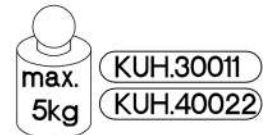
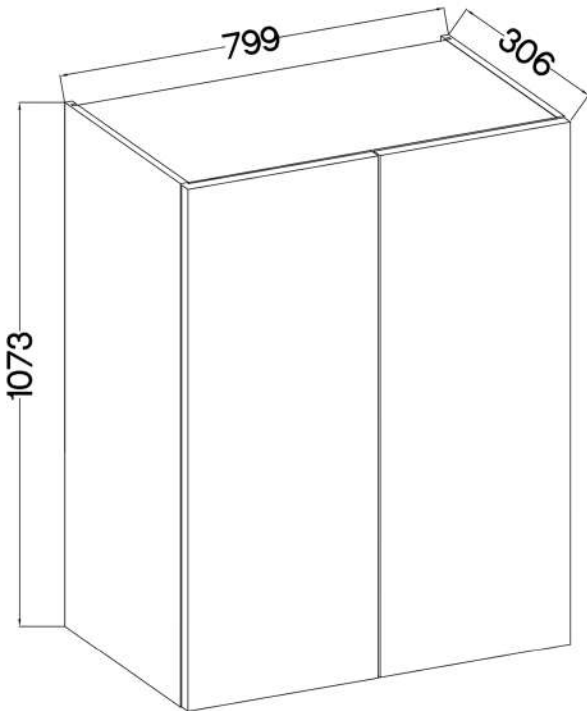
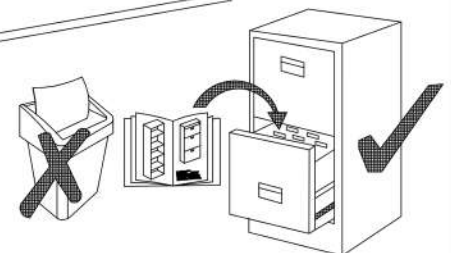

|              |              |
|--------------|--------------|
| KUH.10602 x2 | 1073x290x16  |
| KUH.30011 x3 | 766x250x16   |
| KUH.40022 x2 | 767x276x16   |
| KUH.60471    | 1070x260x2,5 |
| KUH.60472    | 1070x260x2,5 |
| KUH.60473    | 1070x260x2,5 |

|              |            |             |             |                    |                 |                 |
|--------------|------------|-------------|-------------|--------------------|-----------------|-----------------|
| <br>A<br>8   | <br>B<br>8 | <br>E1<br>8 | <br>HG<br>6 | <br>P5<br>12       | <br>P7<br>15-20 | <br>P8<br>4     |
| <br>J3<br>12 | <br>K<br>2 | <br>L1<br>2 | <br>O<br>1  | <br>L1-1038mm<br>2 | <br>P5<br>12    | <br>P7<br>15-20 |
| <br>J3<br>12 | <br>K<br>2 | <br>L1<br>2 | <br>O<br>1  | <br>P5<br>12       | <br>P7<br>15-20 | <br>P8<br>4     |



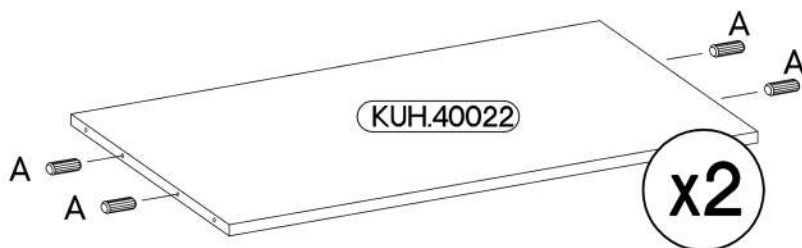
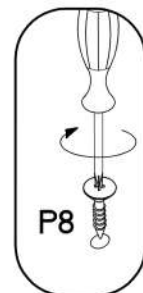
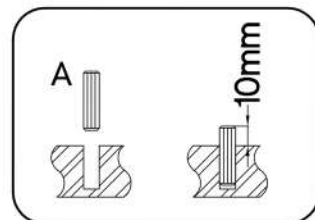
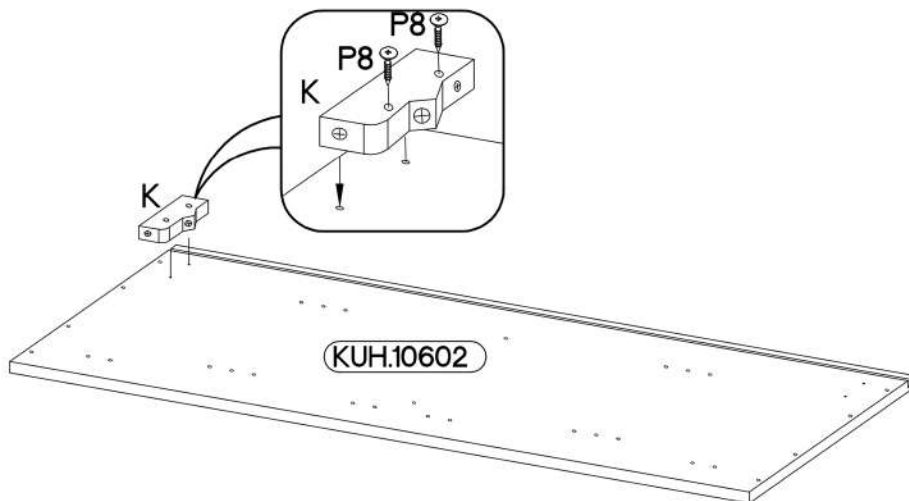
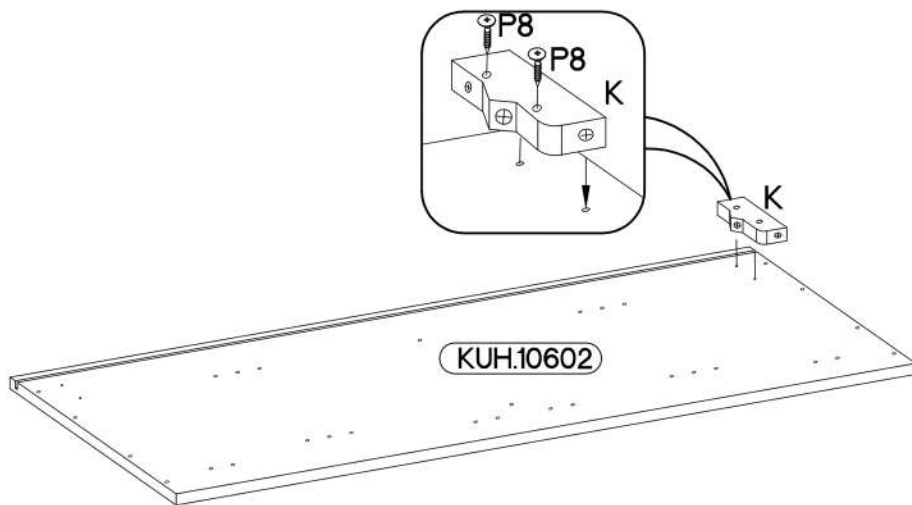
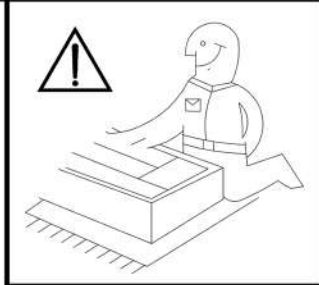

1

|   |  |  |
|---|--|--|
| $\pm 8 \times 30 \text{mm}$<br><br>A | $\pm 4.0 \times 30 \text{mm}$<br><br>P8 | <br>K |
| 8   | 4  | 2  |





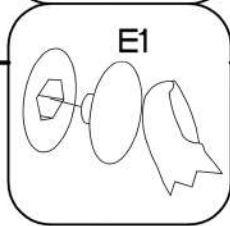
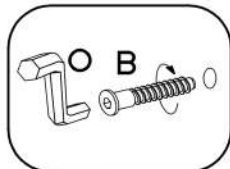
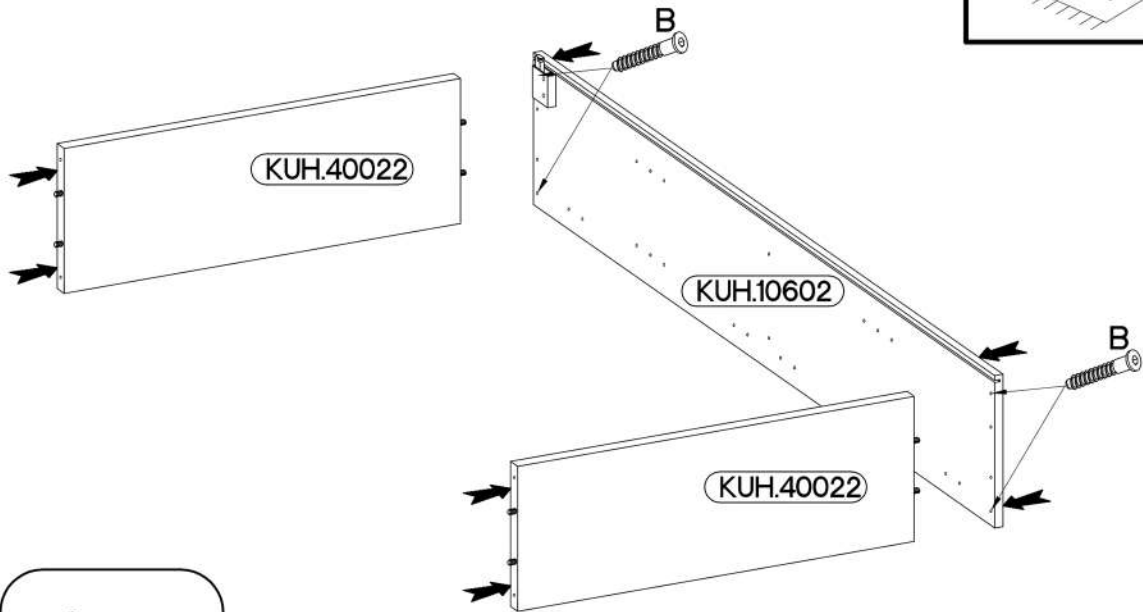
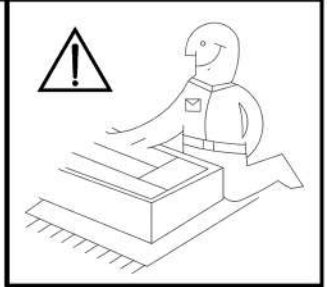

2

|   |   |   |
|---|---|---|
| 6,4 x 50mm  |   |   |
|  |  |  |
| B   | O   | E1  |
| 4   | 1   | 4   |

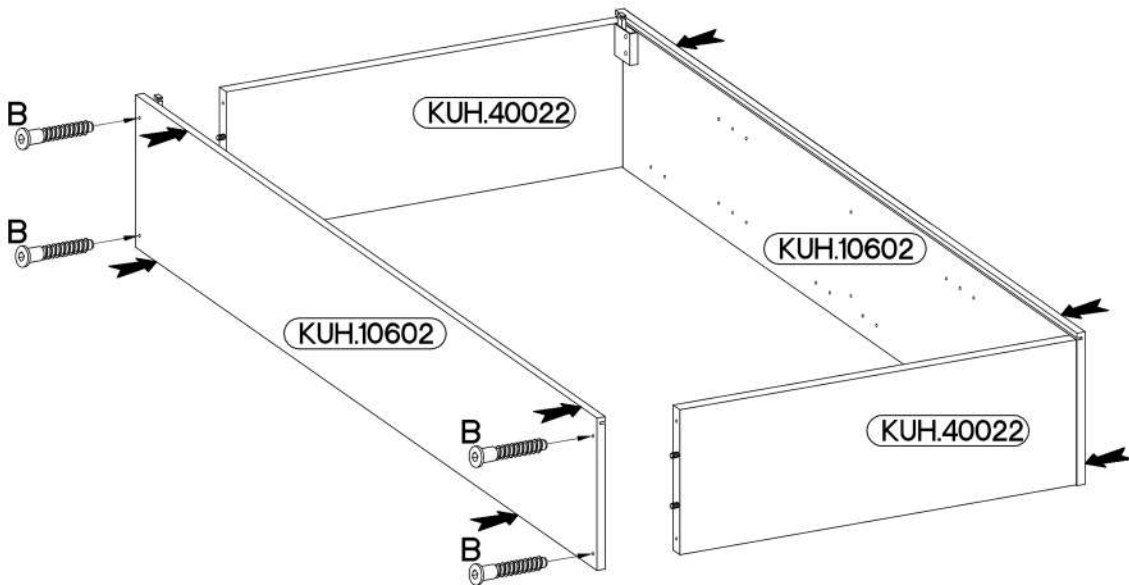

3



|   |   |   |
|---|---|---|
| 6,4 x 50mm  |   |   |
|  |  |  |
| B   | O   | E1  |
| 4   | 1   | 4   |

4

L1=1038mm

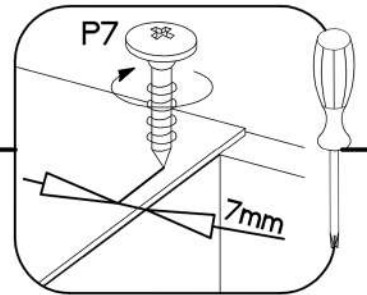
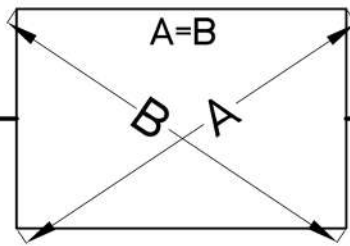
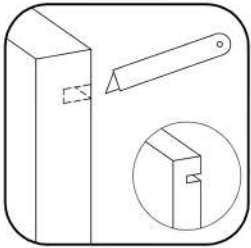
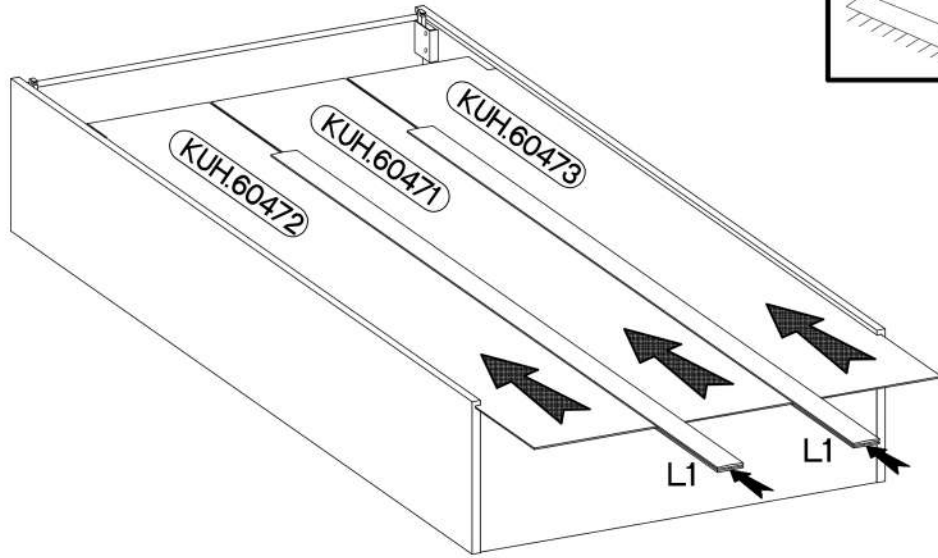
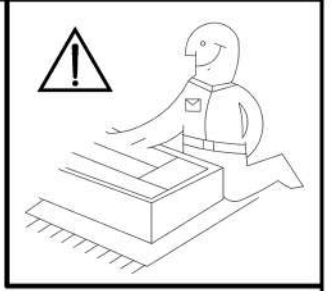
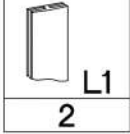

5

±3.0x20mm

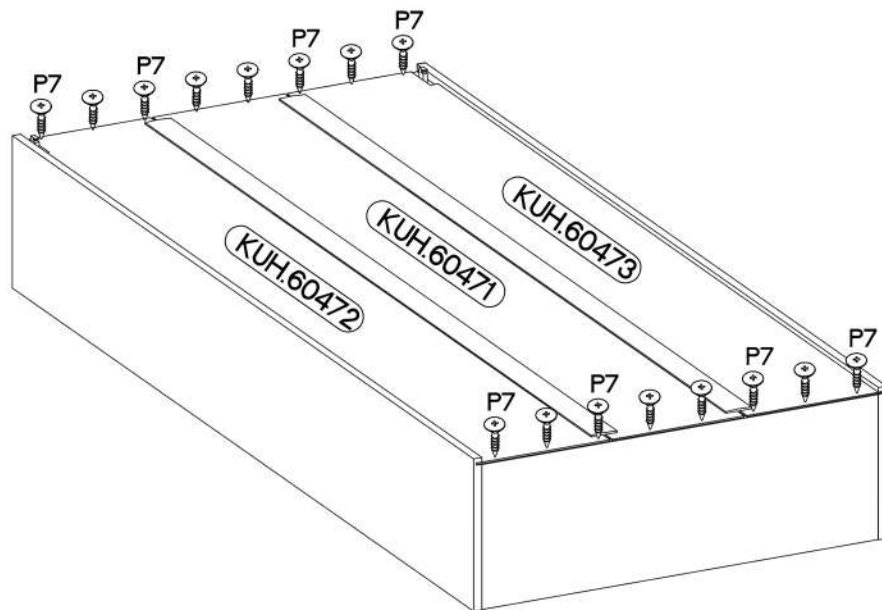
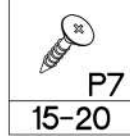

6

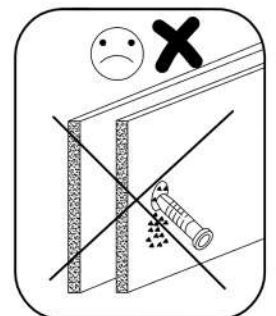
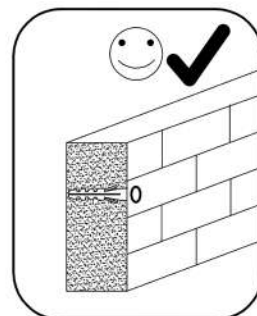
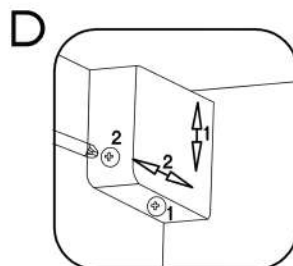
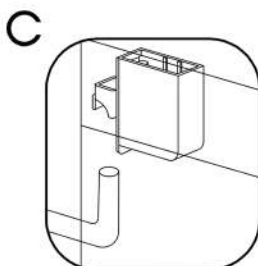
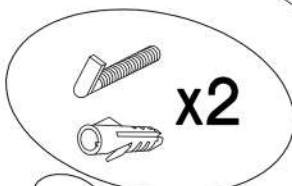
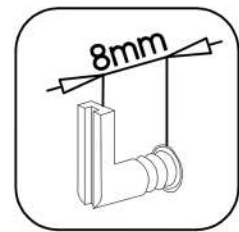
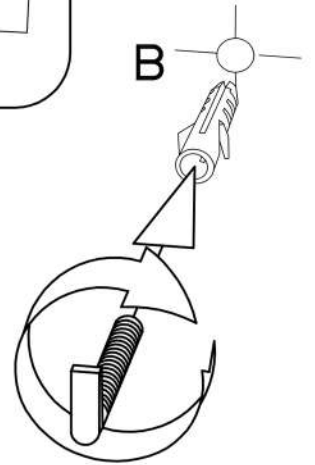
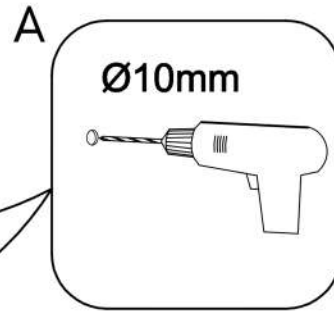
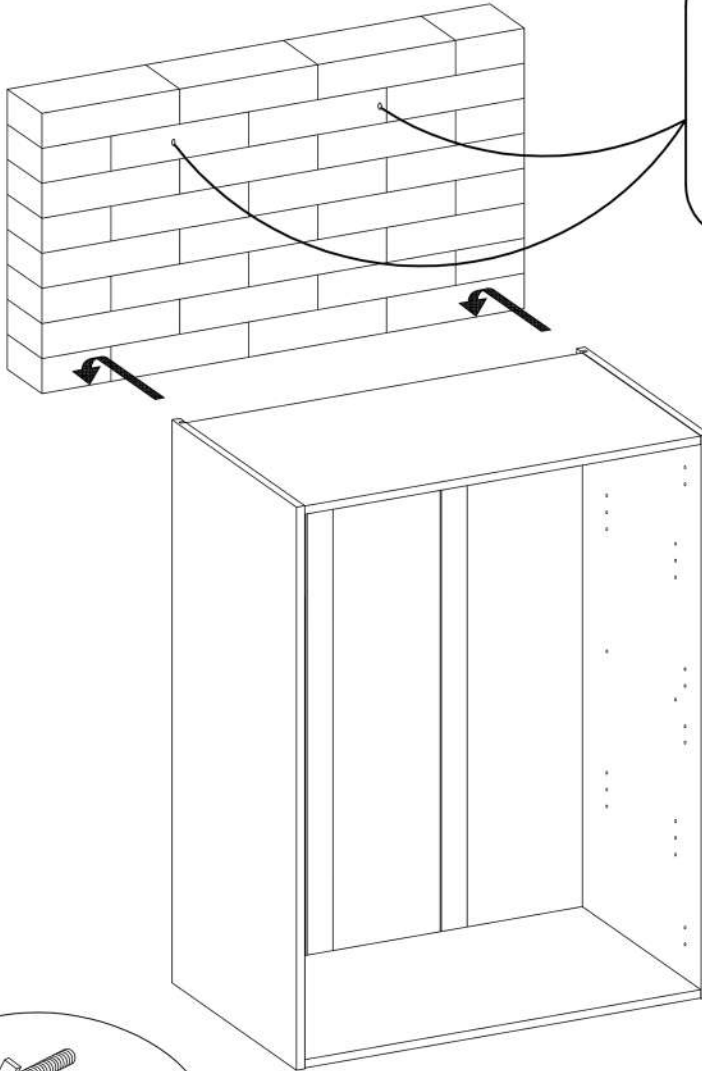
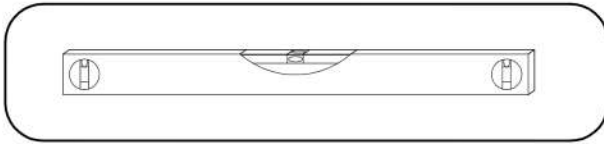

7

±5/16mm



J3

12

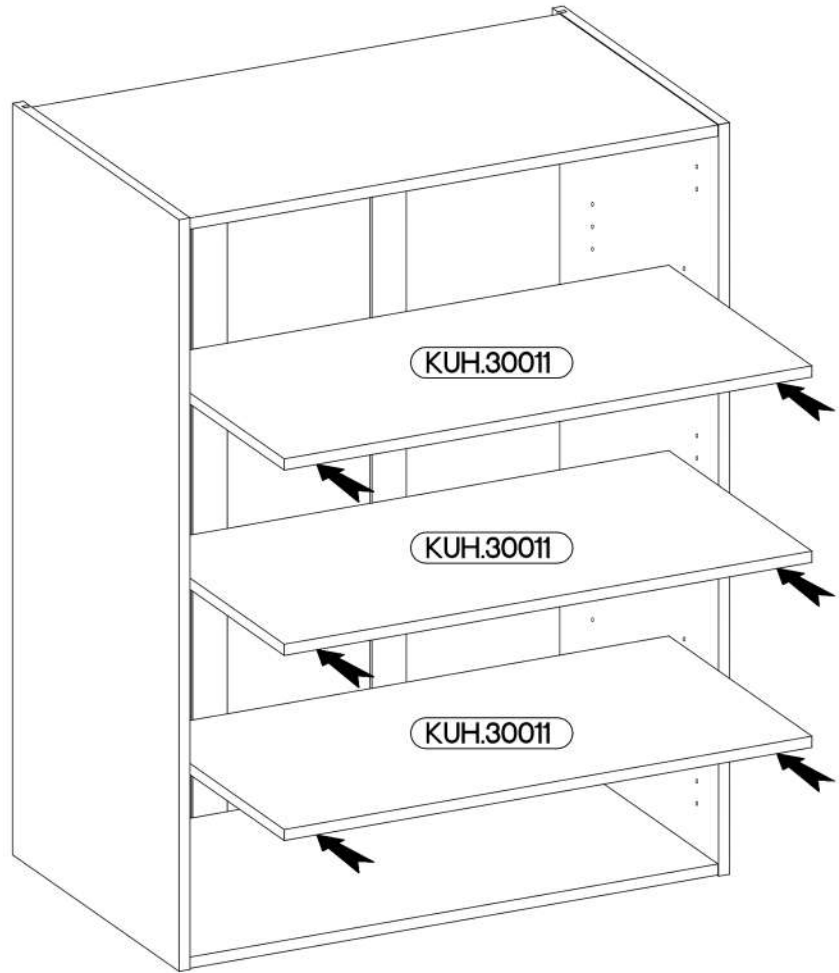
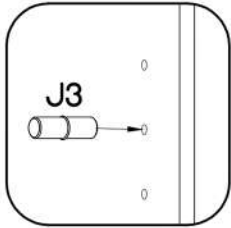

8

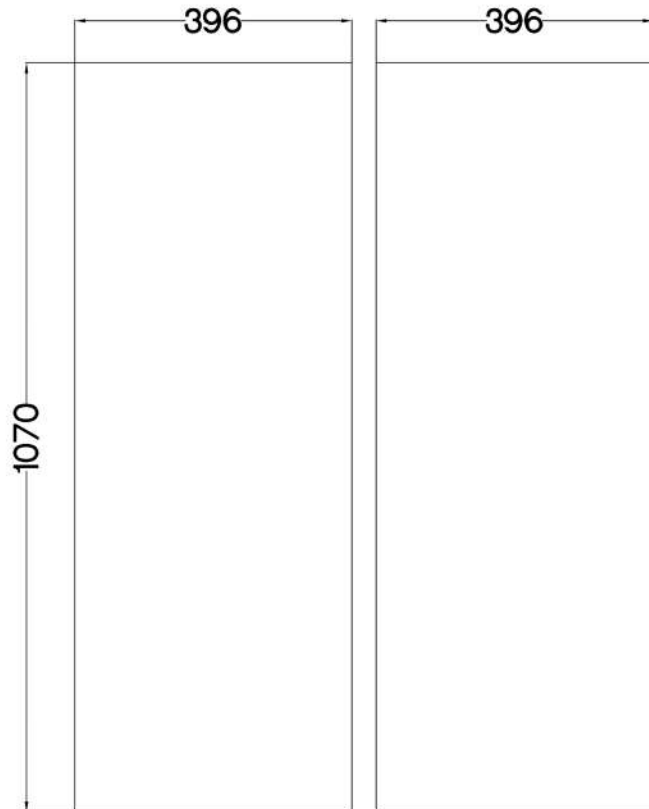

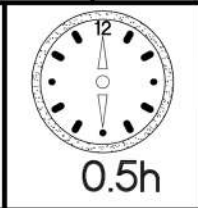
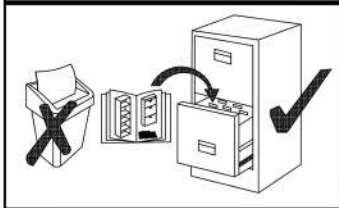
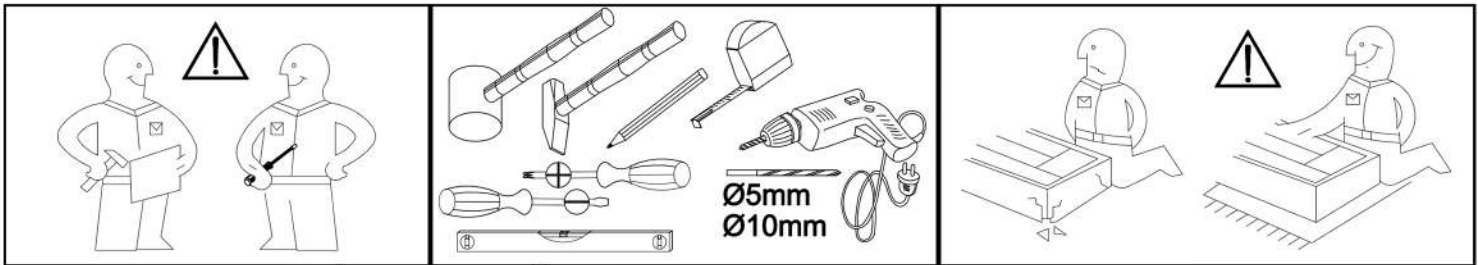

**1070x396**

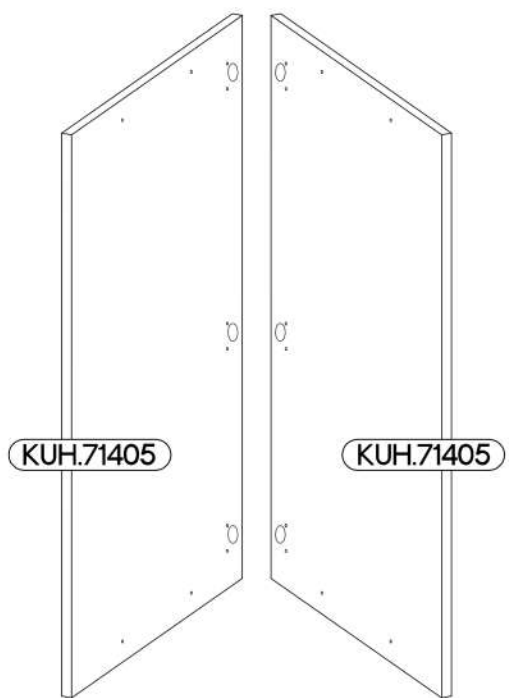
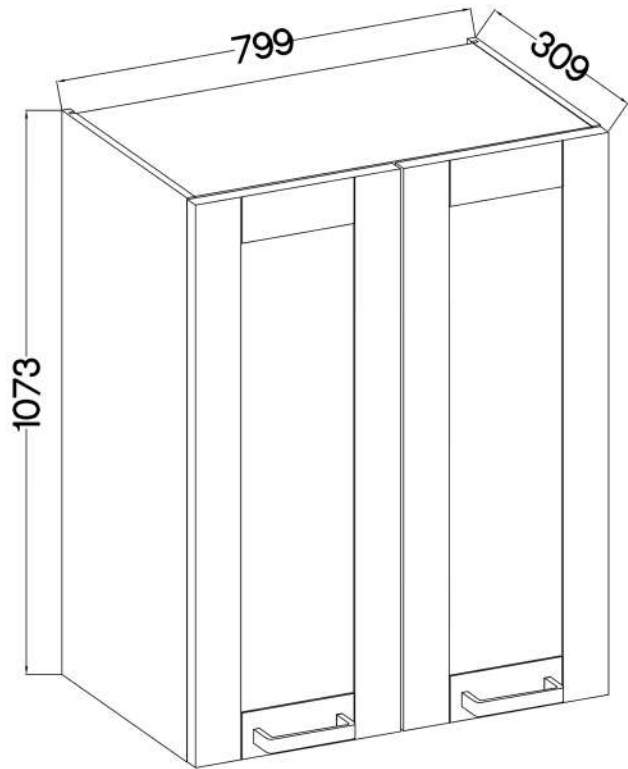



|         |         |
|---------|---------|
| L=160mm | M4x27mm |
|         |         |
| S       | U8      |
| 2       | 4       |

KUH.71405 x2 1070x396x19

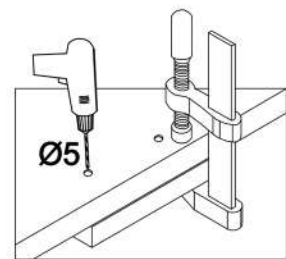
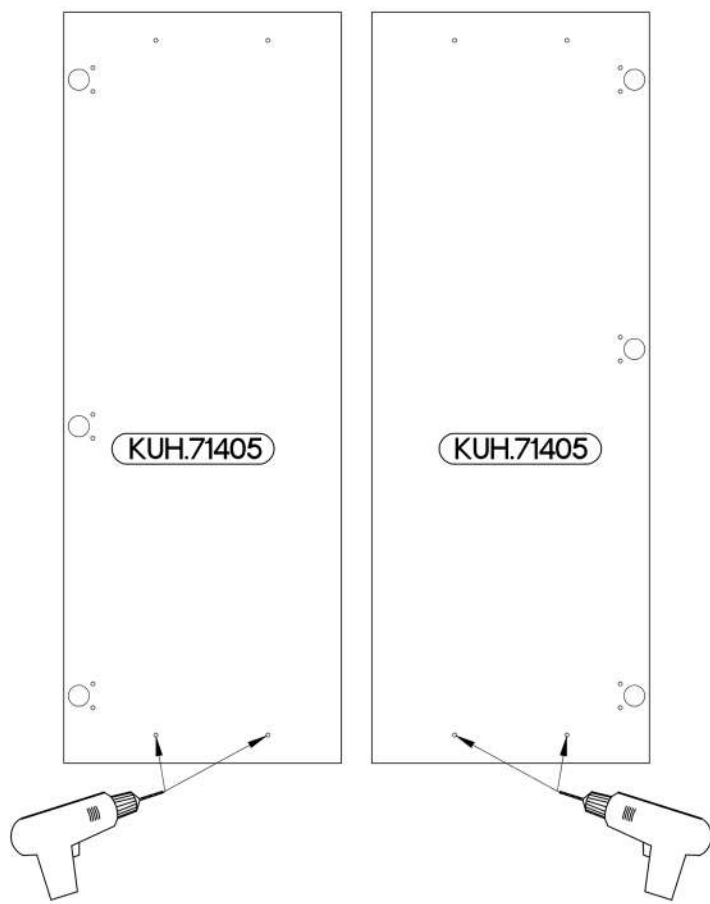
1



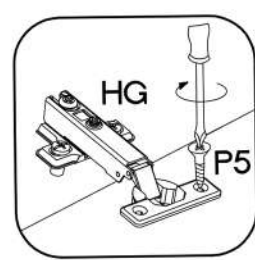
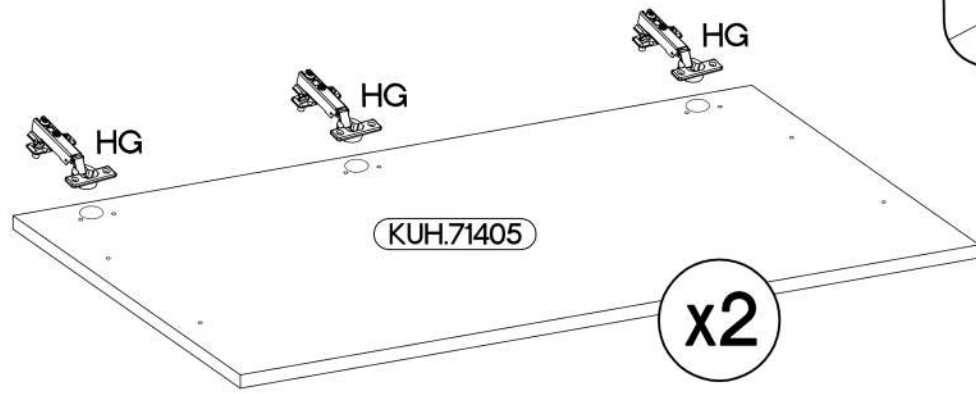

2

|  |   |
|--|---|
| <br>HG<br>6 | <br>P5<br>12 |
|--|---|



3

|   |   |
|---|---|
| L=160mm   | M4x27mm   |
|  |  |
| S   | U8  |
| 1   | 2   |

