

FRISBO 30 D CARGO BB

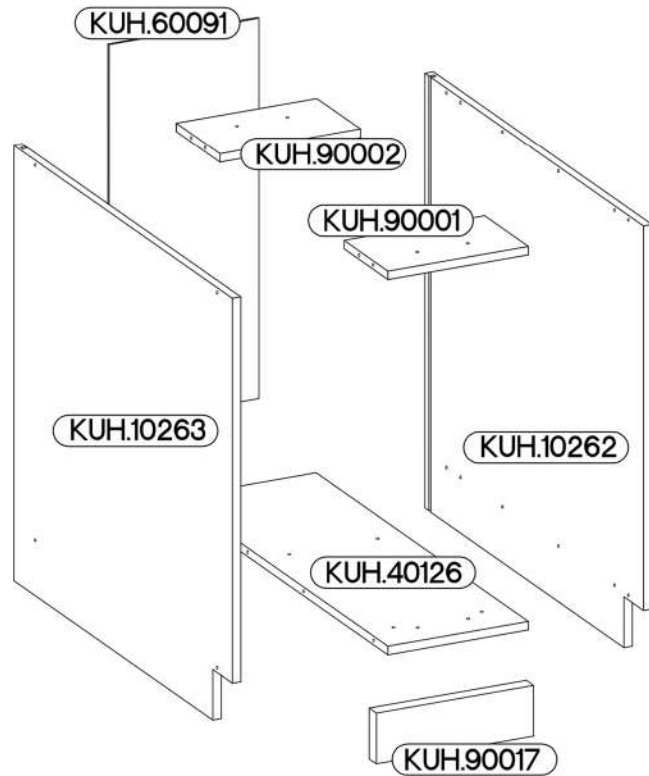

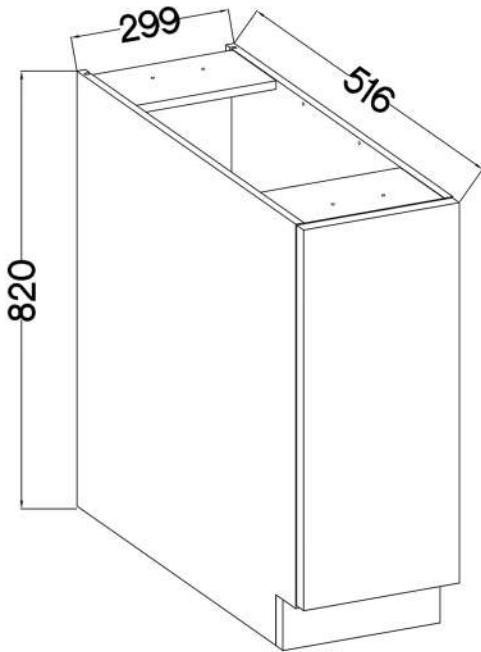
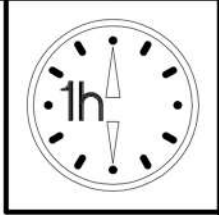
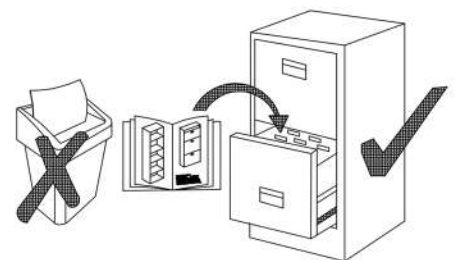

KUH.10262	815x500x16
KUH.10263	815x500x16
KUH.40126	267x485x16
KUH.90001	267x100x16
KUH.90002	267x100x16
KUH.60091	713x285x2,5
KUH.90017	299x95x16

A	B					
8	8					
E1	E9	F2	O	P4	P7	R3
8	2	4	1	2	8-10	4



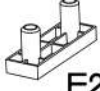

1

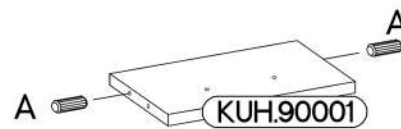
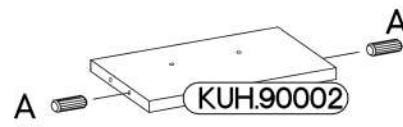
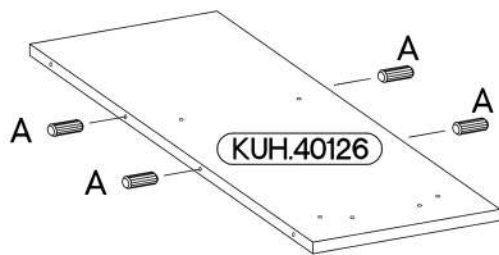
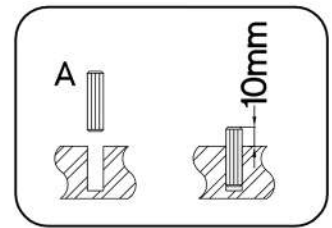
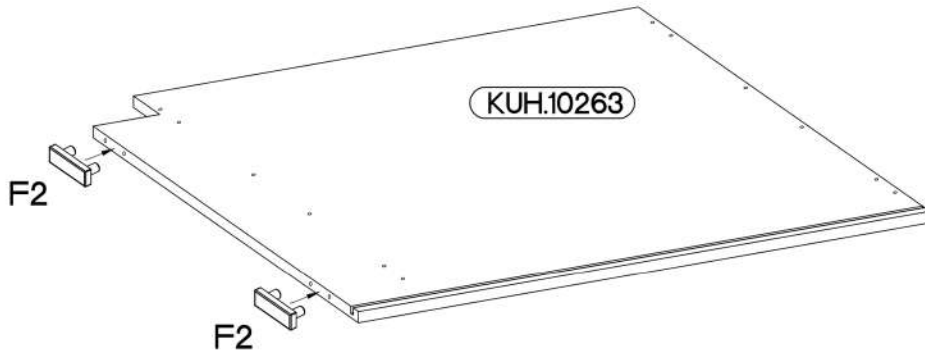
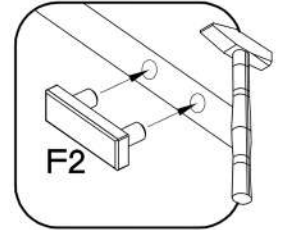
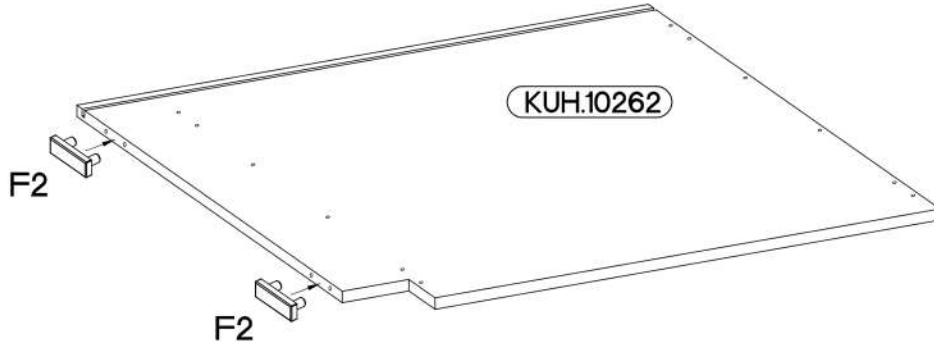
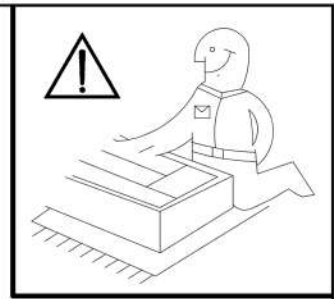
6.5x48x16	±8x30mm
	
F2	A
4	8





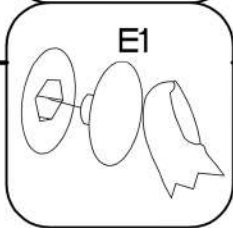
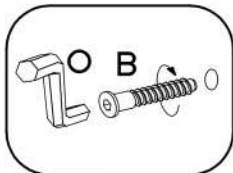
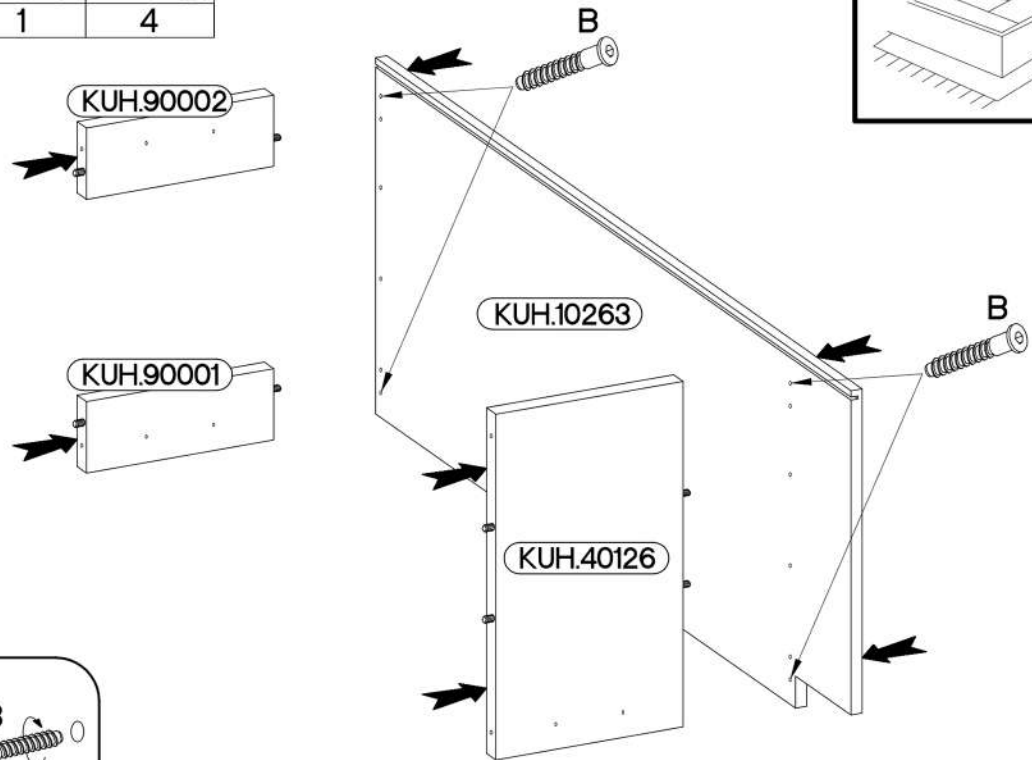
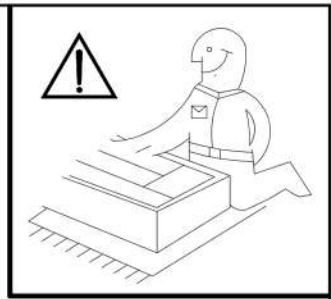

2

6,4 x 50mm		
		
B	O	E1
4	1	4

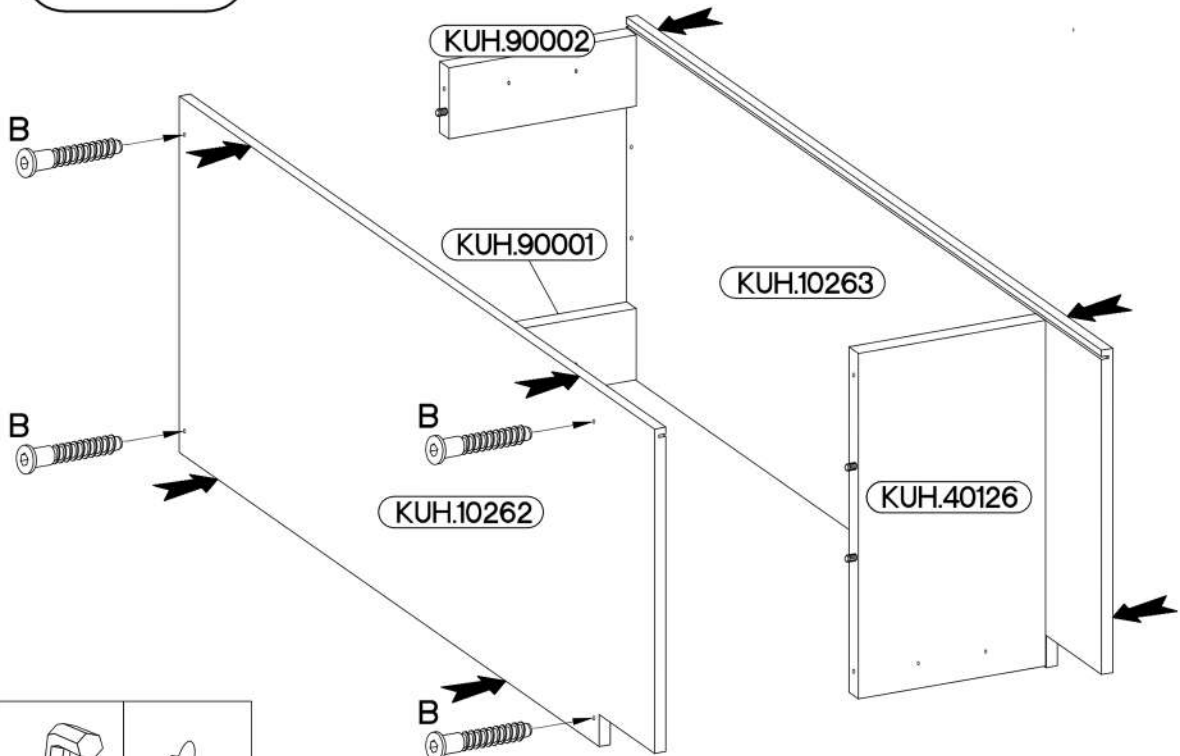

3



6,4 x 50mm		
		
B	O	E1
4	1	4

4

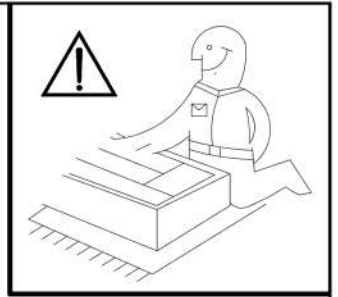
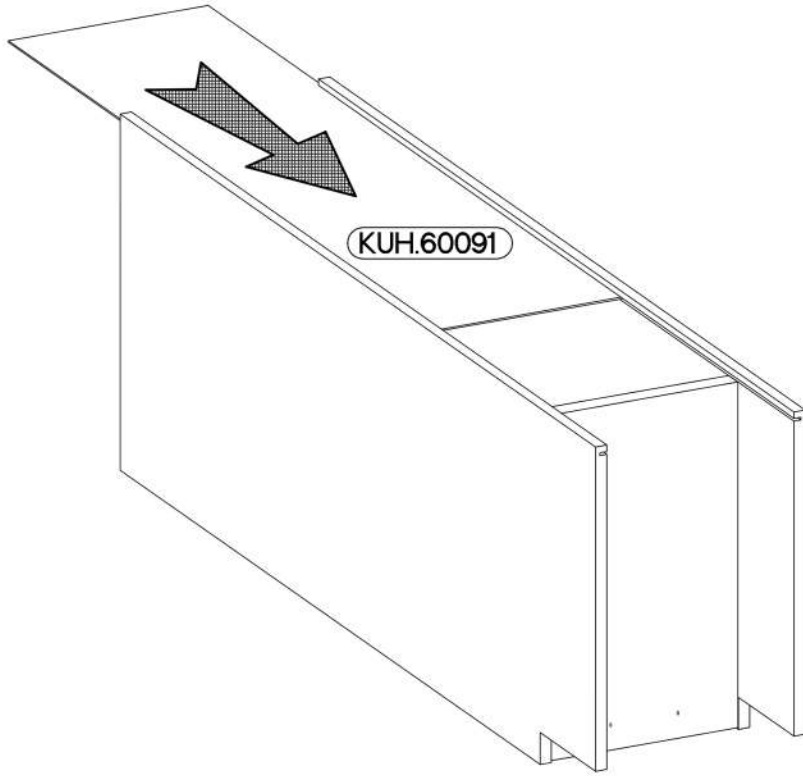

5

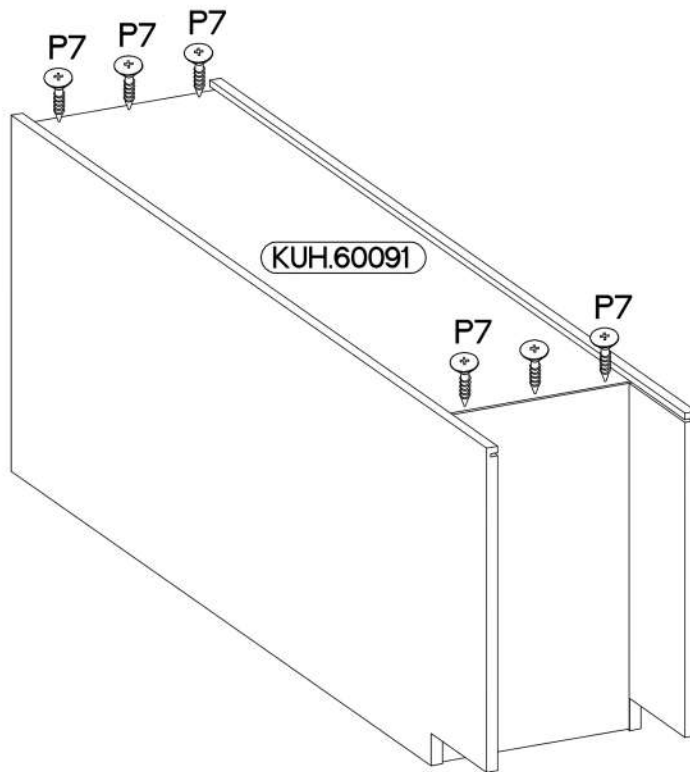
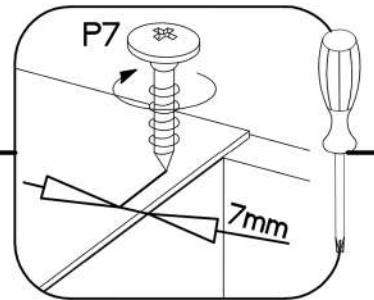
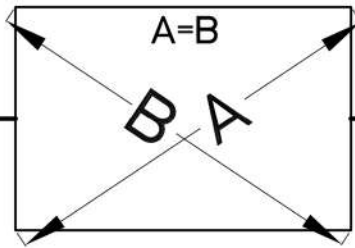

6

+4.0x45mm P4 2	E9 2	+4.0x35mm R3 4
----------------------	---------	----------------------

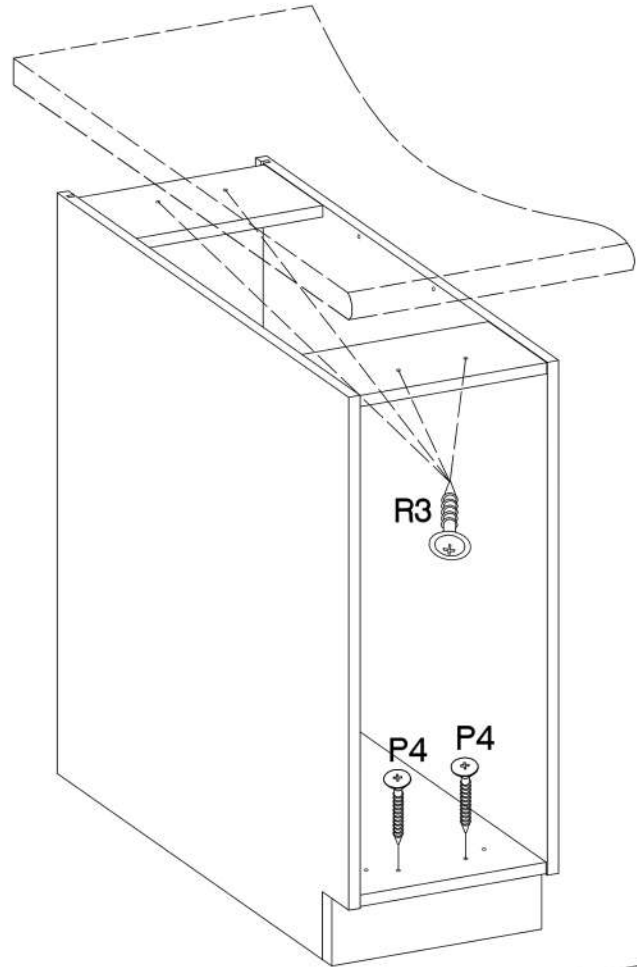
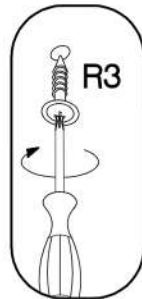
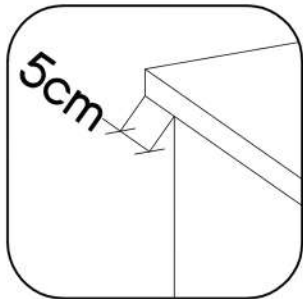
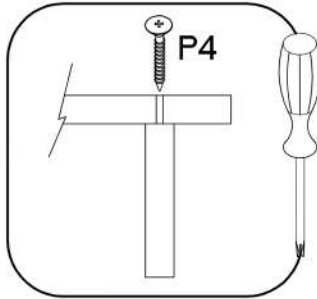

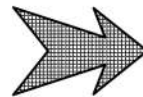
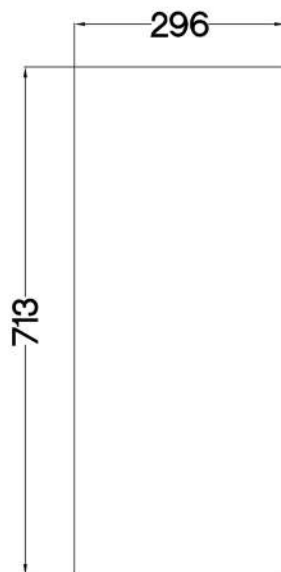

7

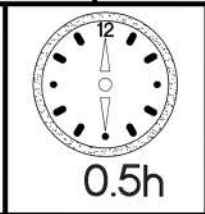
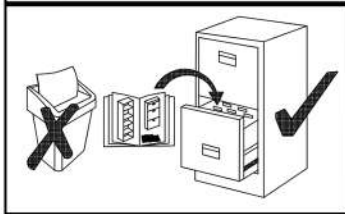
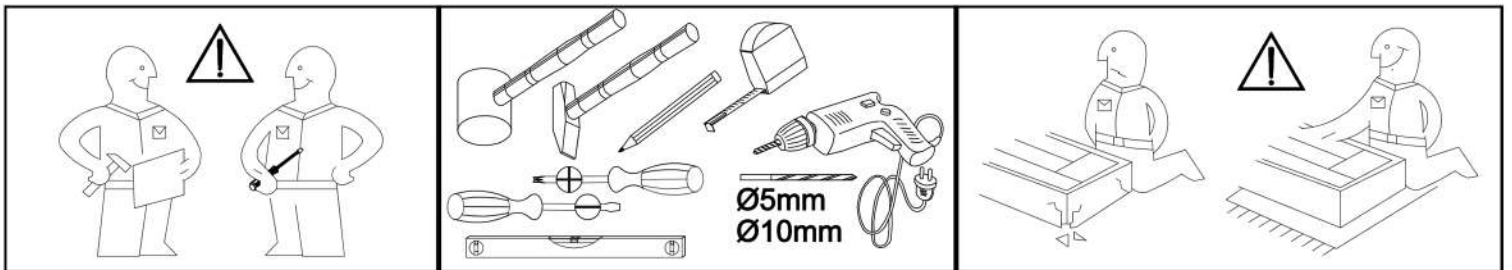

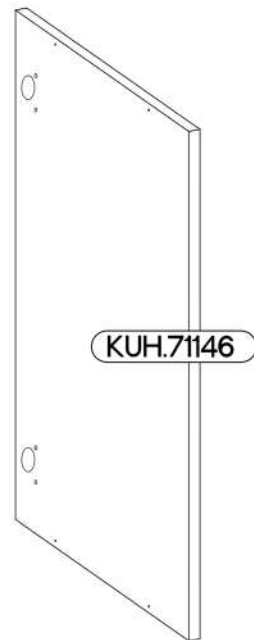
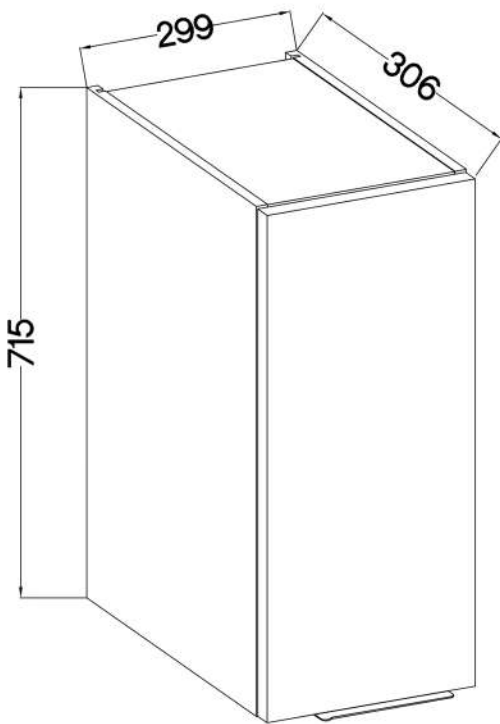
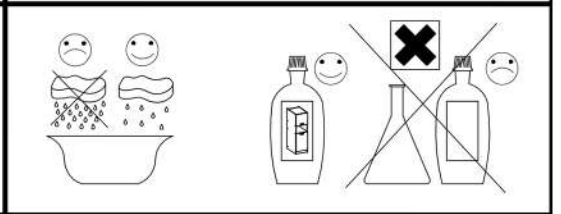

713x296



L=160mm	+7/2mm
	
S	J5
1	2

KUH.71146	713x296x16
-----------	------------

1

$\pm 35/0\text{mm}$ [CD] HG 2	$\pm 3.5 \times 13\text{mm}$ P5 4	$\pm 7/2\text{mm}$ J5 2
-------------------------------------	---	-------------------------------

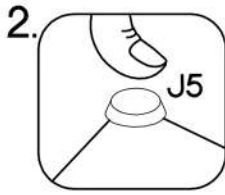
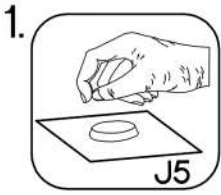
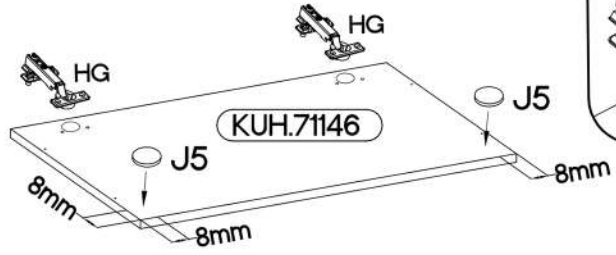
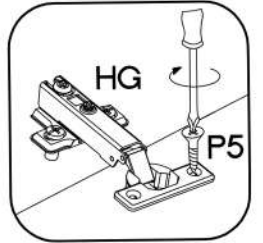

2

L=160mm S 1

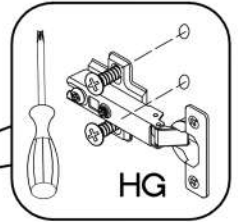

KUH.71146

