

# FRISBO 60D GAZ BB

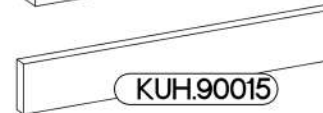

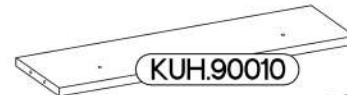

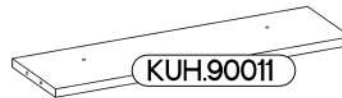
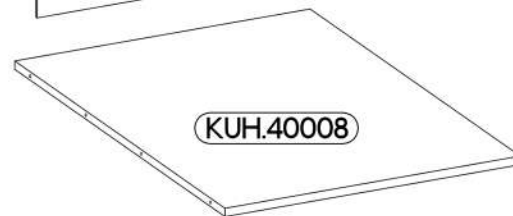
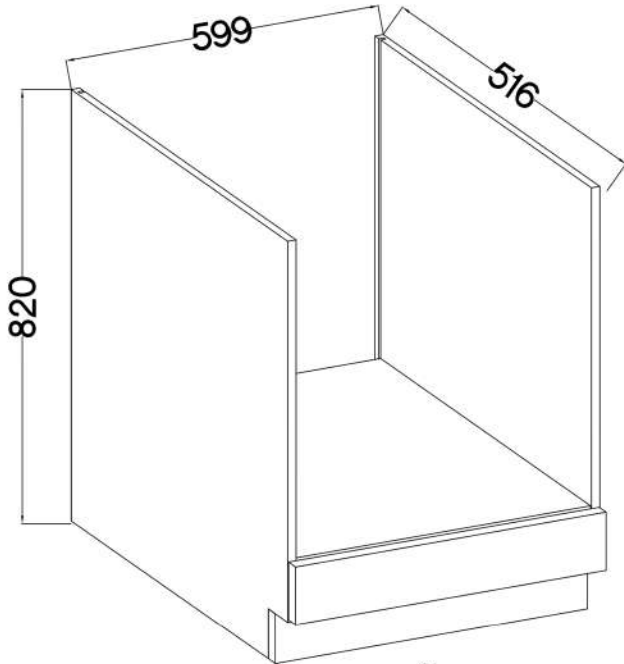

KUH.10045	815x500x16
KUH.10046	815x500x16
KUH.40008	567x485x16
KUH.60007	115x585x2,5
KUH.90010	567x100x165
KUH.90011	567x100x165
KUH.90015	599x95x16

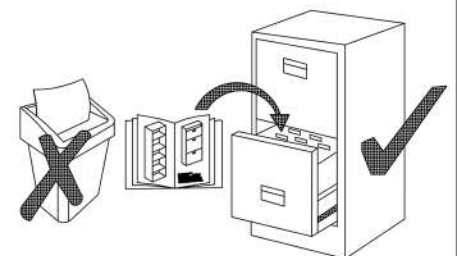
+8x30mm	6,4 x 50mm
A	B
8	8

	6.5x48x16 			+4.0x45mm 	+3.5x13mm 	+3.0x20mm 
E1	F2	L28	O	P4	P5	P7
8	4	2	1	2	8	8-10

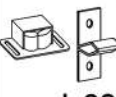

1

 #8x30mm A 8	 6.5x48x16 F2 4	 L28 2	 #3.5x13mm P5 8
--	---	---	---

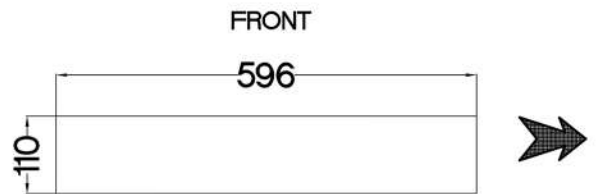
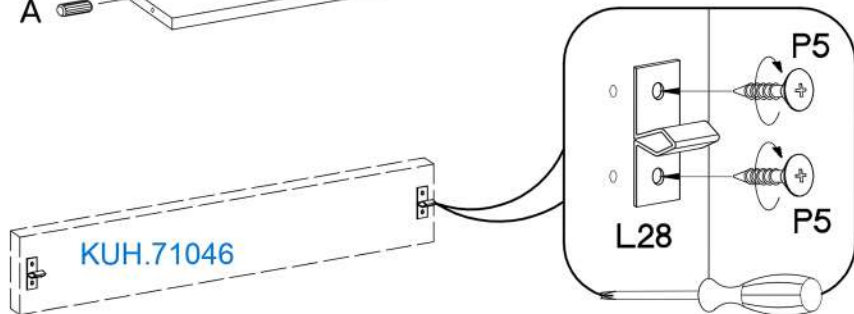
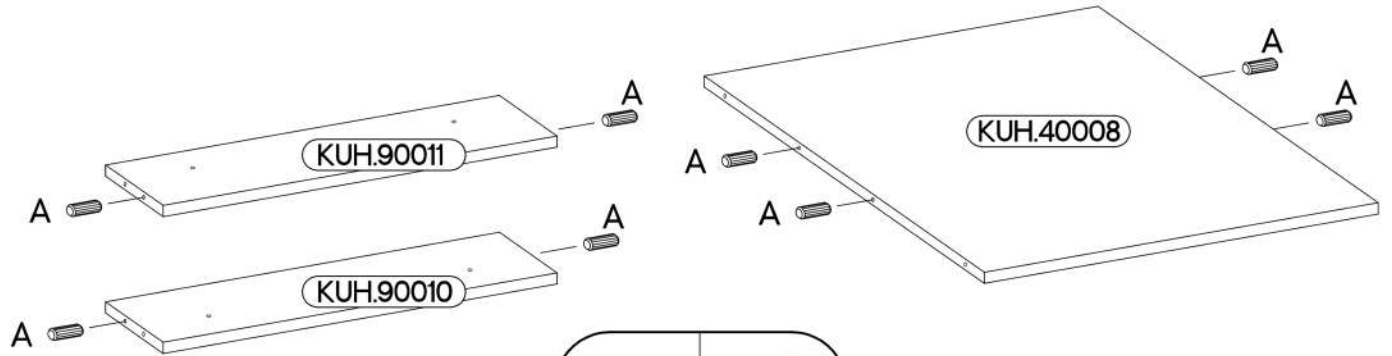
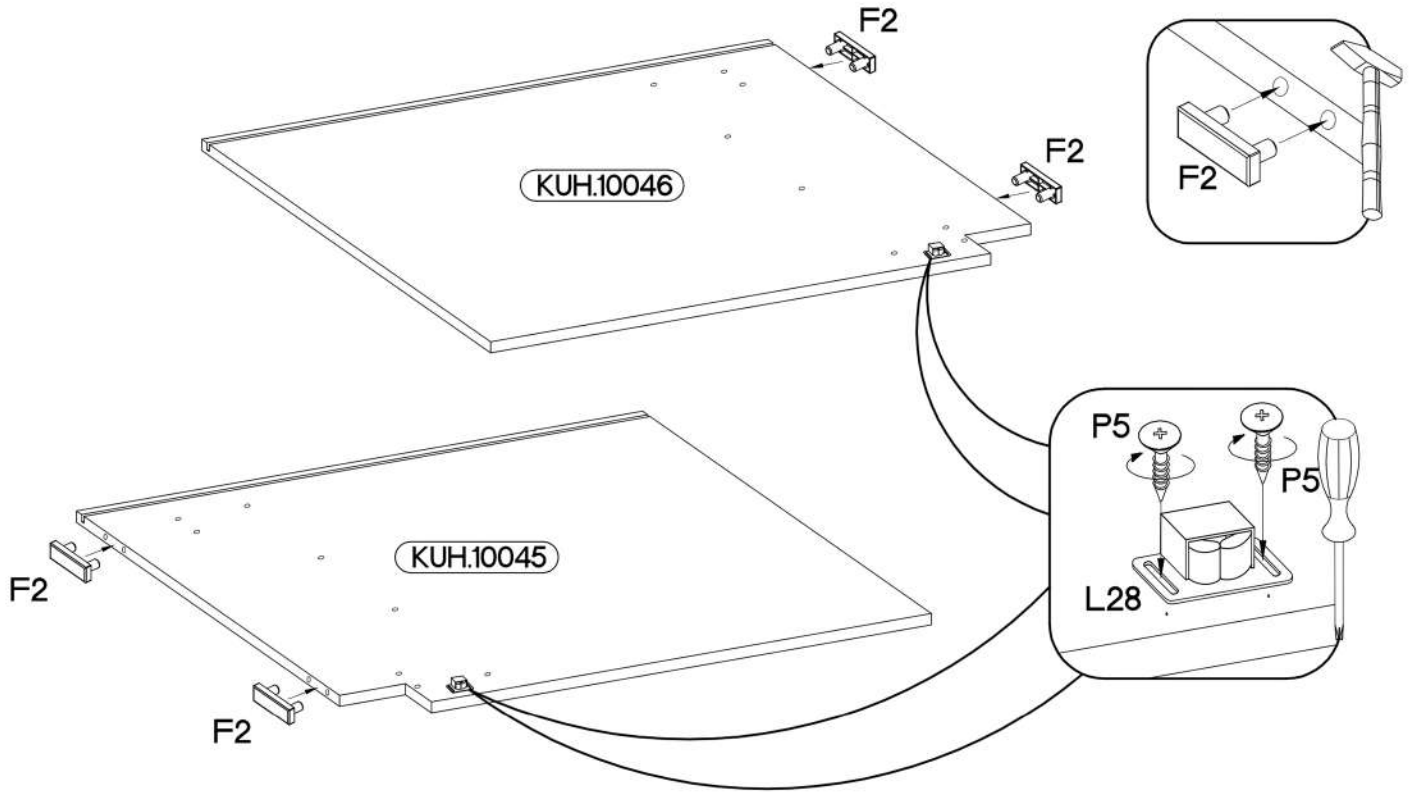
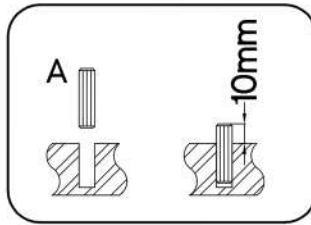

# 2

6,4 x 50mm

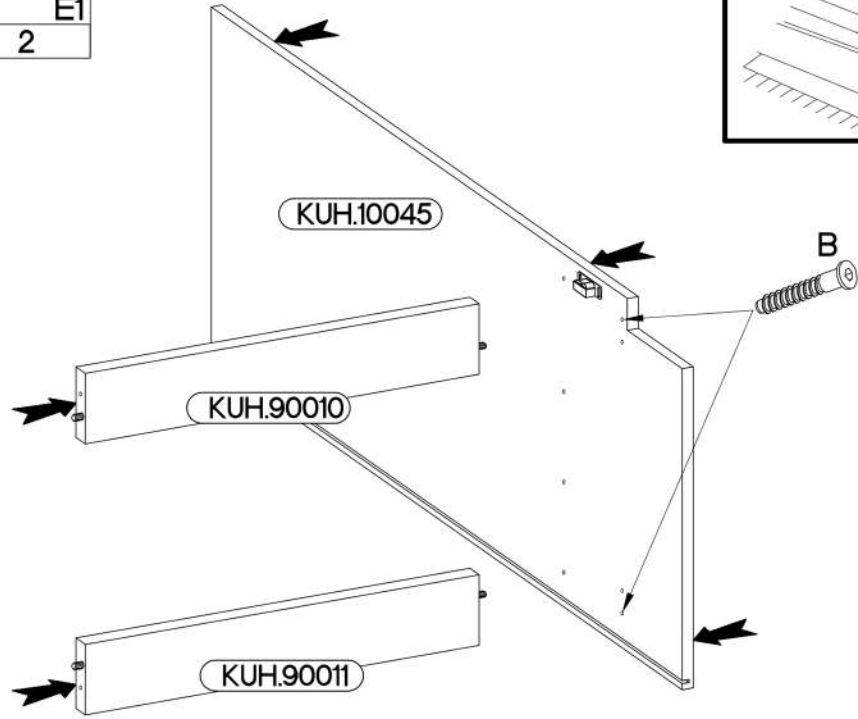
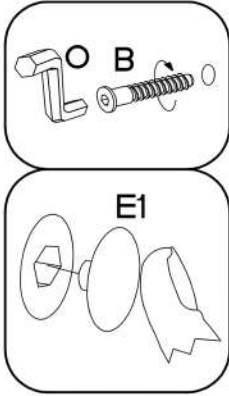
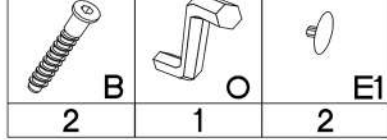

# 3

6,4 x 50mm

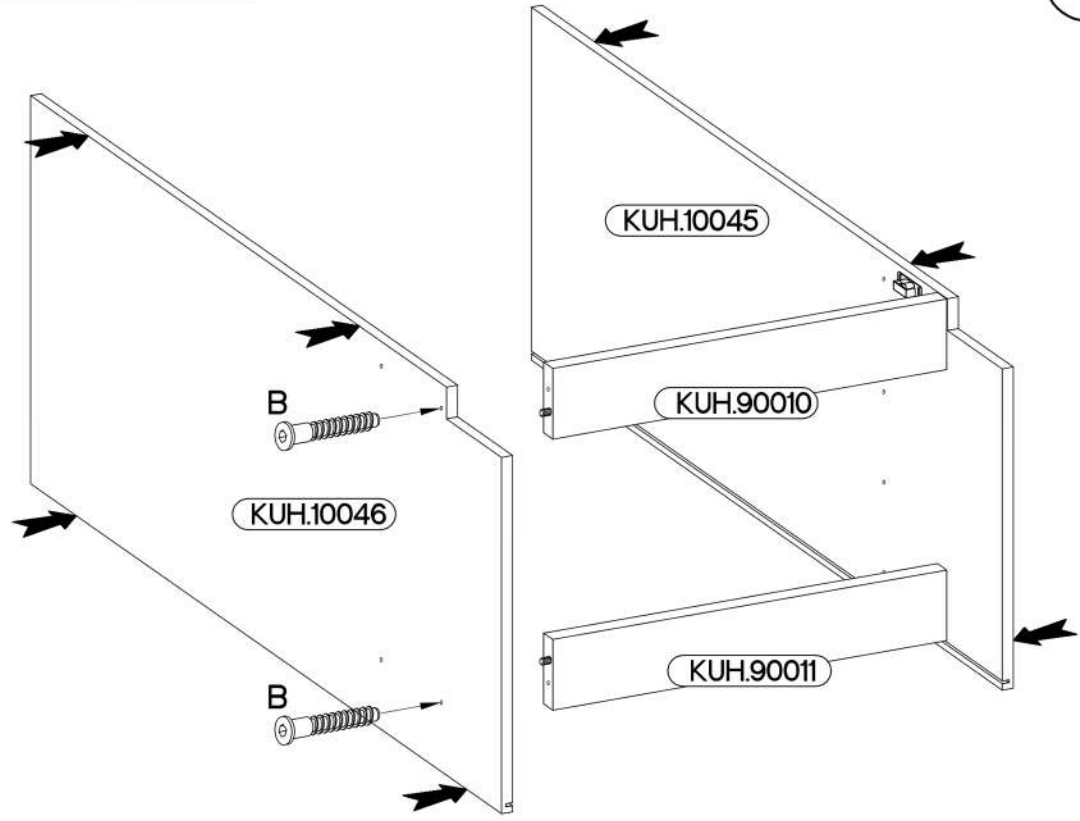
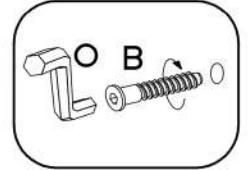
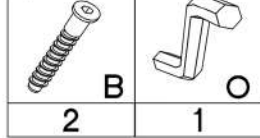

4

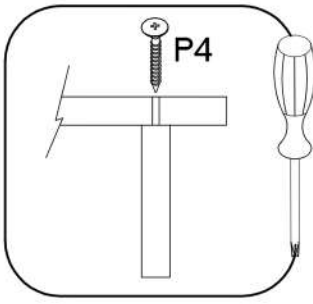
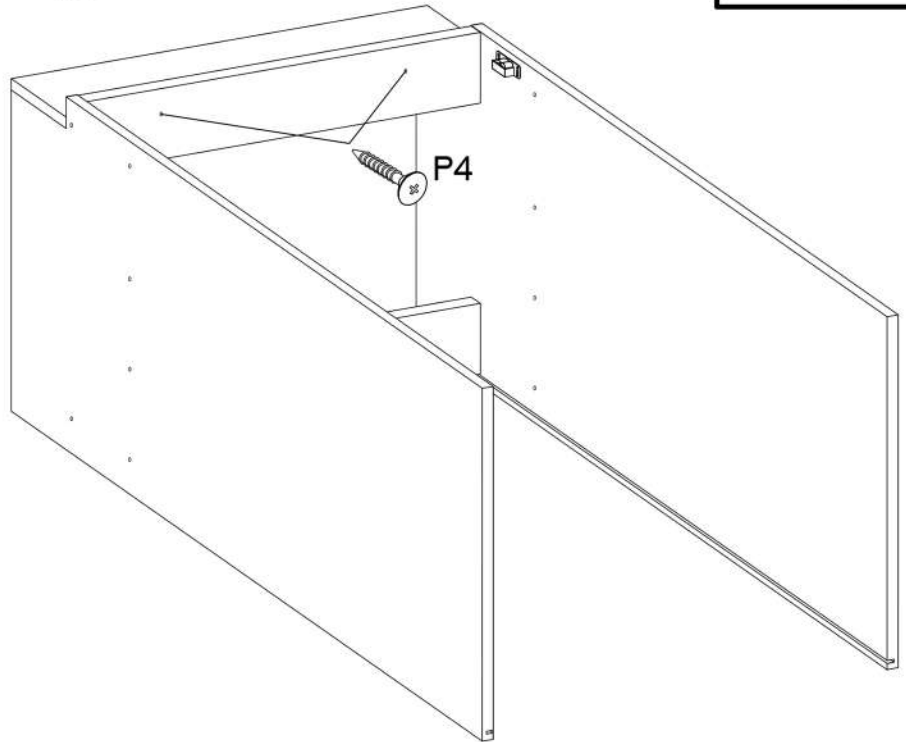
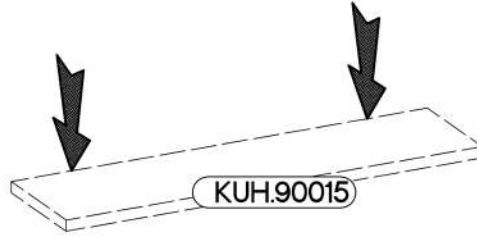
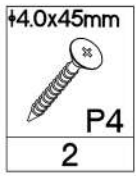

5

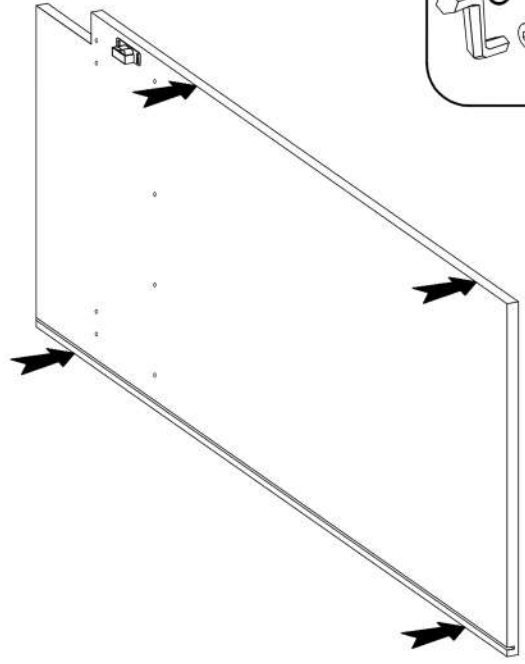
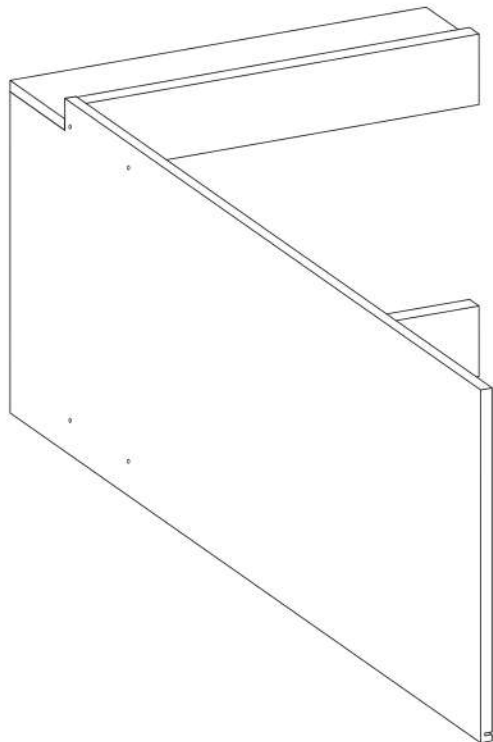
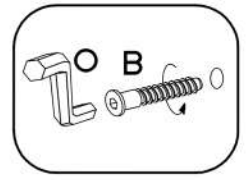

6

6,4 x 50mm



B

6



O

1



E1

6

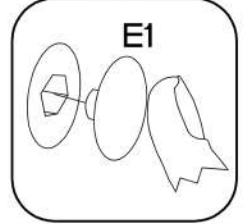
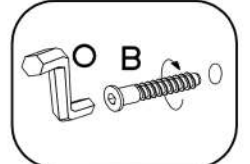
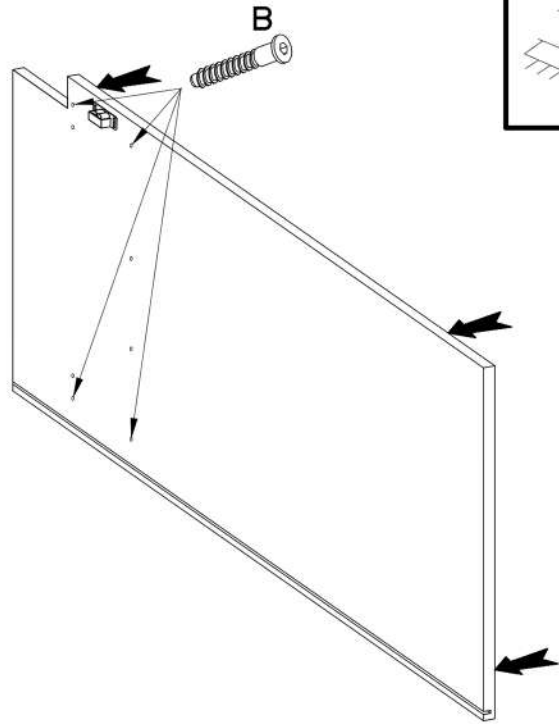
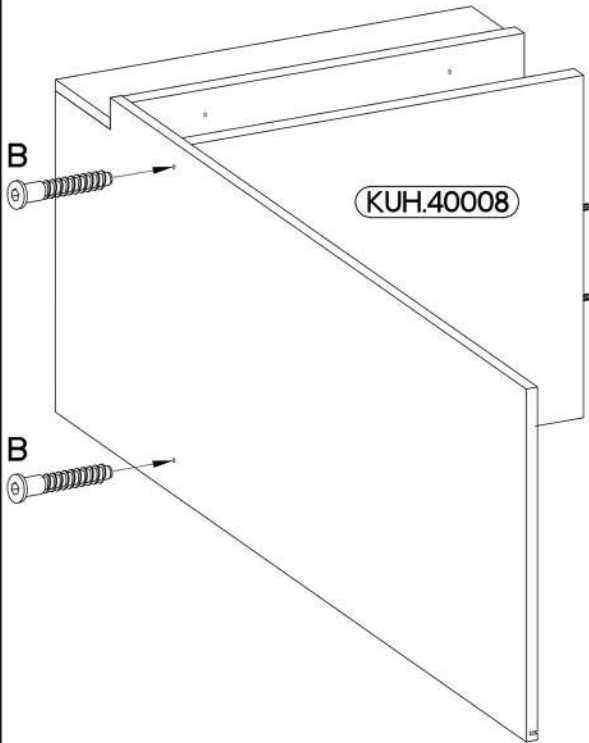
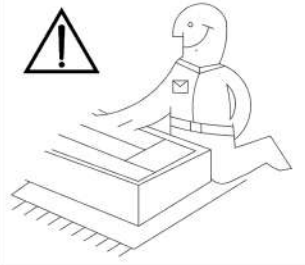

7

±3.0x20mm



P7

8-10

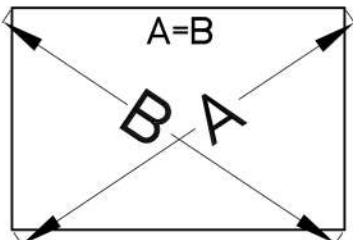
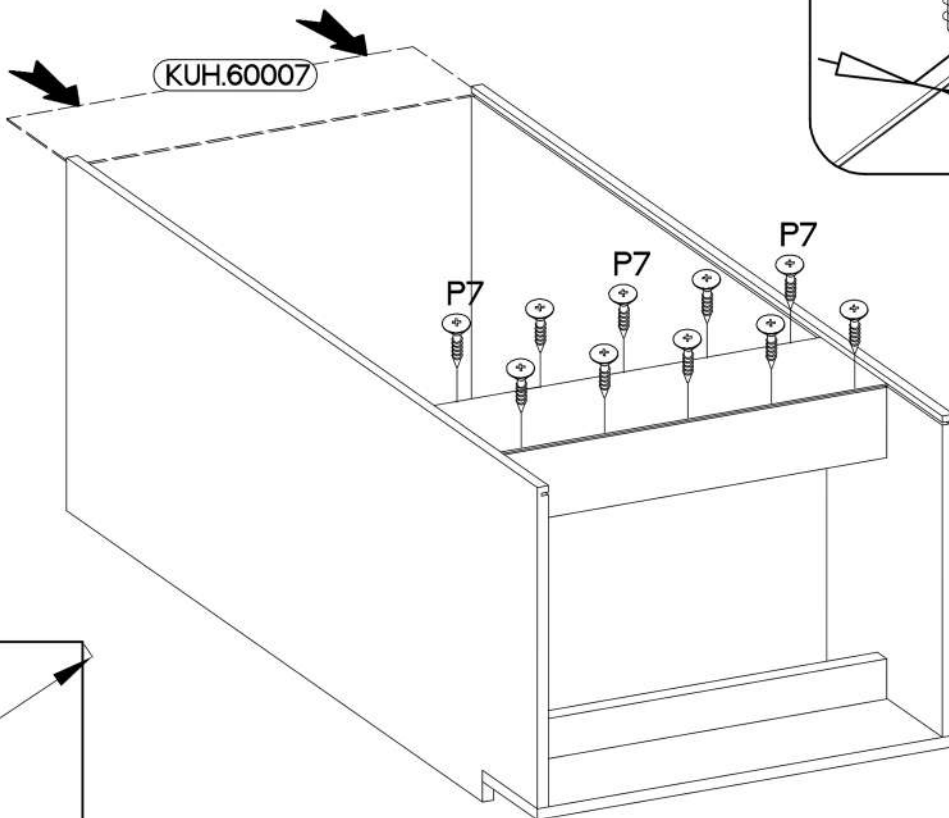
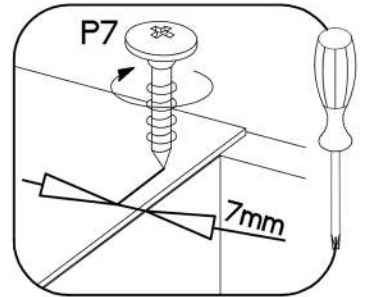

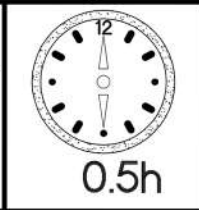
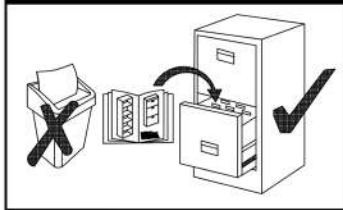
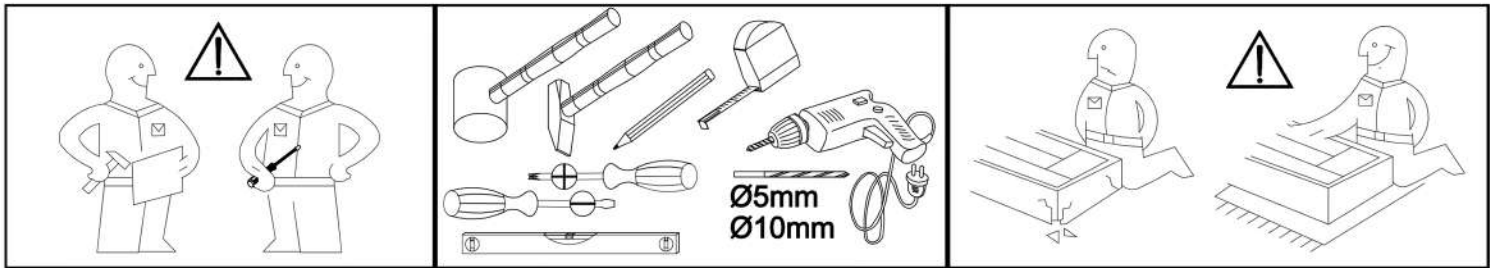

**60 D GAZ BB**

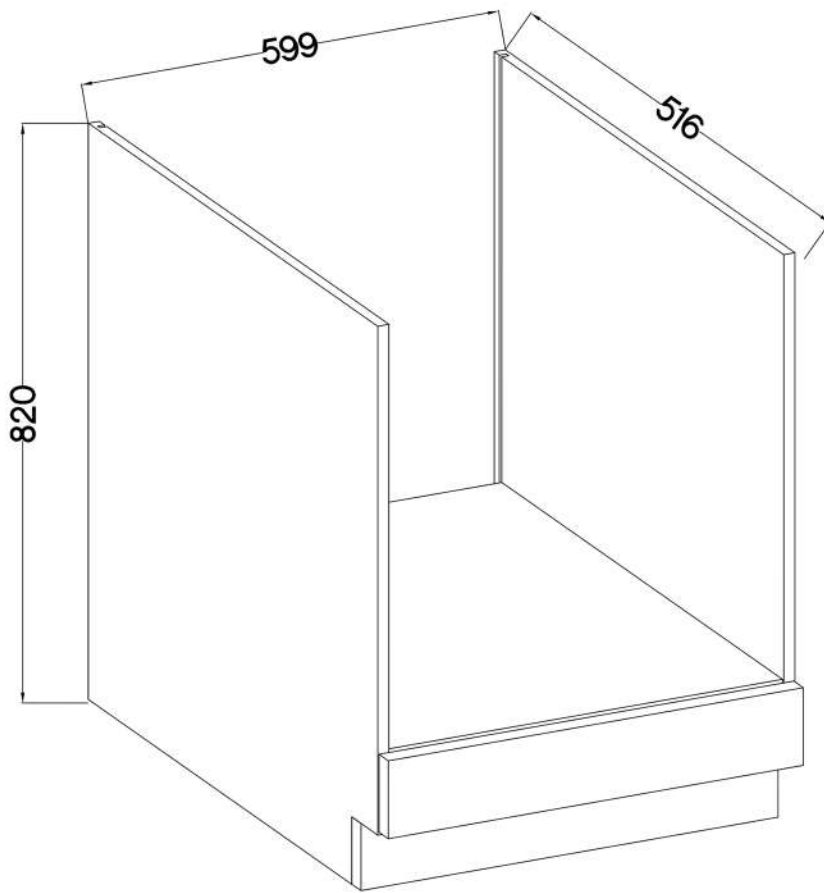
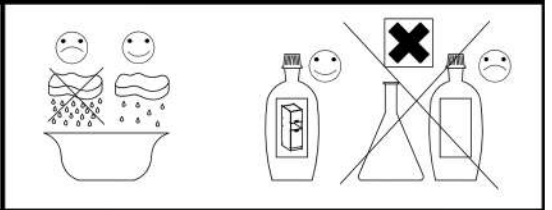

KUH.71046	110x596x16
-----------	------------

1

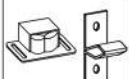
	$\pm 3.5 \times 13 \text{mm}$
L28	P5
2	4

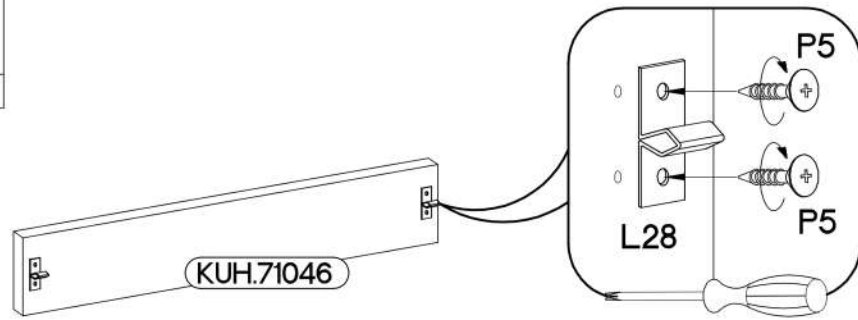

2

