

ARSANY/FRISBO 15 G-108 OTW

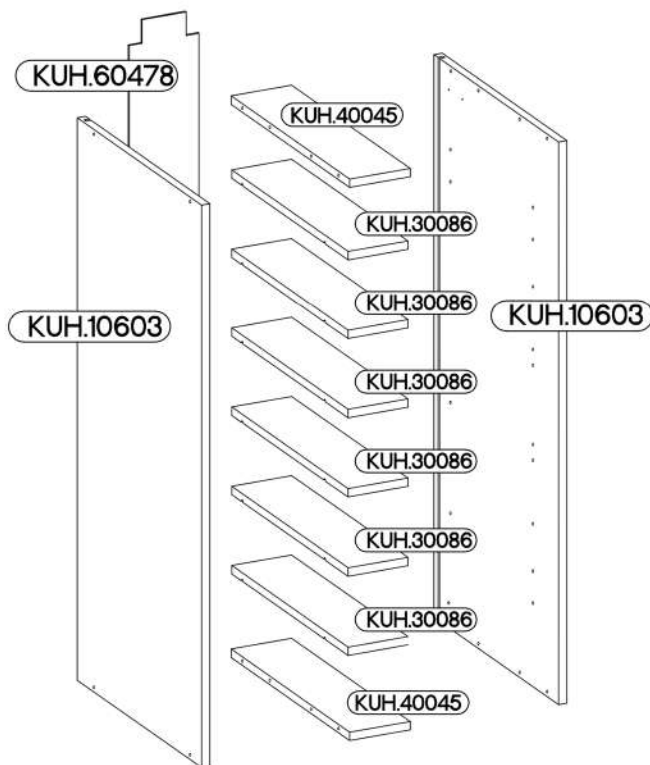

max. 5kg
 KUH.30086
 KUH.40045

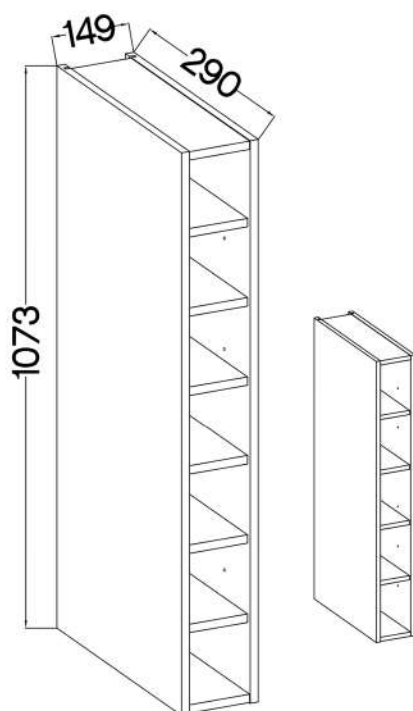

KUH.10603 x2	1073x290x16
KUH.30086 x6	117x271x16
KUH.40045 x2	117x276x16
KUH.60478	1070x135x2,5

 +8x30mm A 8	 6,4 x 50mm B 8	 E1 8	 +5/16mm J3 24
 K 2	 O 1	 +3.0x20mm P7 4	 +4.0x30mm P8 4

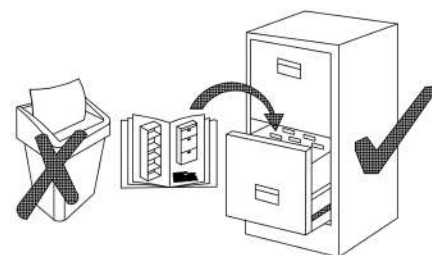

1

$\pm 8 \times 30 \text{mm}$	$\pm 4.0 \times 30 \text{mm}$	
A	P8	K
8	4	2

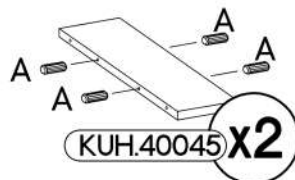
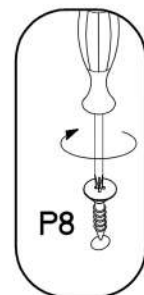
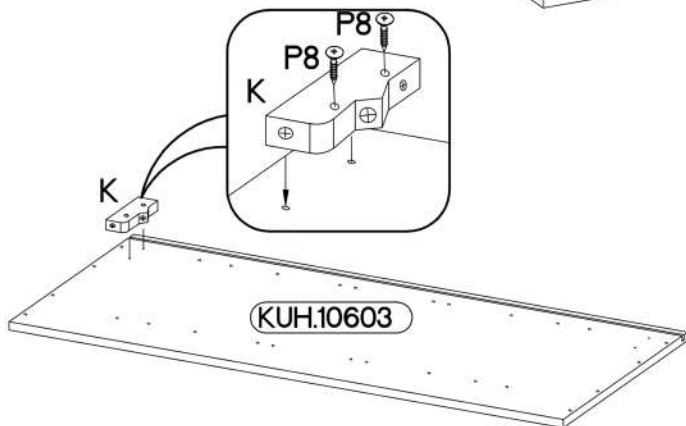
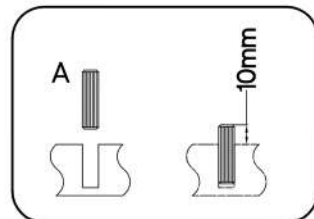
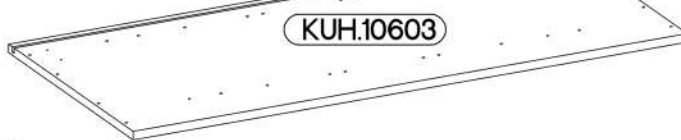
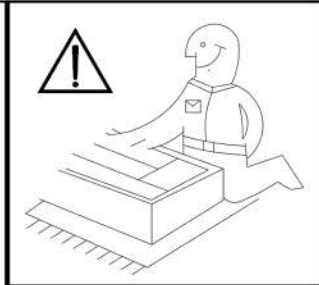
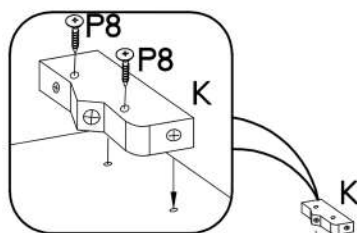

2

$6,4 \times 50 \text{mm}$		
B	O	E1
8	1	8

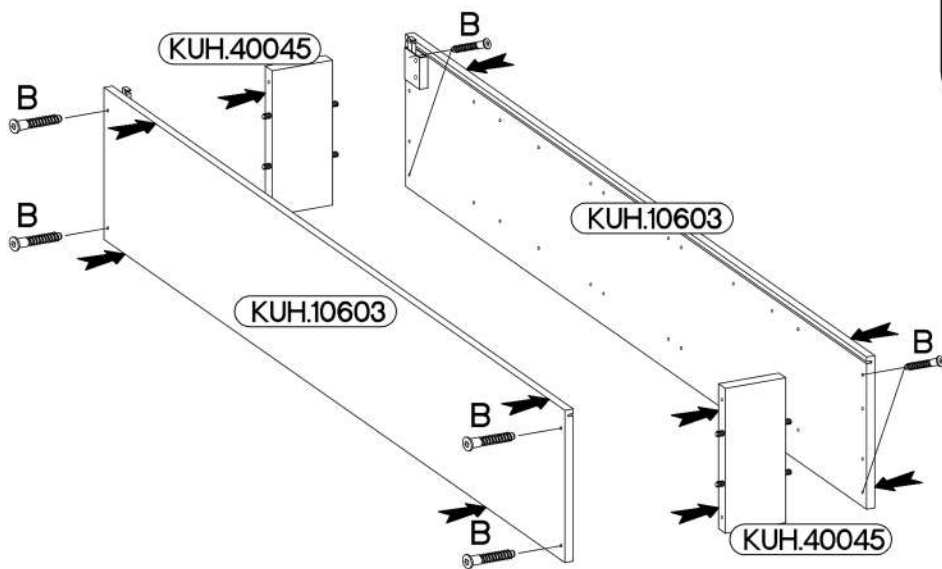
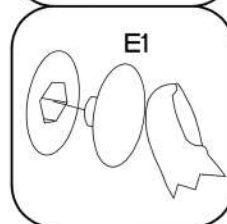
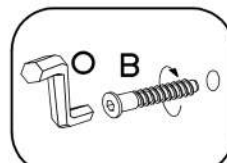

3

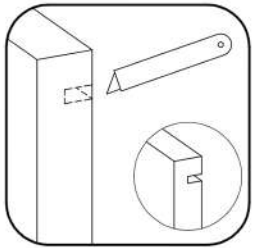
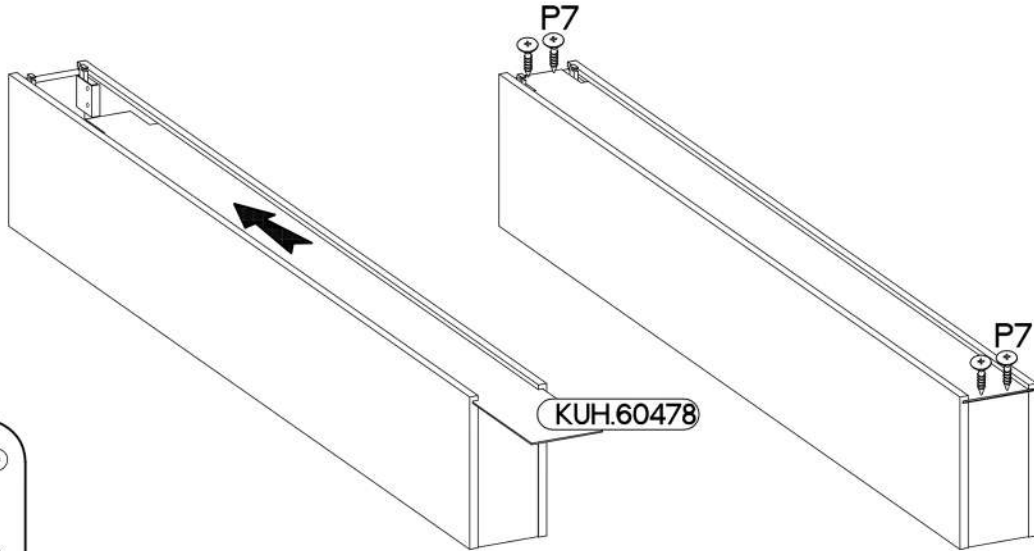
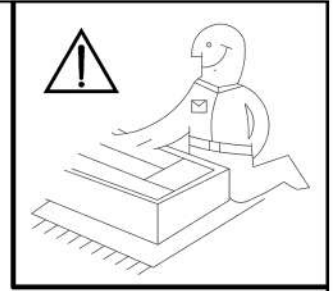
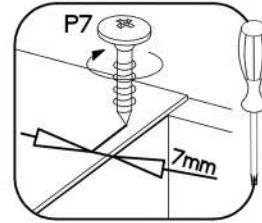
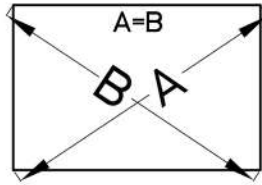

4

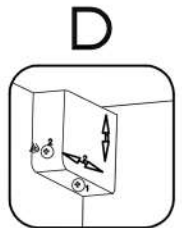
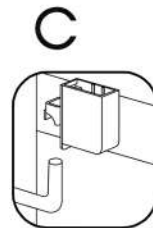
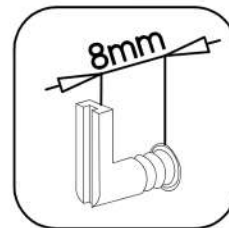
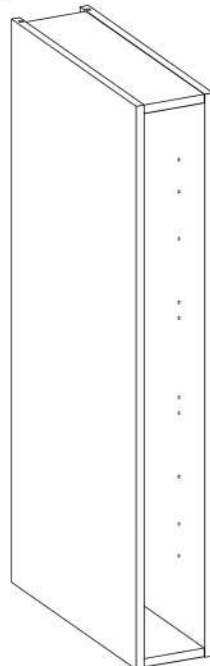
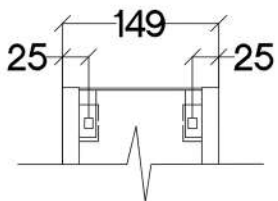
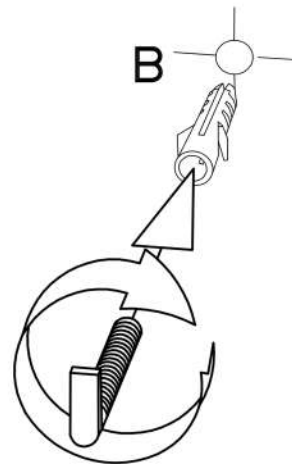
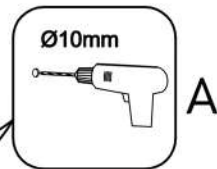
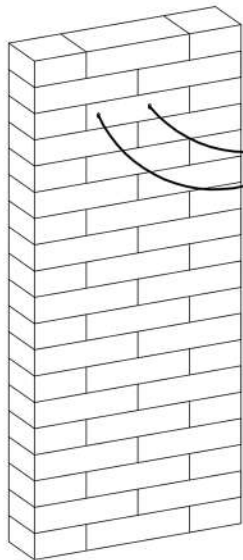

5

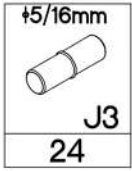

1.

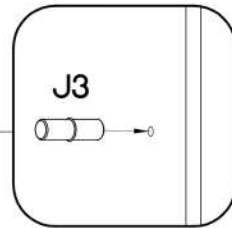
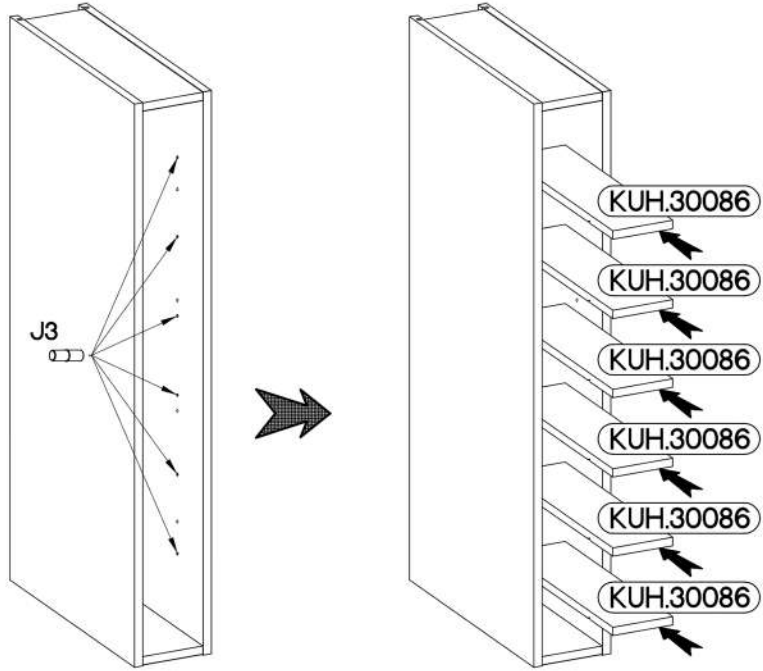

6

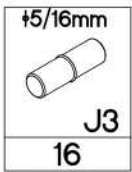

2.

