

ARSANY/FRISBO 15 G-72 OTW

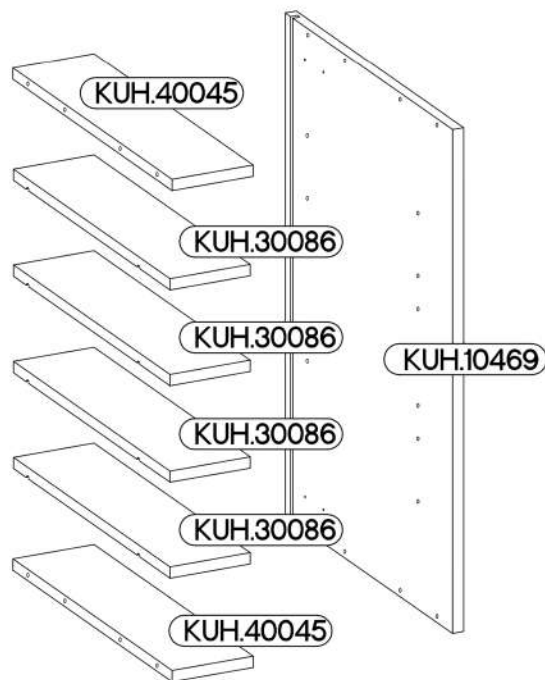

KUH.30086
KUH.40045

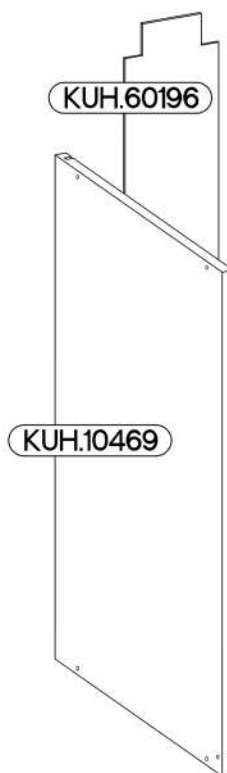

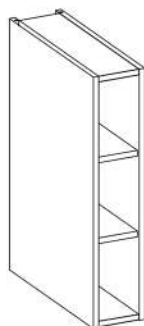
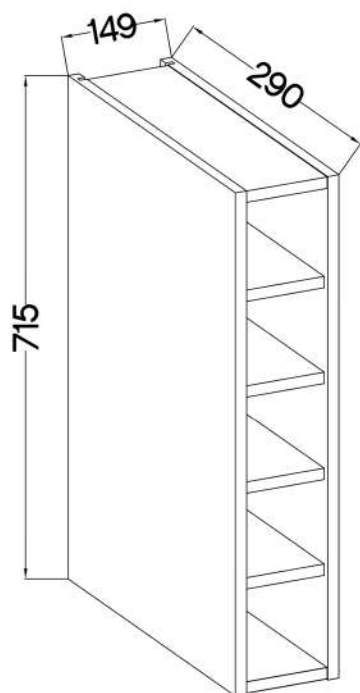

KUH.10469 x2	715x290x16
KUH.30086 x4	117x271x16
KUH.40045 x2	117x276x16
KUH.60196	713x135x2,5

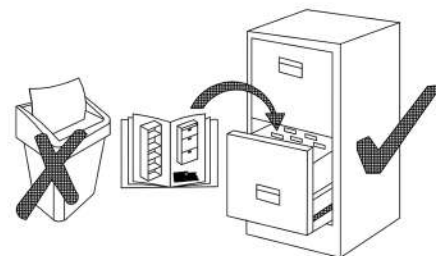
 A 8	 B 8	 E1 8	 J3 16
 K 2	 O 1	 P7 4	 P8 4



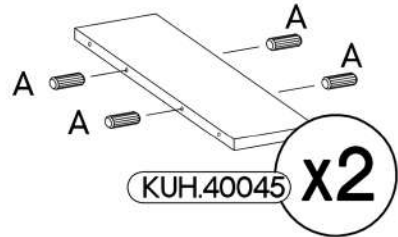
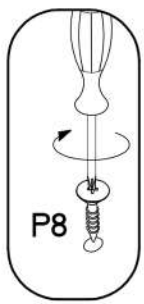
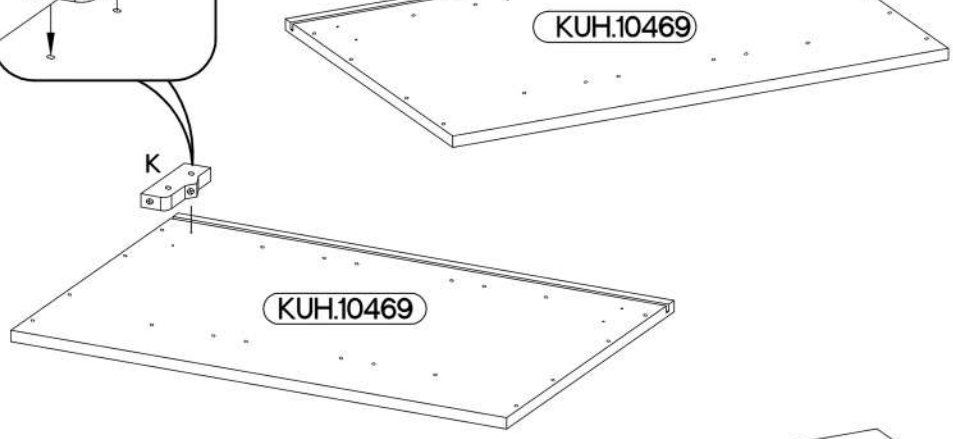
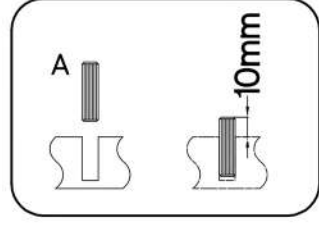
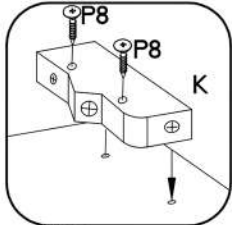
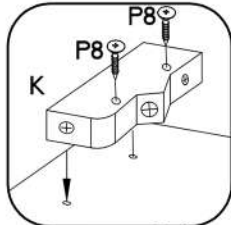
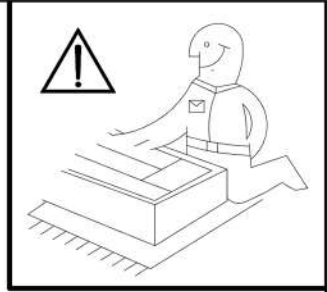

1

$\uparrow 8 \times 30 \text{mm}$  A	$\uparrow 4.0 \times 30 \text{mm}$  P8	 K
8	4	2



2

$6.4 \times 50 \text{mm}$  B	 O	 E1
4	1	4

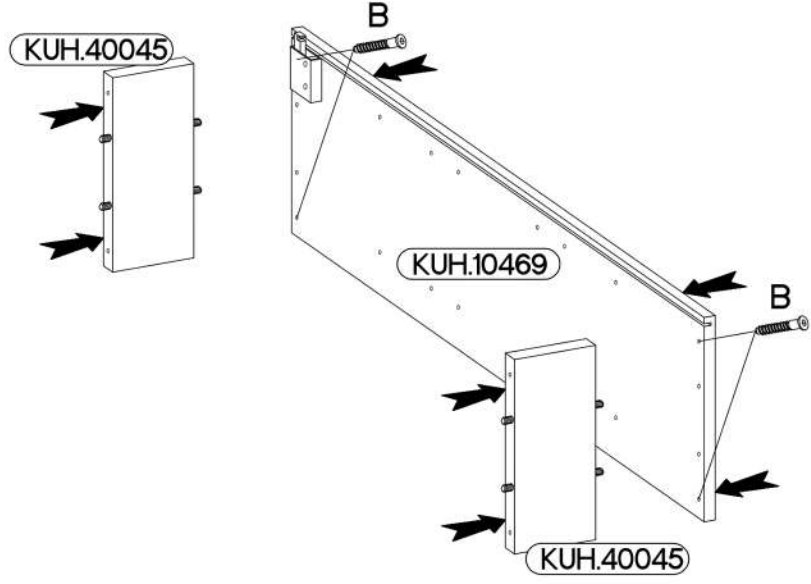
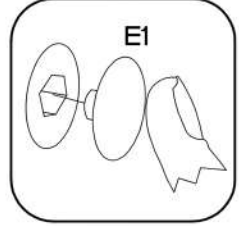
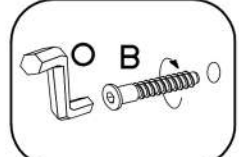

3

6,4 x 50mm

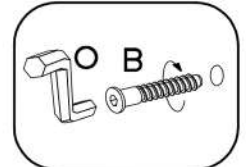
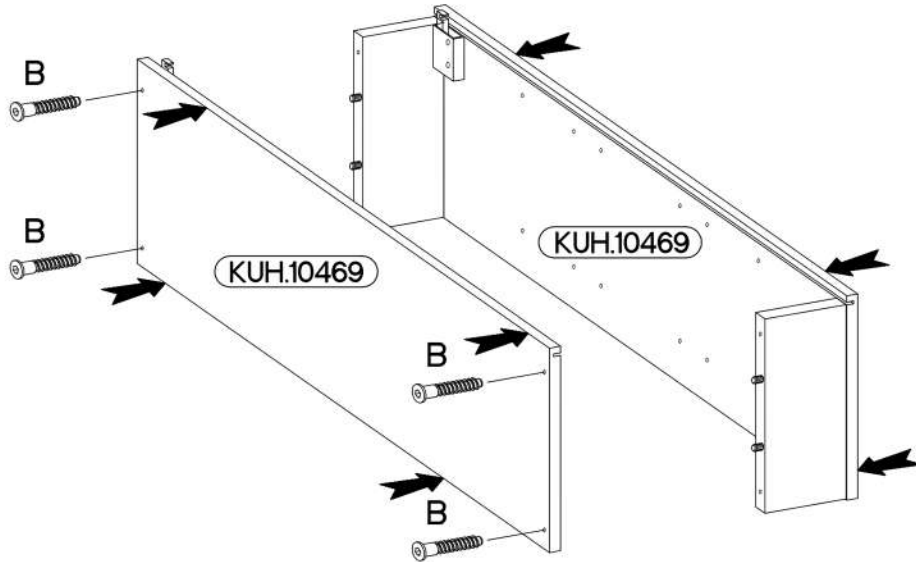
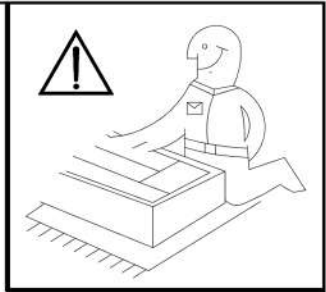
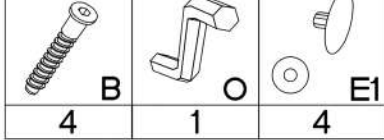

4

3.0x20mm

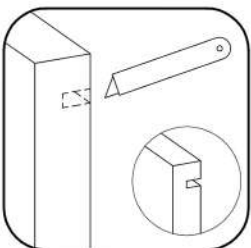
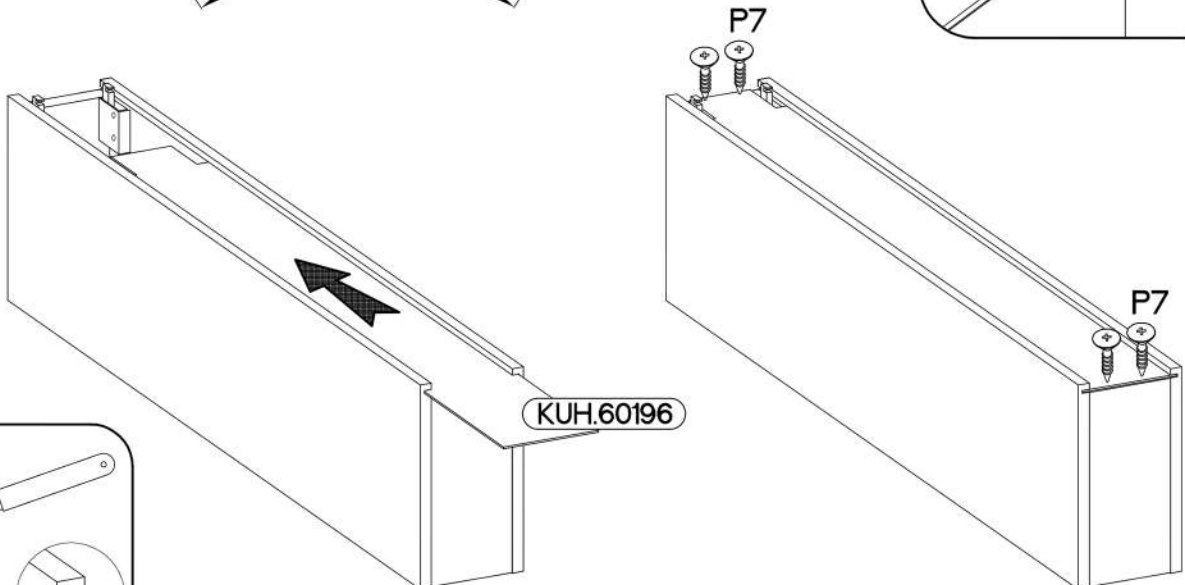
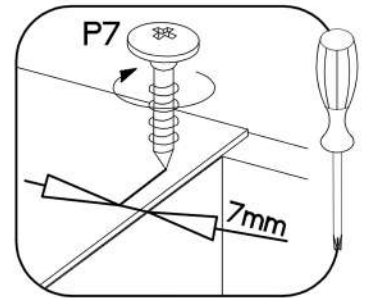
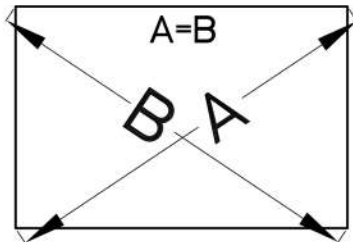
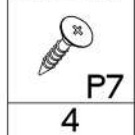

5

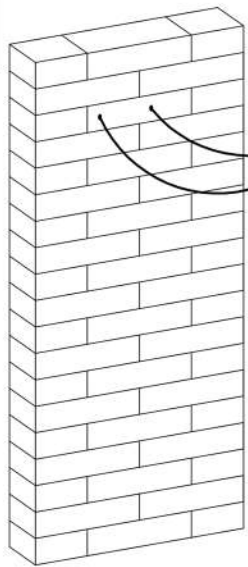

A



B



x2



C

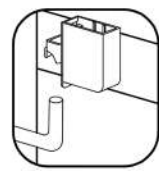

D

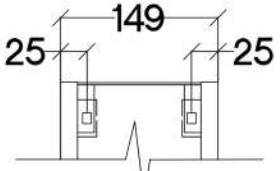

6

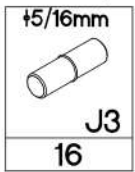

1.

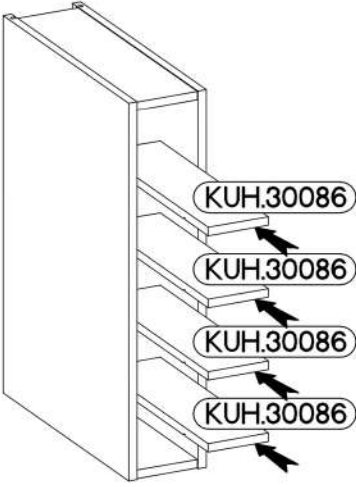
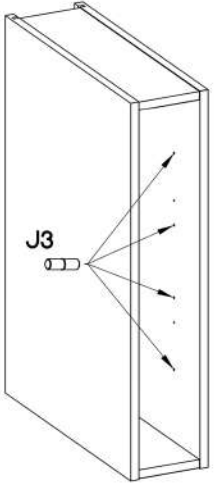
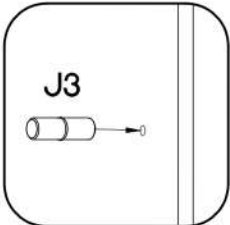

7

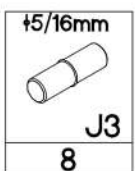

2.

