

ARSANY 60 DPM-210 2F

max. 10kg
 KUH.30002
 KUH.40007
 KUH.40008

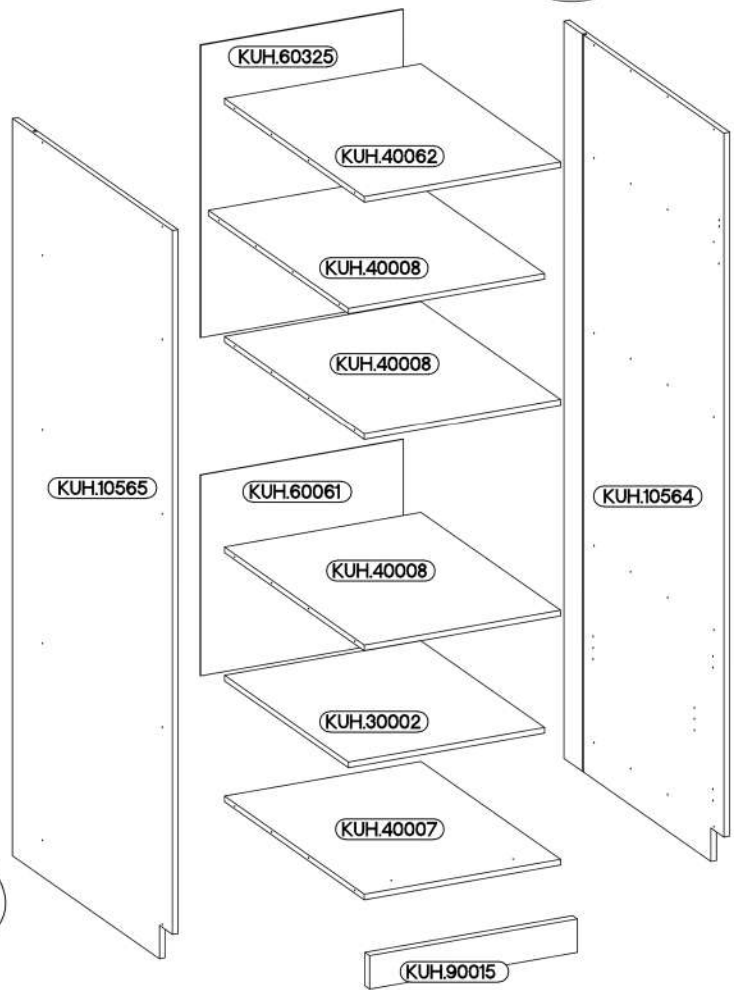

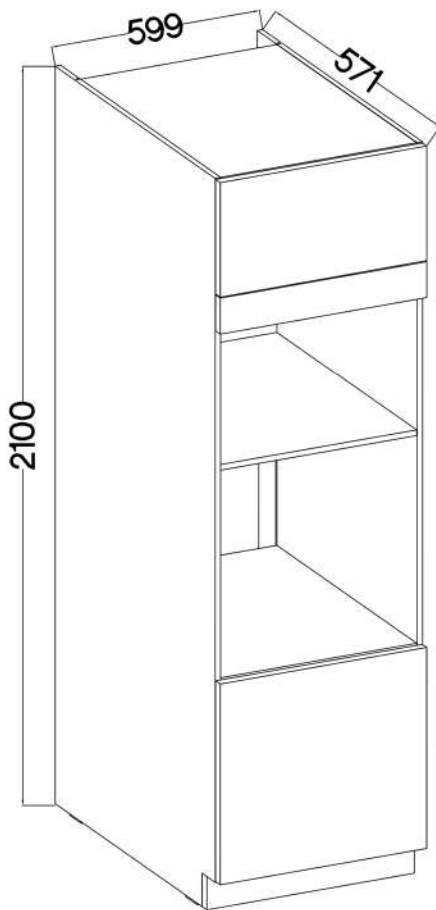

| | |
|--|--------------------------------|
| $\varnothing 8 \times 30 \text{mm}$ A | $6,4 \times 50 \text{mm}$ B |
| 20 | 20 |

| | | | | |
|---|--|---|---|---|
| $\varnothing 6,5 \times 48 \times 16$ F2 | $\varnothing 35/0 \text{mm}$ [CD] HG | $\varnothing 5/19 \text{mm}$ J | J5 | K24 |
| 4 | 4 | 4 | 2 | 2 |
| $120 \times 30 \times 15 \text{mm}$ L25 | $\varnothing 4,0 \times 16 \text{mm}$ O | $\varnothing 4,0 \times 45 \text{mm}$ P1 | $\varnothing 3,5 \times 13 \text{mm}$ P4 | $\varnothing 3,0 \times 20 \text{mm}$ P5 |
| 1 | 1 | 4 | 2 | 10 |
| | | | | P7 |
| | | | | 15-20 |
| | | | | T3 |
| | | | | 2 |

| | |
|--------------|-------------|
| KUH.10564 | 2095x555x16 |
| KUH.10565 | 2095x555x16 |
| KUH.30002 | 566x430x16 |
| KUH.40007 | 567x485x16 |
| KUH.40008 x3 | 567x485x16 |
| KUH.40062 | 567x485x16 |
| KUH.60061 | 570x585x2,5 |
| KUH.60325 | 830x585x2,5 |
| KUH.90015 | 599x95x16 |

1

| | |
|--|---|
| 6.5x48x16 | ∅8x30mm |
|  F2 |  A |
| 4 | 20 |

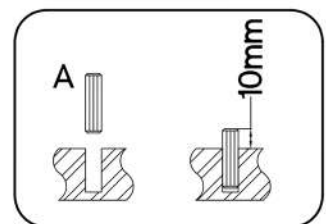
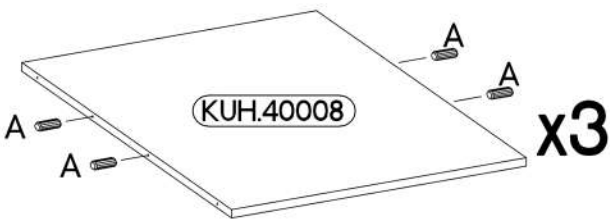
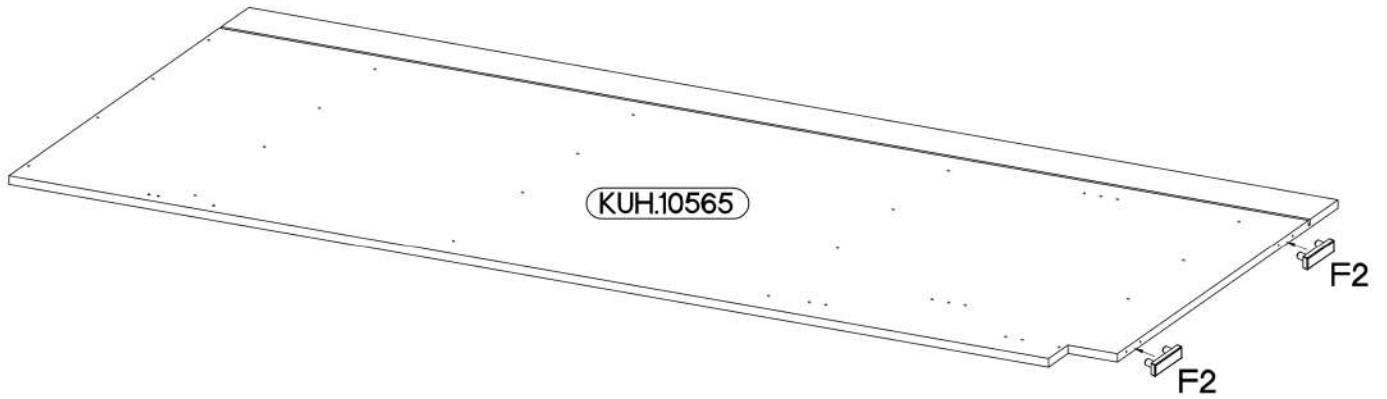
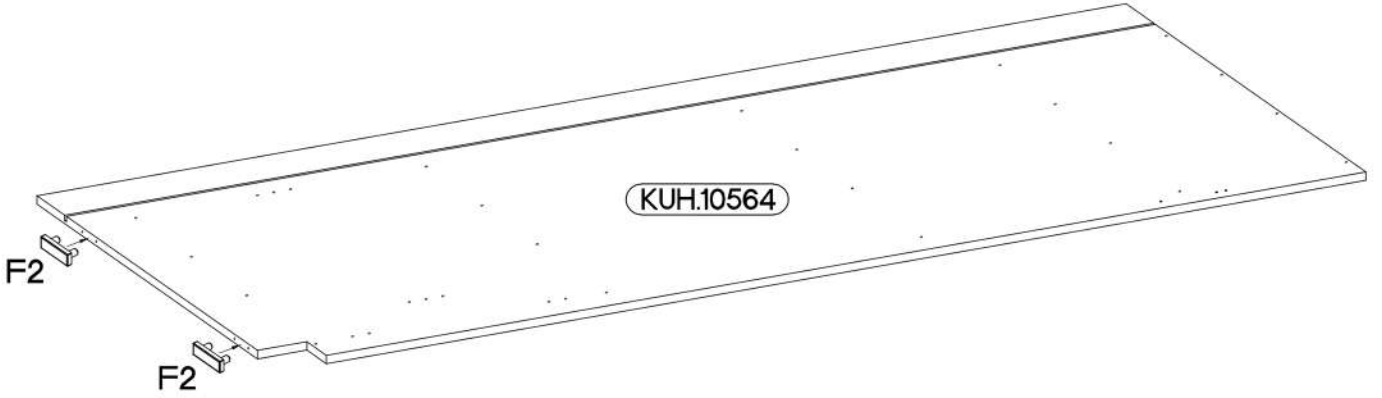
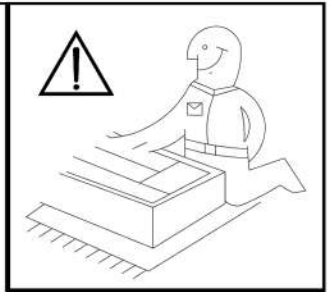
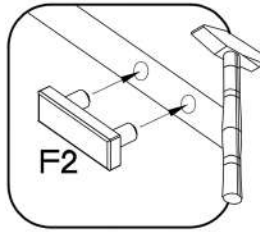

2

6,4 x 50mm



B

10



O

1



E1

10

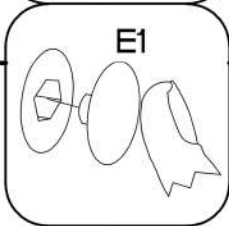
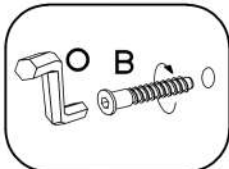
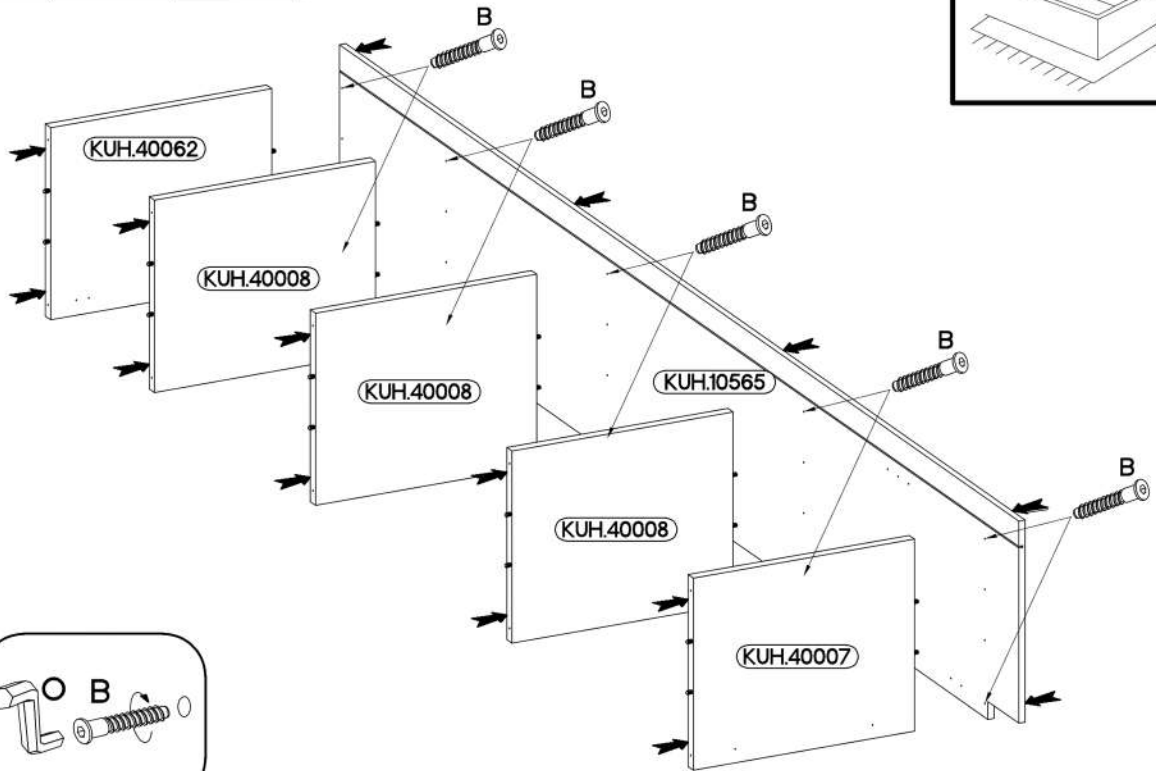

3

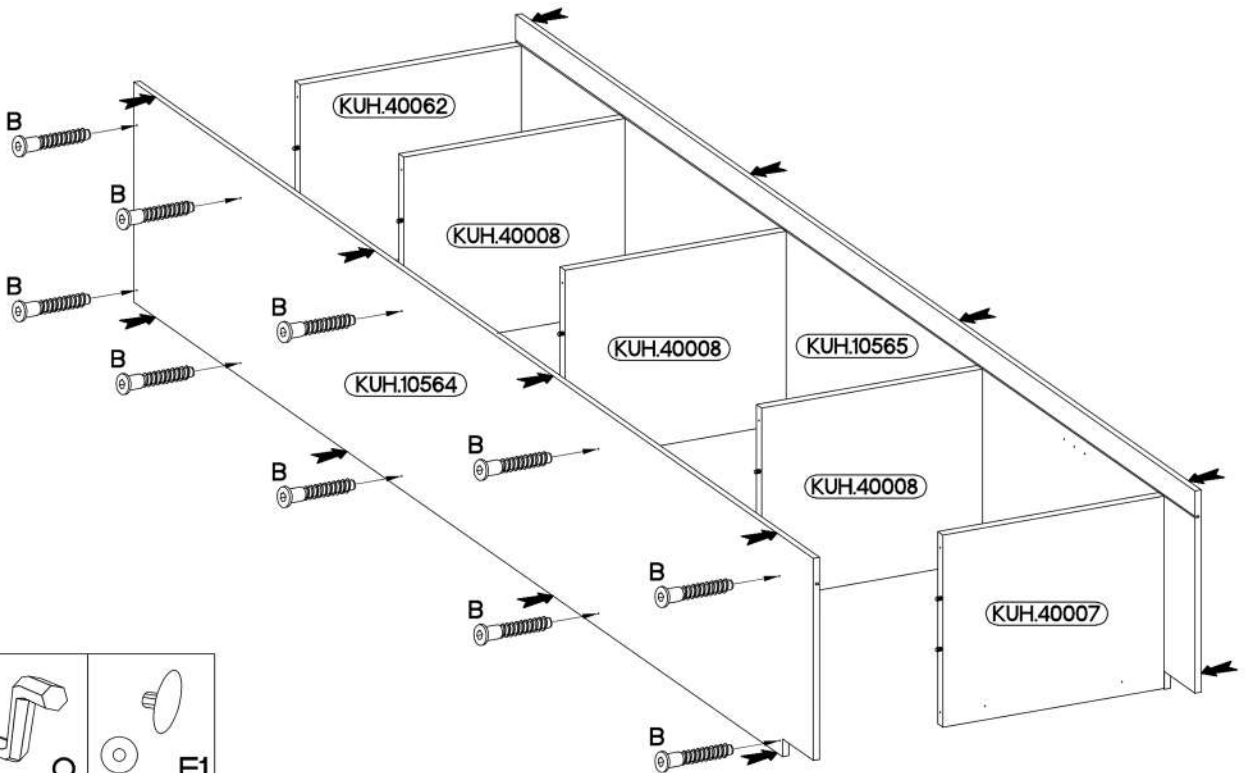

6,4 x 50mm



B

10



O

1

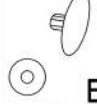

E1



10

4

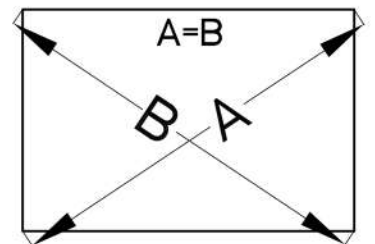
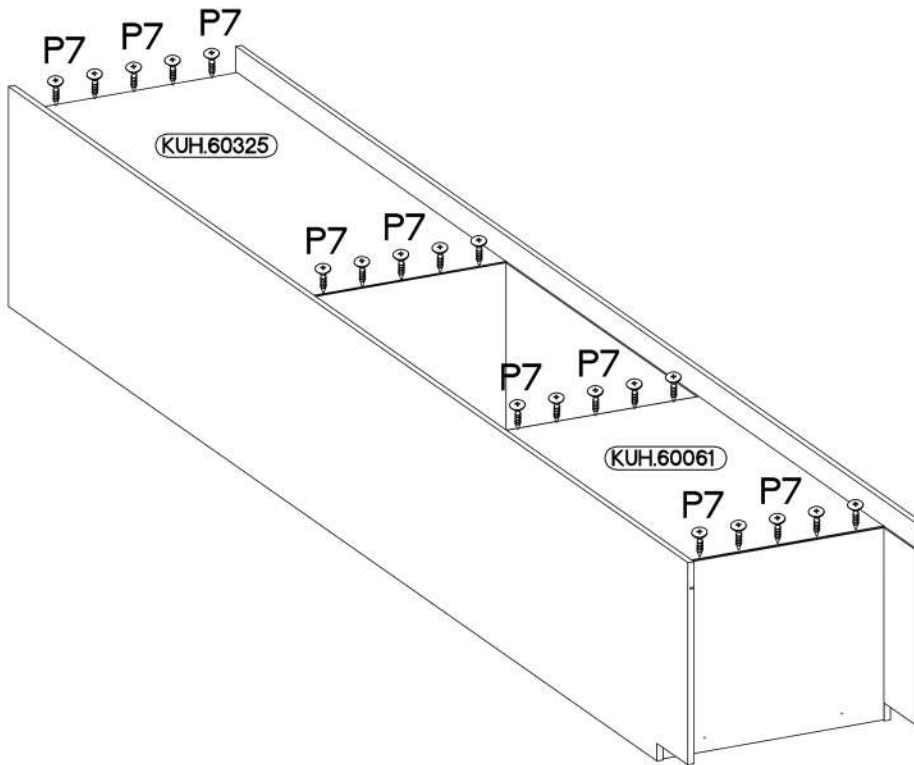
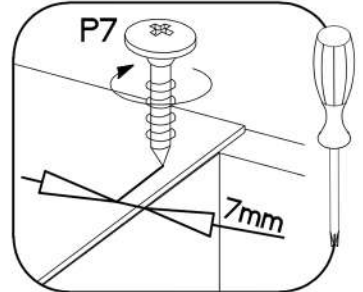
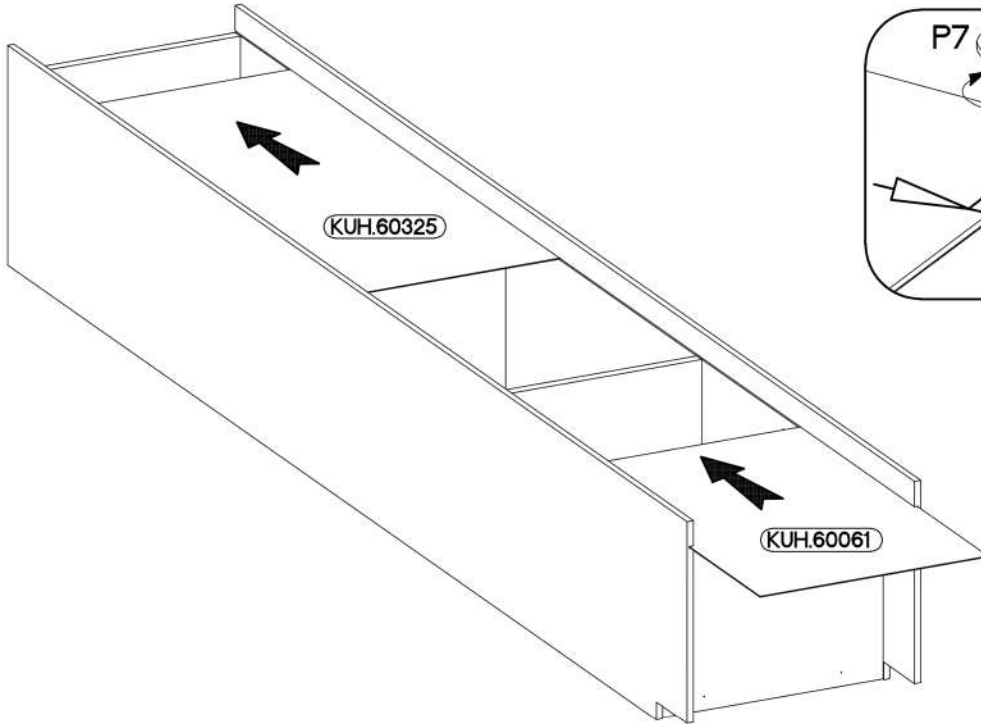
3.0x20mm
P7
15-20



5

| | |
|--|---|
|  +4.0x45mm P4 |  E9 |
| 2 | 2 |

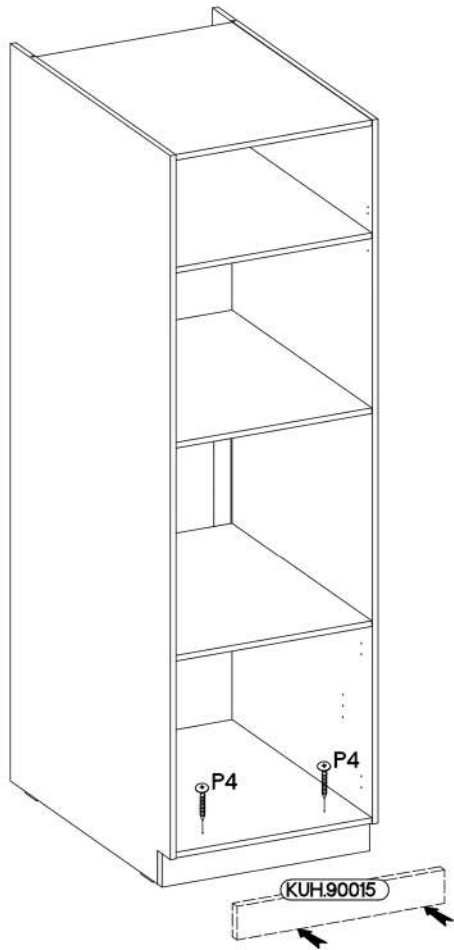



6

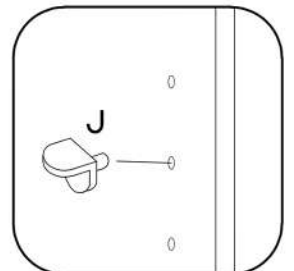
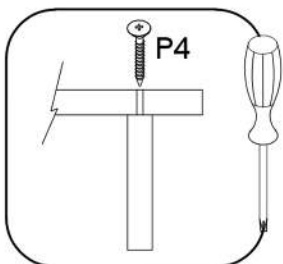
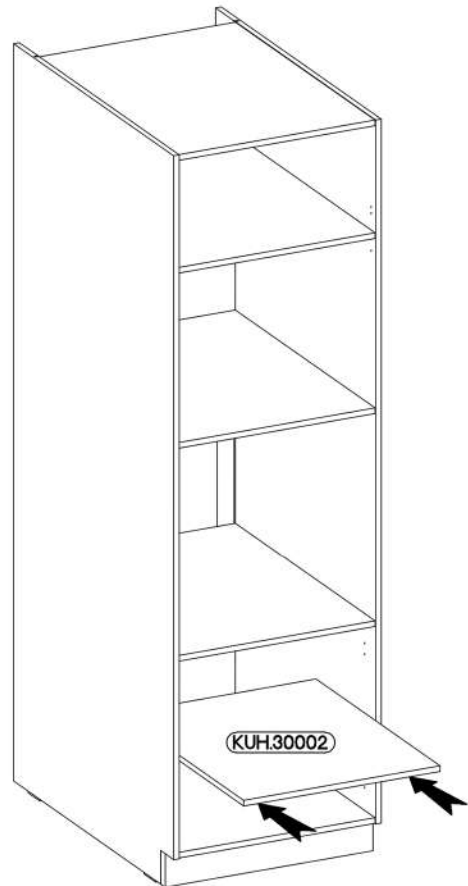

| |
|--|
|  +5/19mm J |
| 4 |

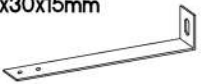

7

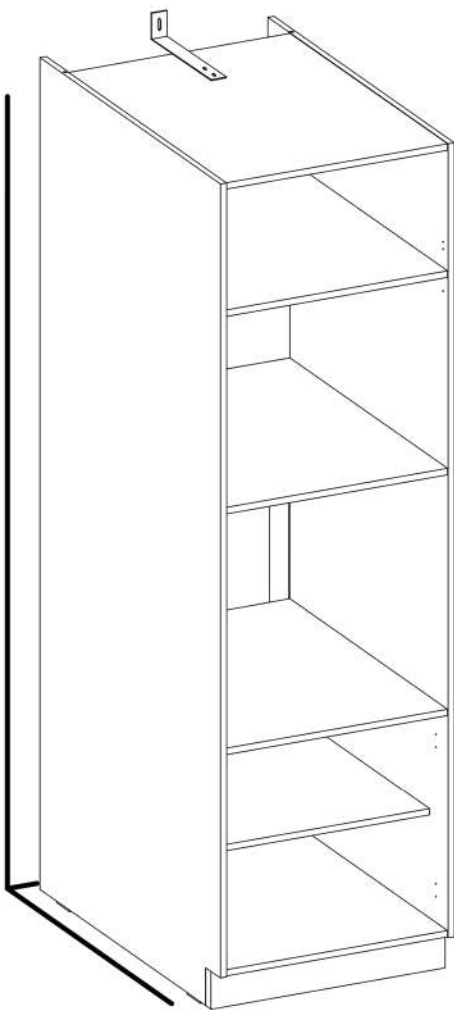
| | | | |
|---|-----|---|----|
| 120x30x15mm | 1 | 3.5x13mm | 2 |
|  | L25 |  | P5 |

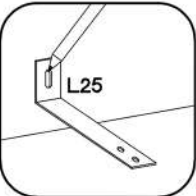
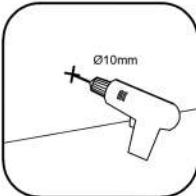

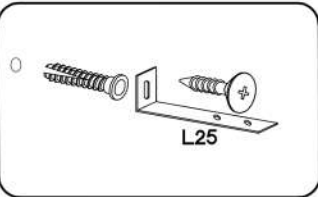
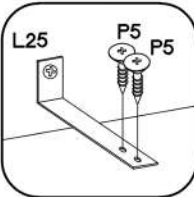
1. 
2. 
3. 
4. 
5. 

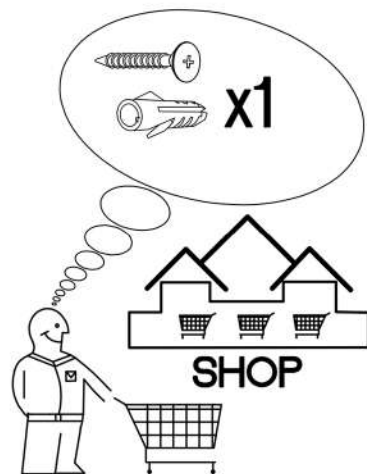
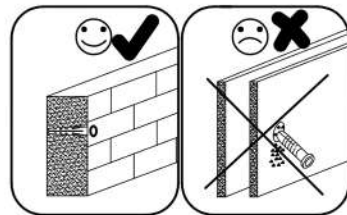

8

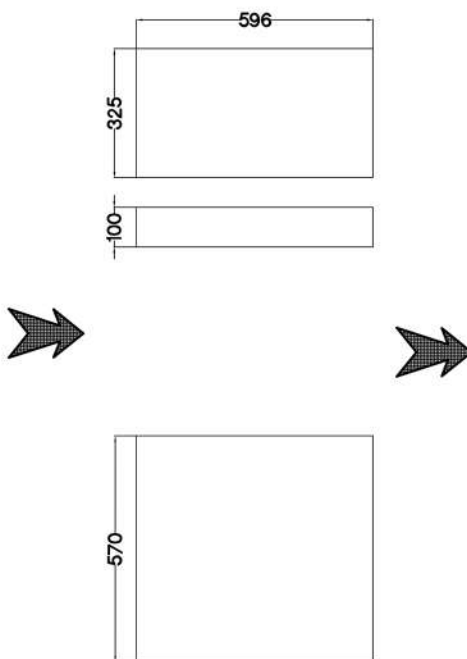
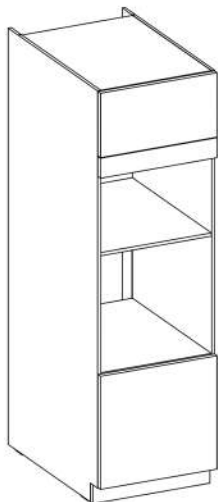

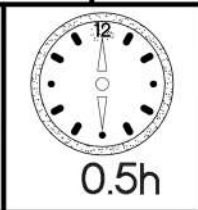
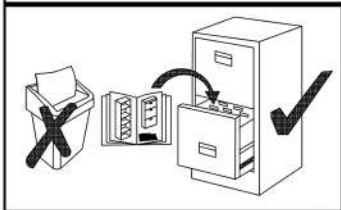
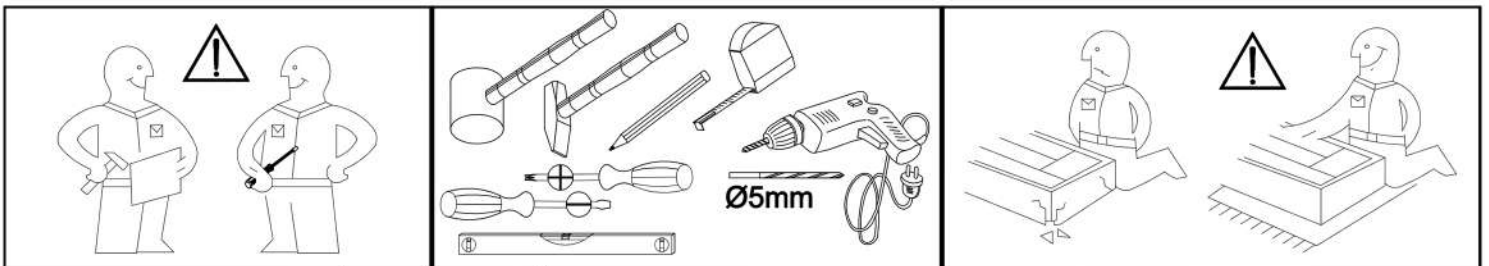



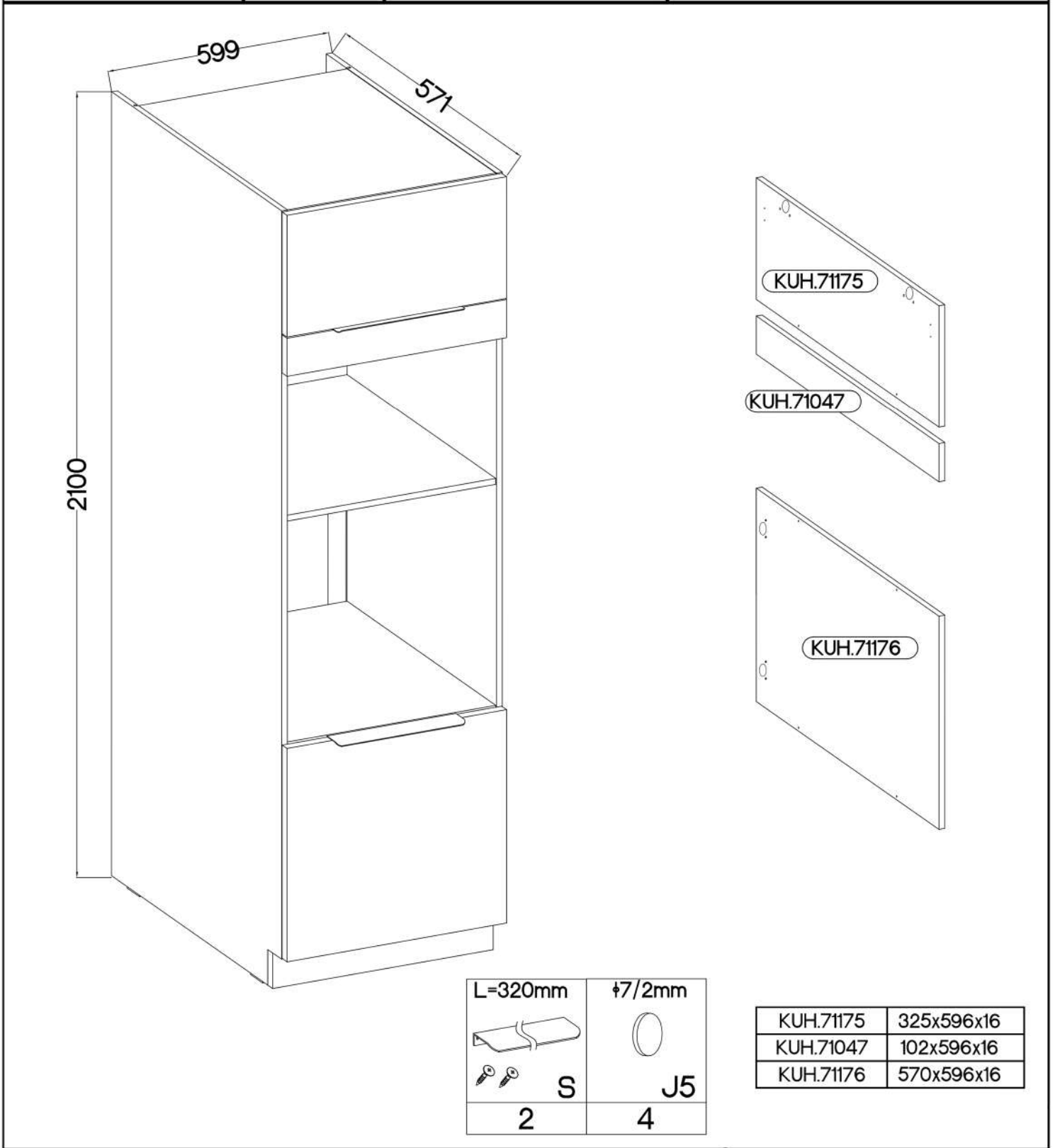
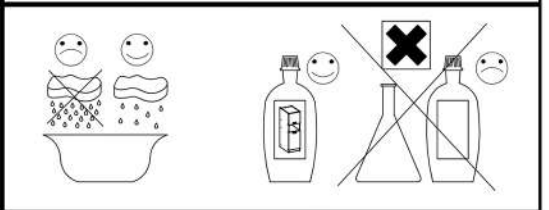

60 DPM-210 2F



| | |
|---------|--------|
| L=320mm | ±7/2mm |
| | |
| S | J5 |
| 2 | 4 |

| | |
|-----------|------------|
| KUH.71175 | 325x596x16 |
| KUH.71047 | 102x596x16 |
| KUH.71176 | 570x596x16 |

1

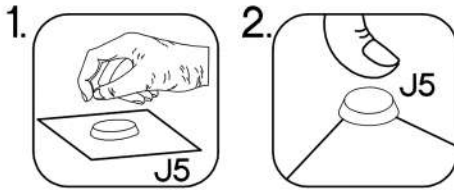
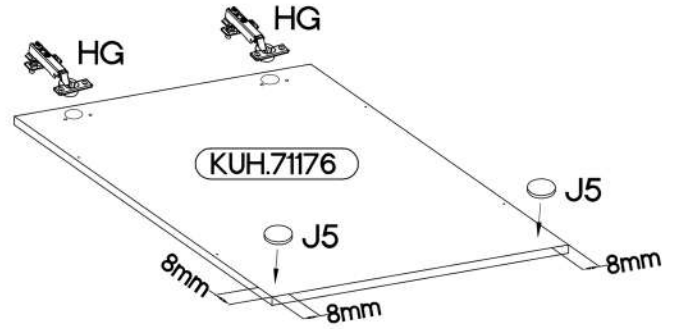
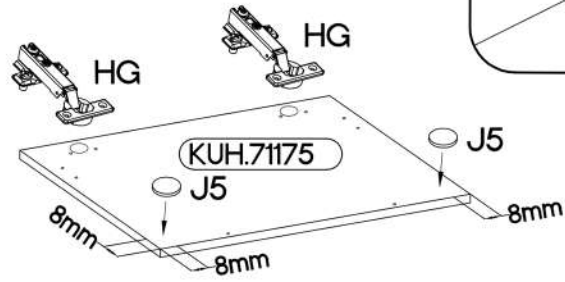
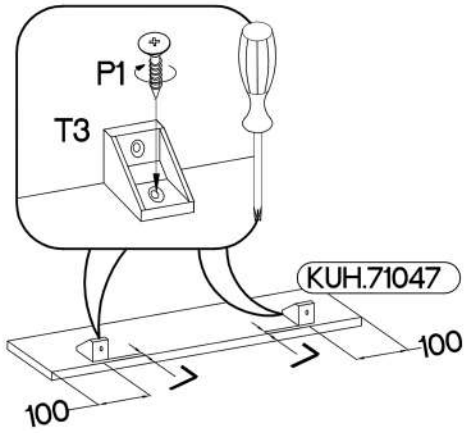
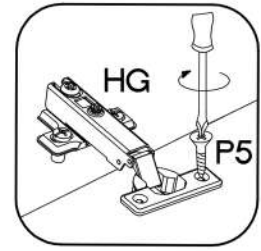

| | | | | |
|--|---|--|---|--|
|  +35/0mm [CD] HG 4 |  +3.5x13mm P5 8 |  T3 2 |  +4.0x16mm P1 2 |  +7/2mm J5 4 |
|--|---|--|---|--|

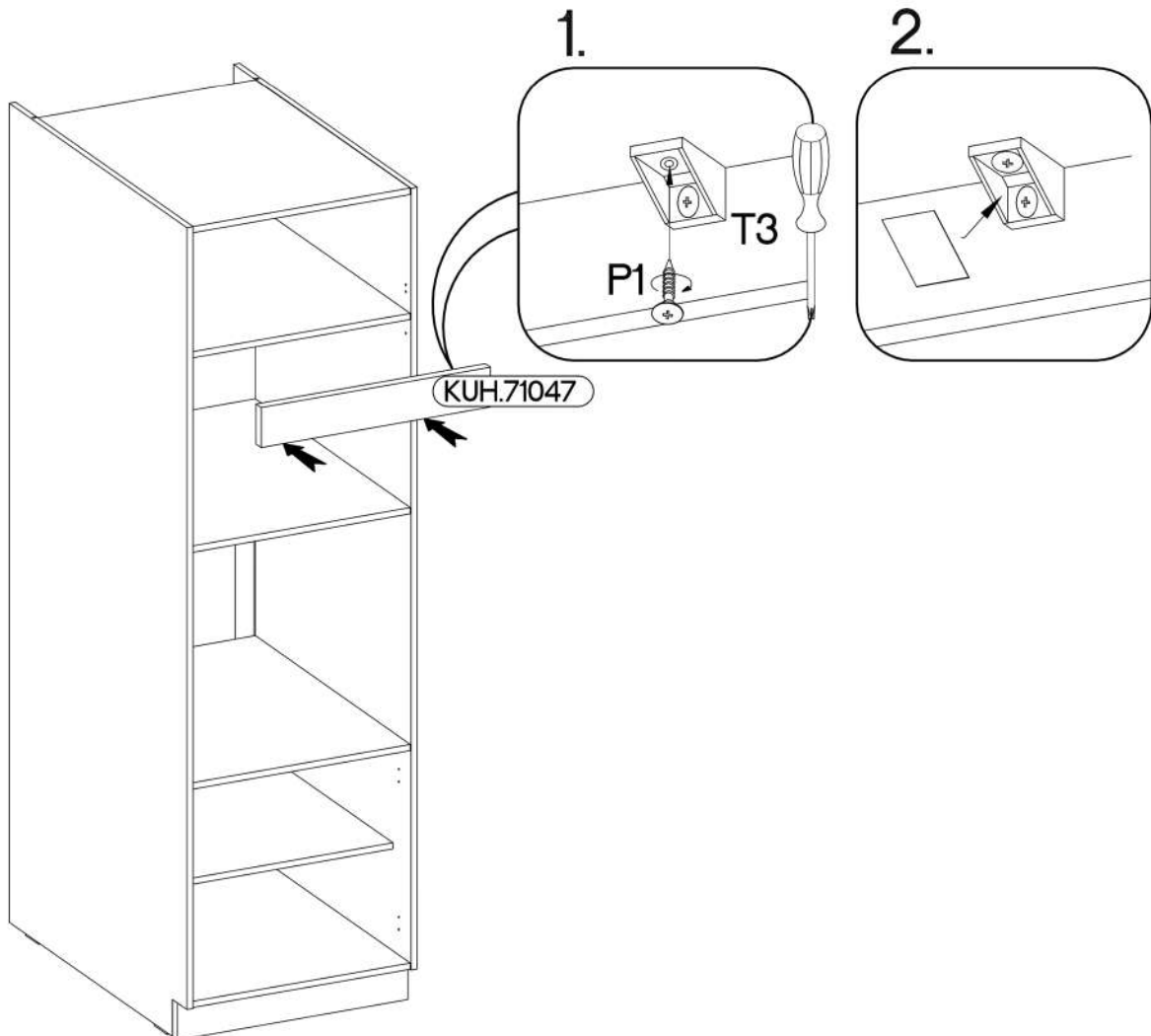

2

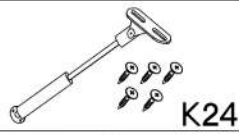

3

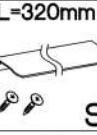
| | | |
|---|--|--|
|  K24 2 |  J5 2 |  L=320mm S 2 |
|---|--|--|

