

# ARSANY 60 LO-210 2F

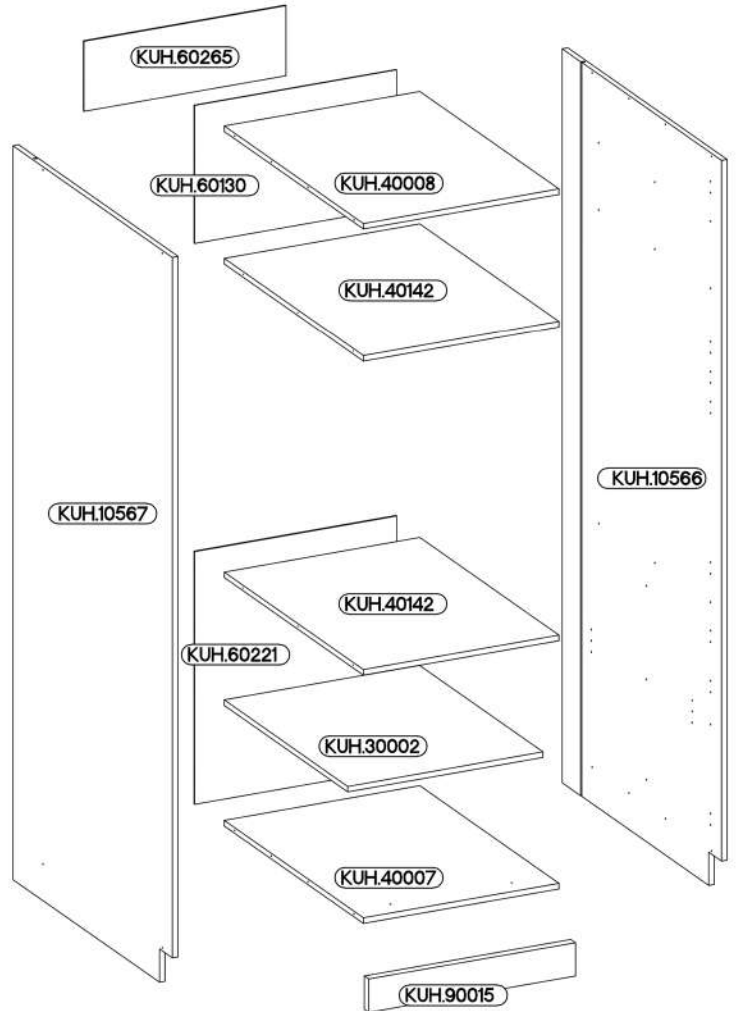

KUH.10566	2095x555x16
KUH.10567	2095x555x16
KUH.30002	566x430x16
KUH.40007	567x485x16
KUH.40008	567x485x16
KUH.40142 x2	567x485x16
KUH.60130	393x585x2,5
KUH.60221	721x585x2,5
KUH.60265	200x585x2,5
KUH.90015	599x95x16

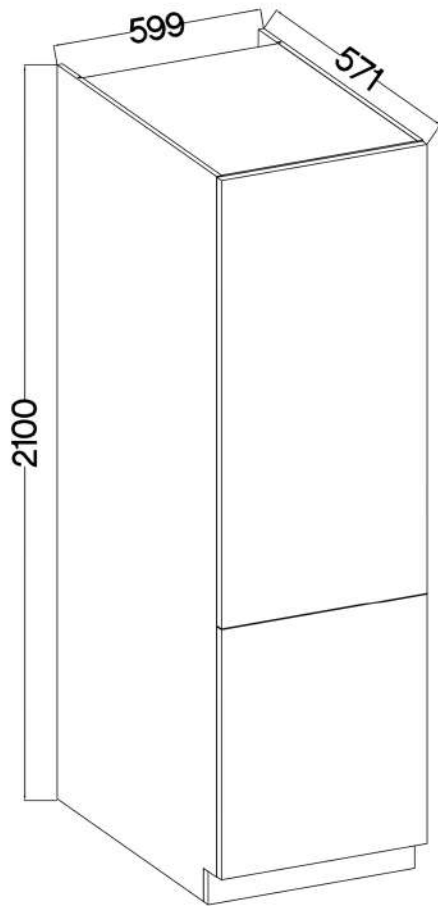

8	8	12
A	B	C

D2	E	E1	E9	F2	HG	J
12	12	8	2	4	5	4
L25	O	P1	P4	P5	P7	T4
1	1	16	2	12	15-20	4

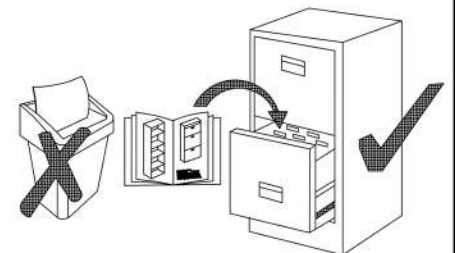

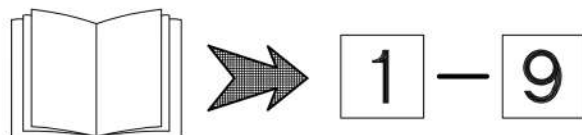
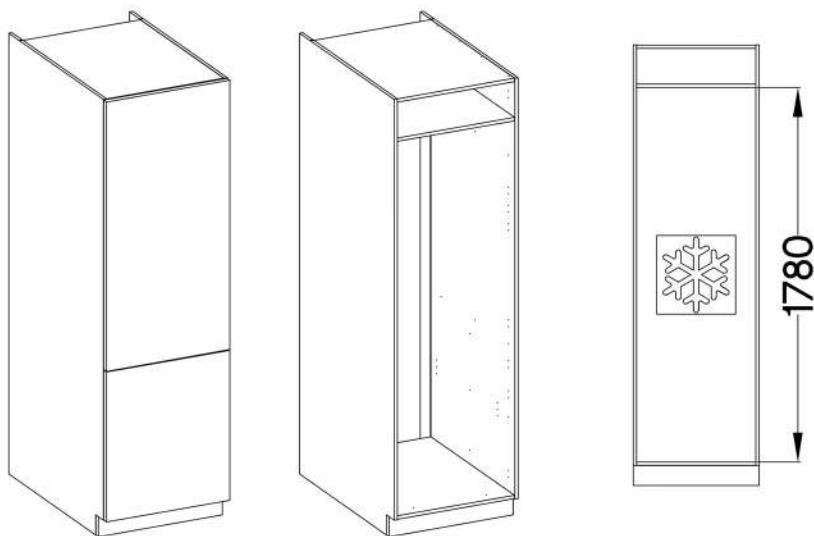

## WARIANT B

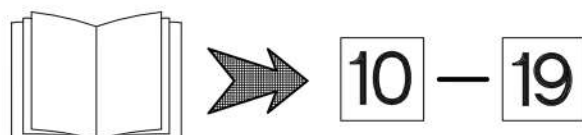
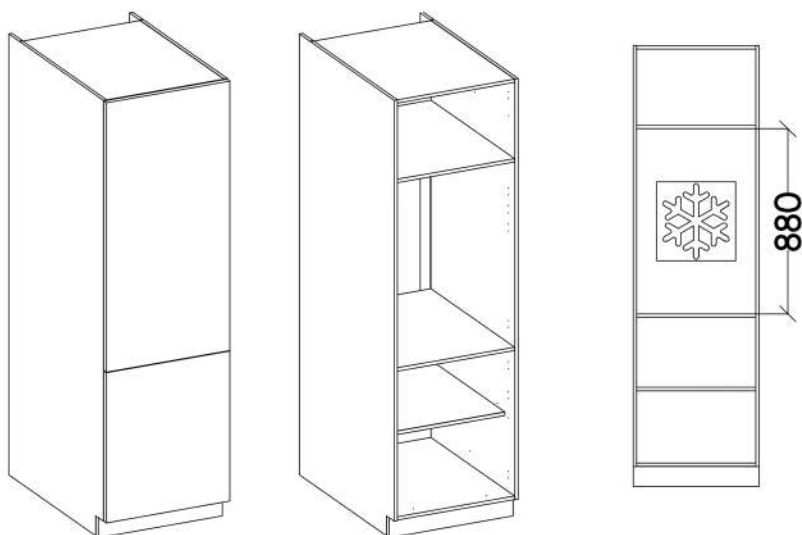

# 1

## WARIANT A

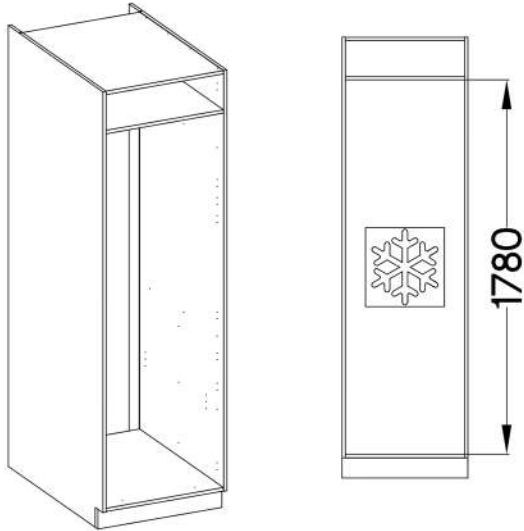

 A	 F2
8 L=20mm	4 H5/H2mm
 D2	 C
6	6

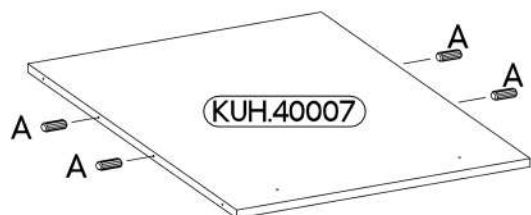
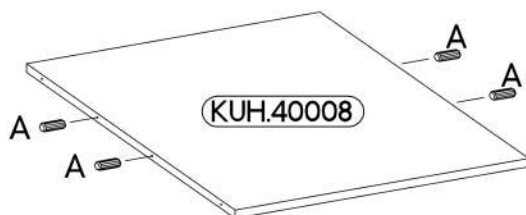
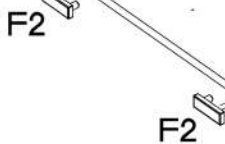
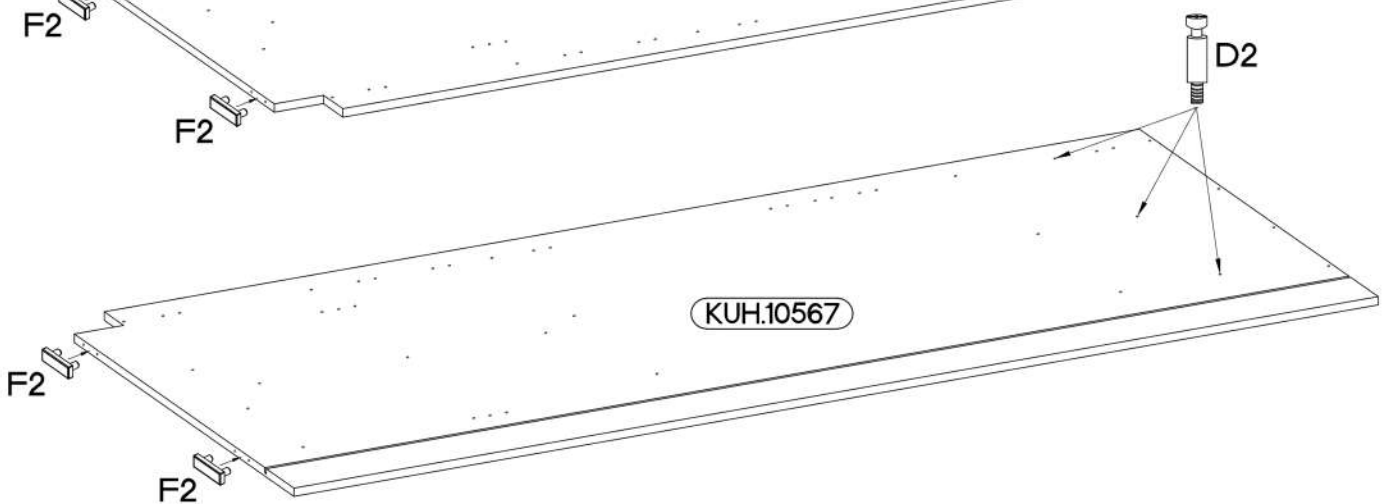
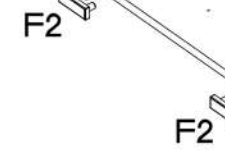
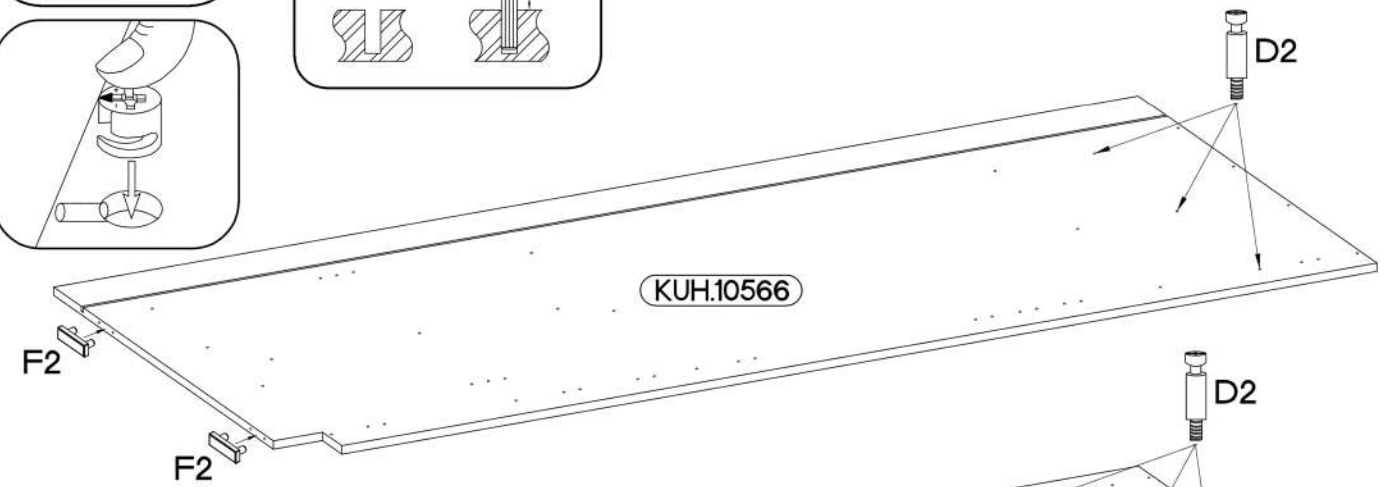
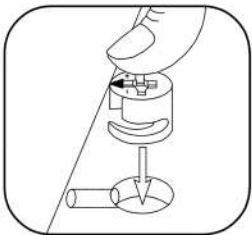
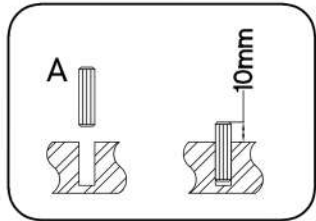
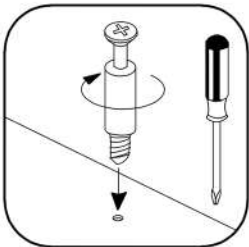
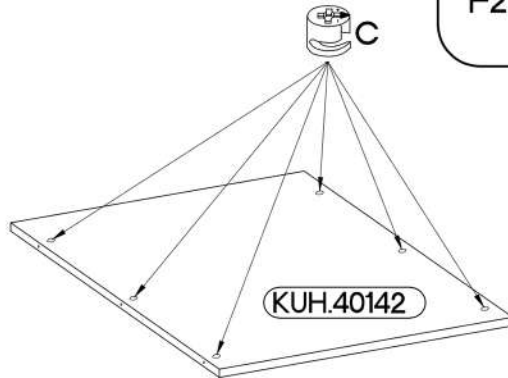
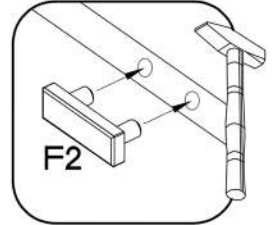
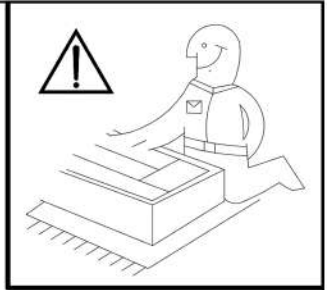

2

6,4 x 50mm



4



1



4

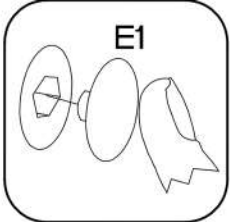
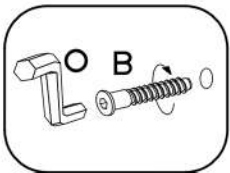
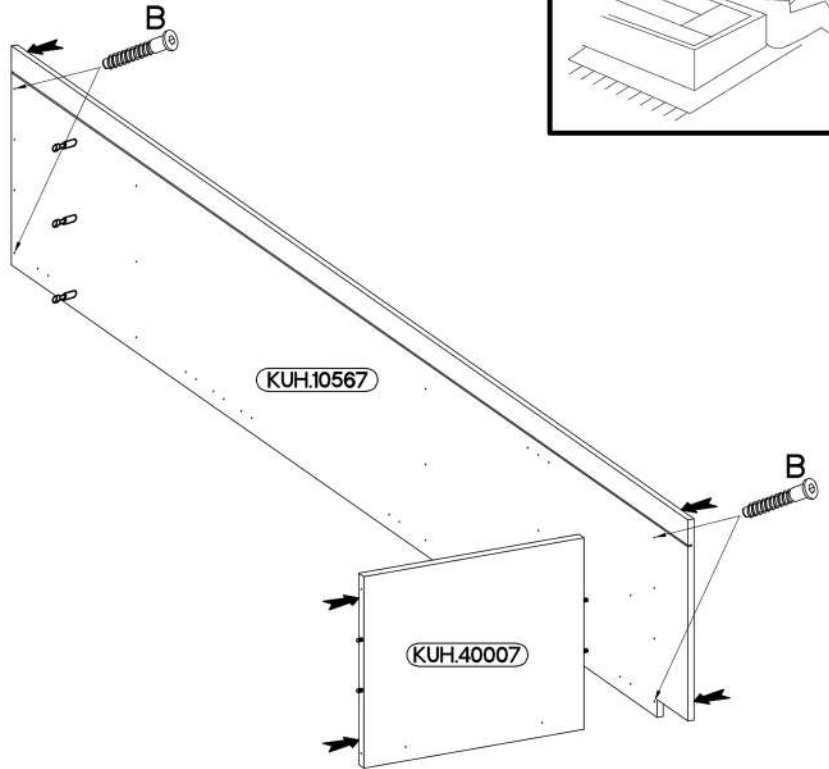
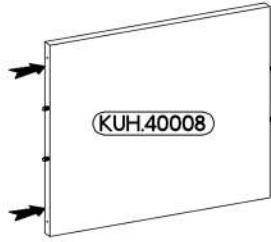
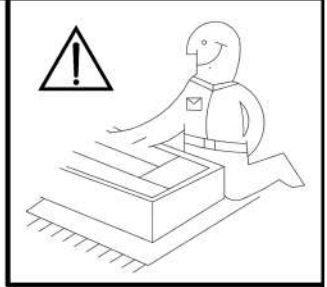



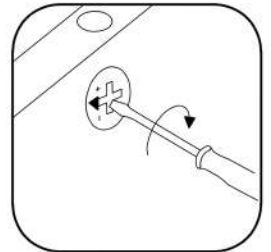
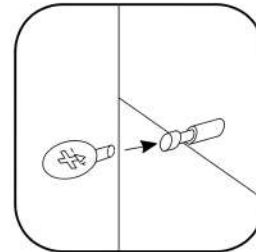
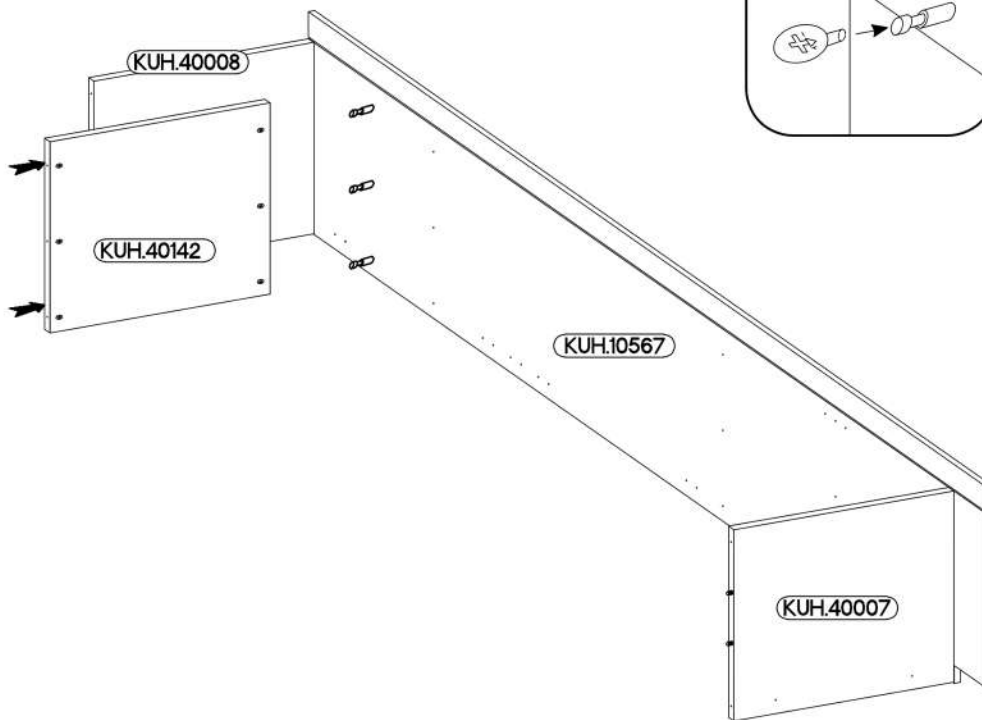

3





# 4

6,4 x 50mm

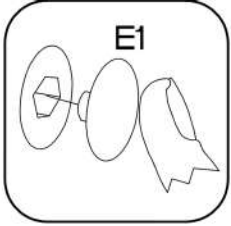
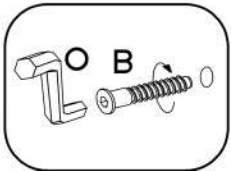
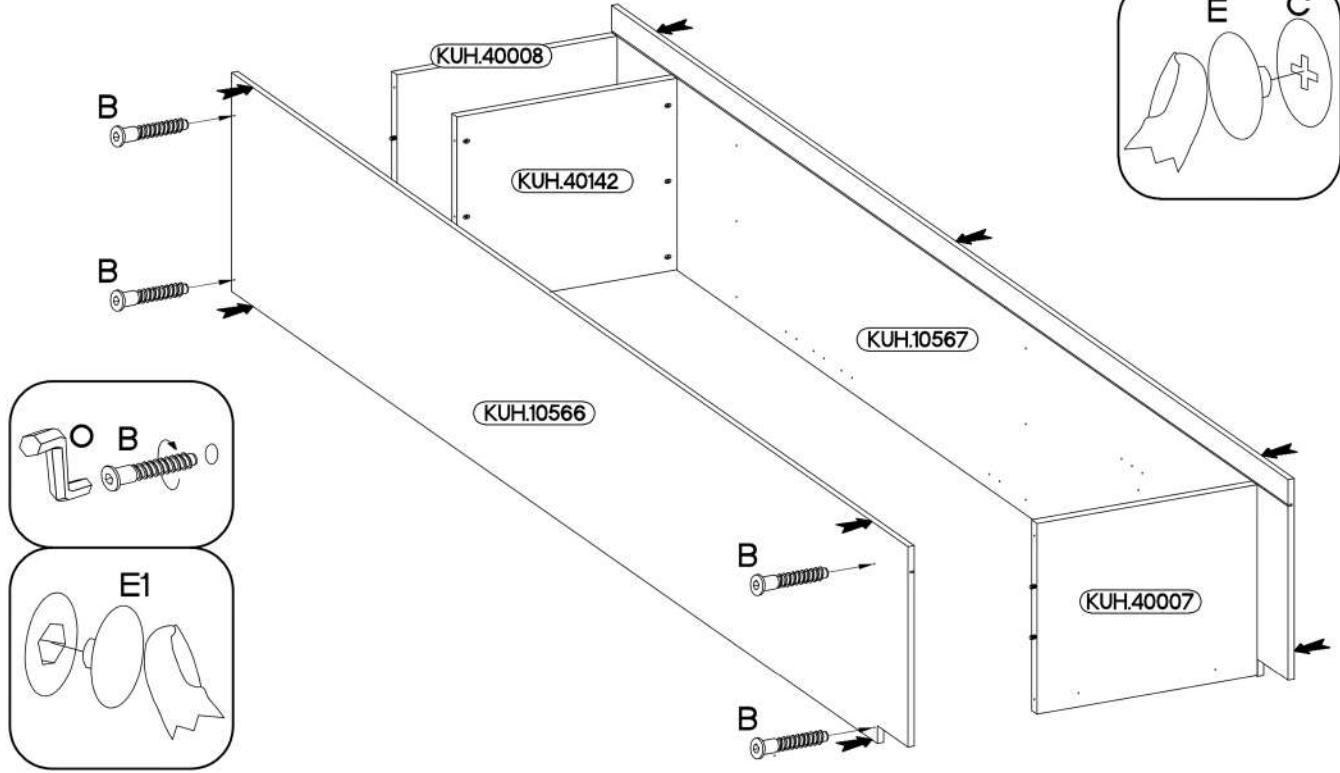
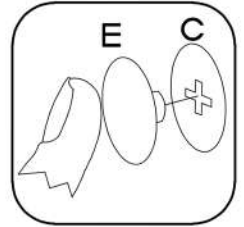
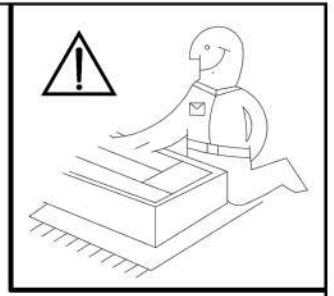
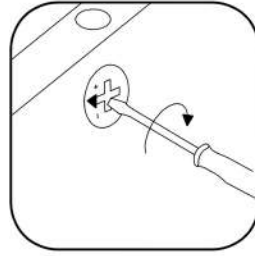
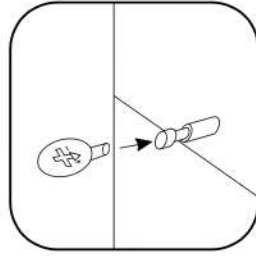
			
B	O	E1	E
4	1	4	6



# 5

	
T4	P1
4	16

4.0x16mm

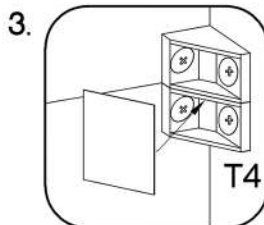
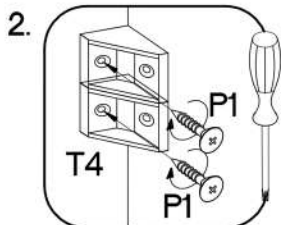
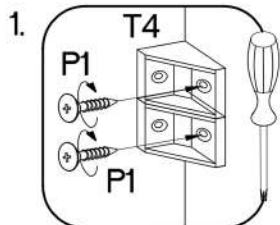
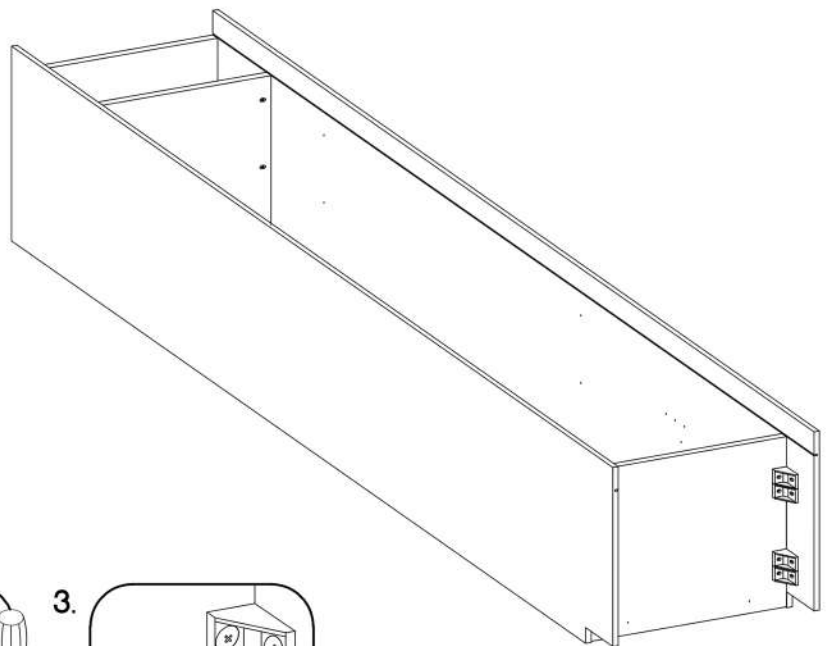
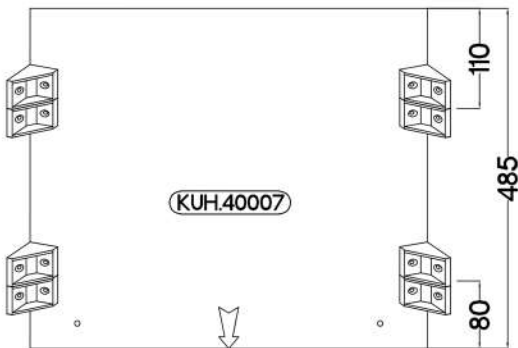

6

∅3.0x20mm



P7

8-10

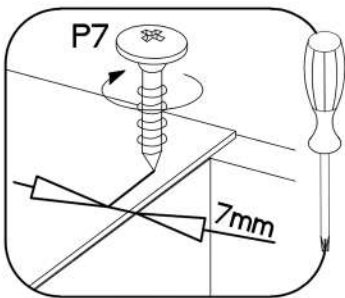
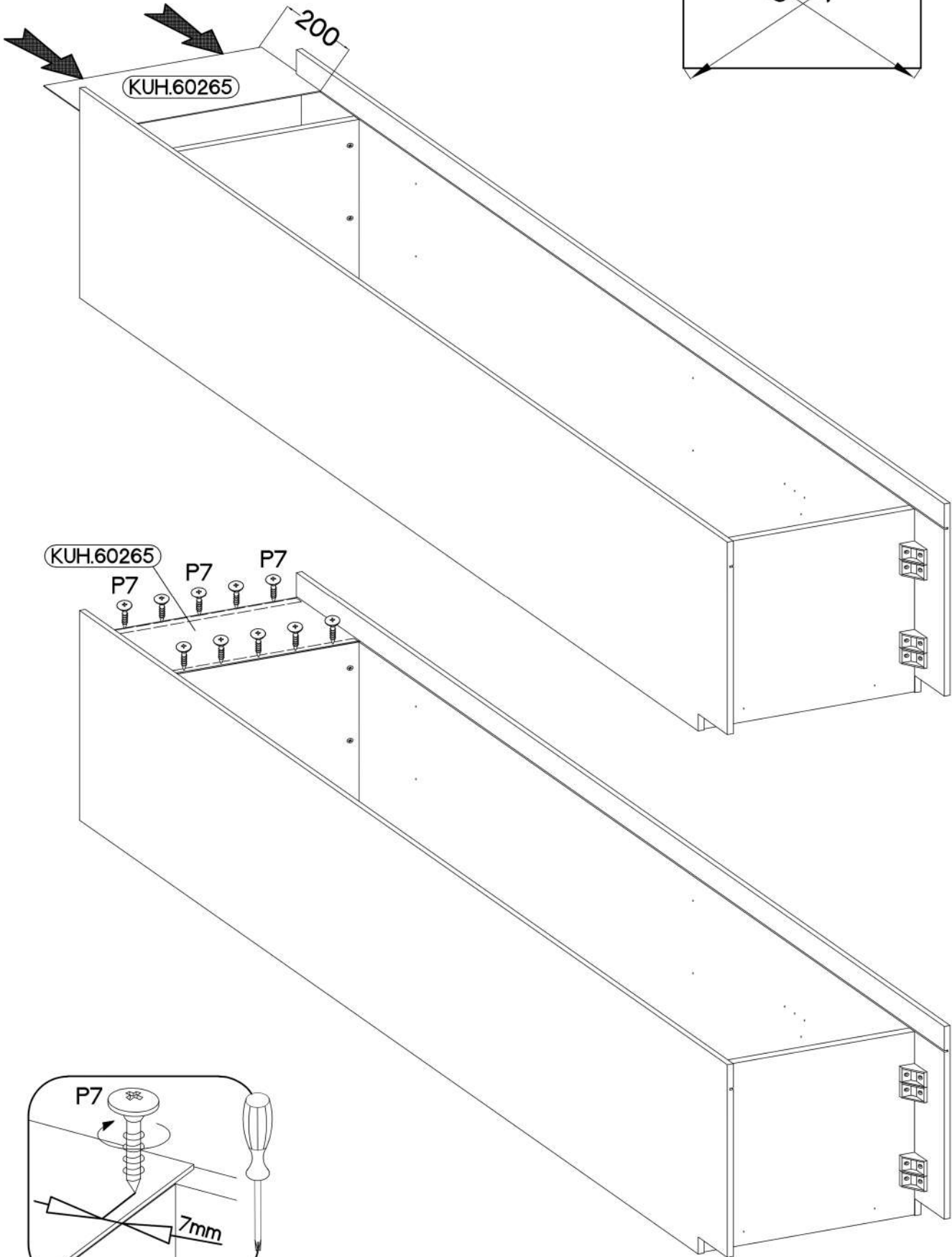
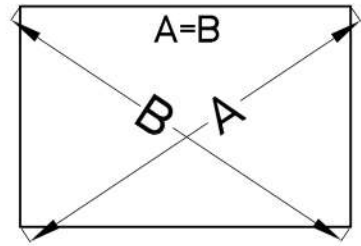

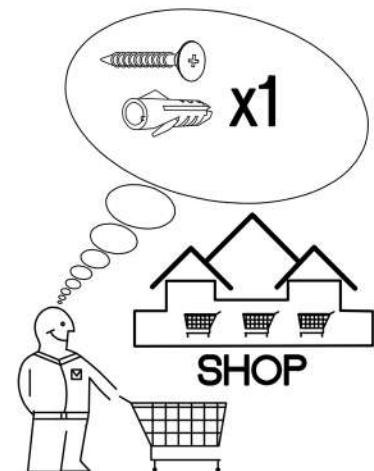
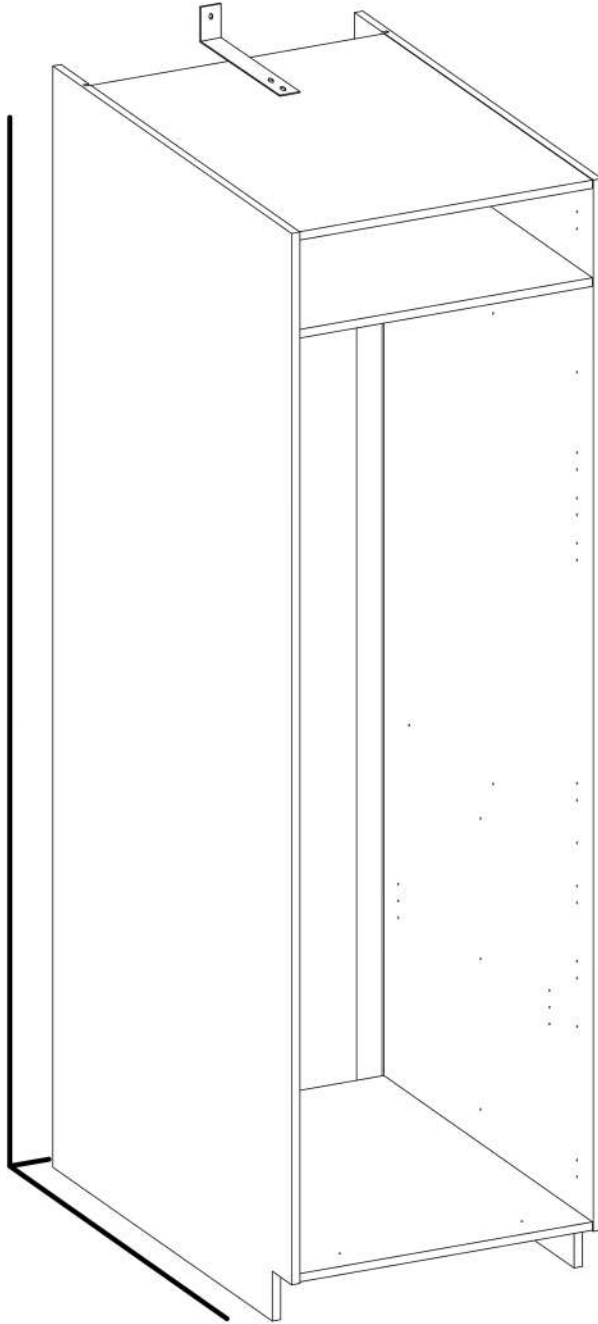
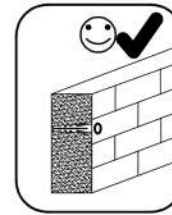
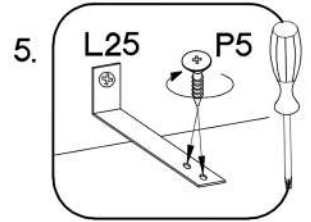
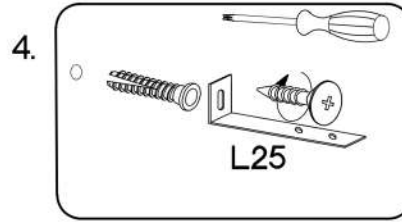
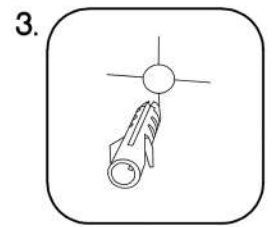
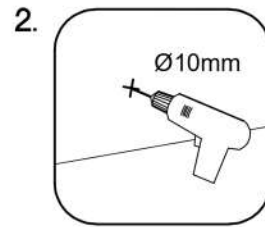
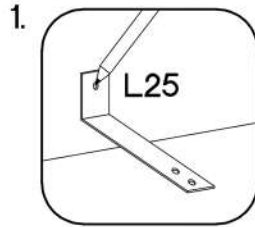
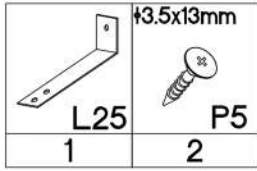

7

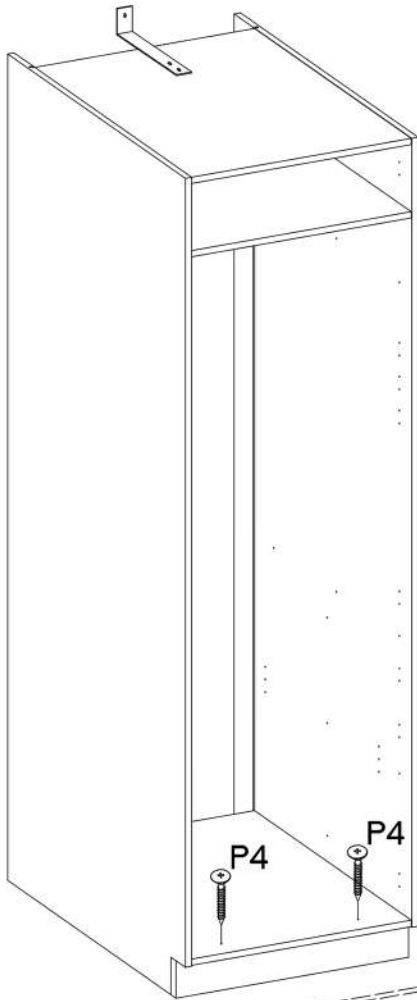

8



4.0x45mm		
	P4	E9
	2	2

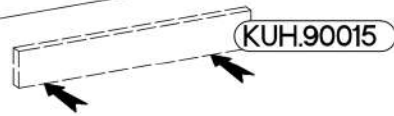
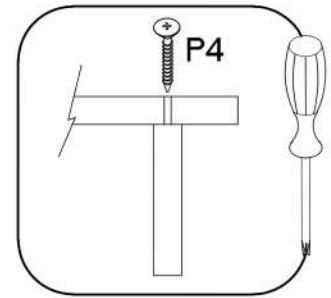

9

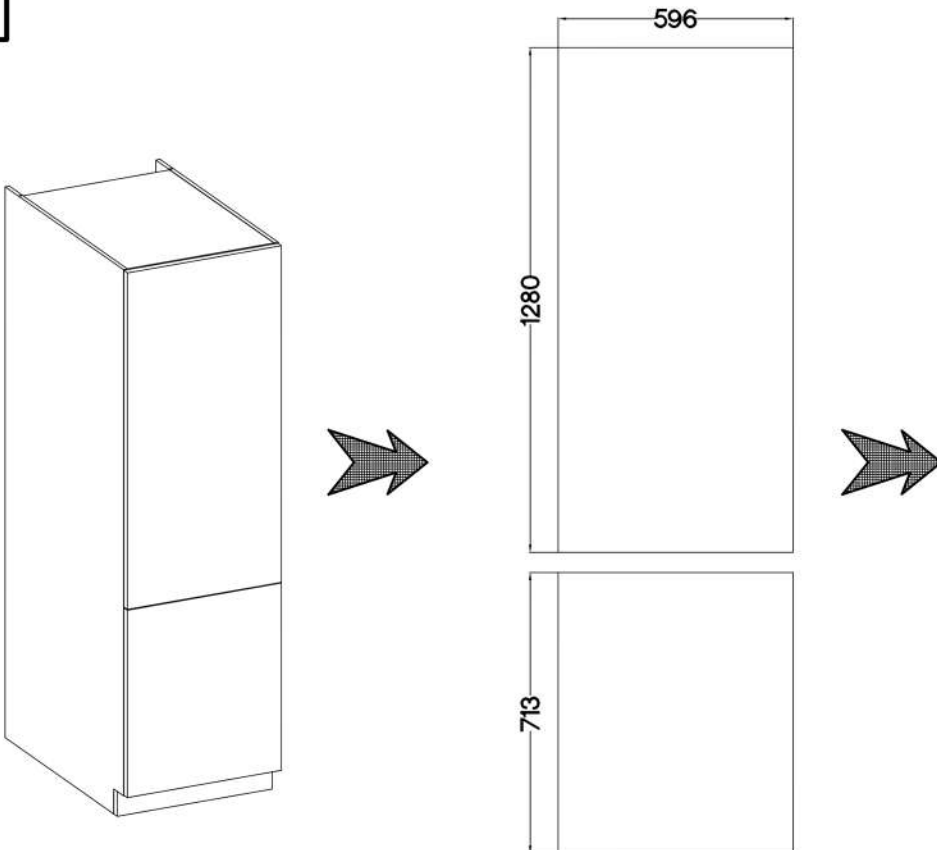

# 10

## WARIANT B

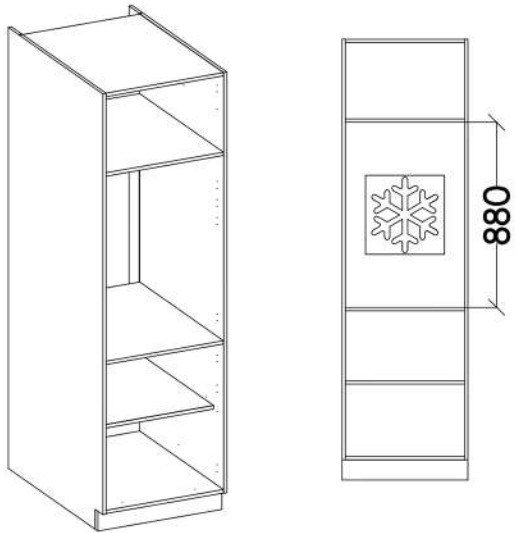

 A	 F2
8 L=20mm  D2	4 H5/H2mm  C
12	12

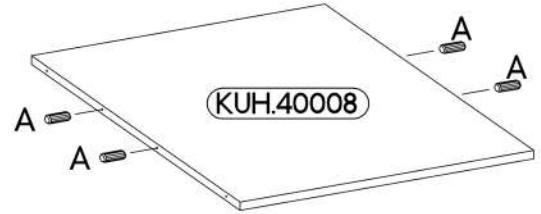
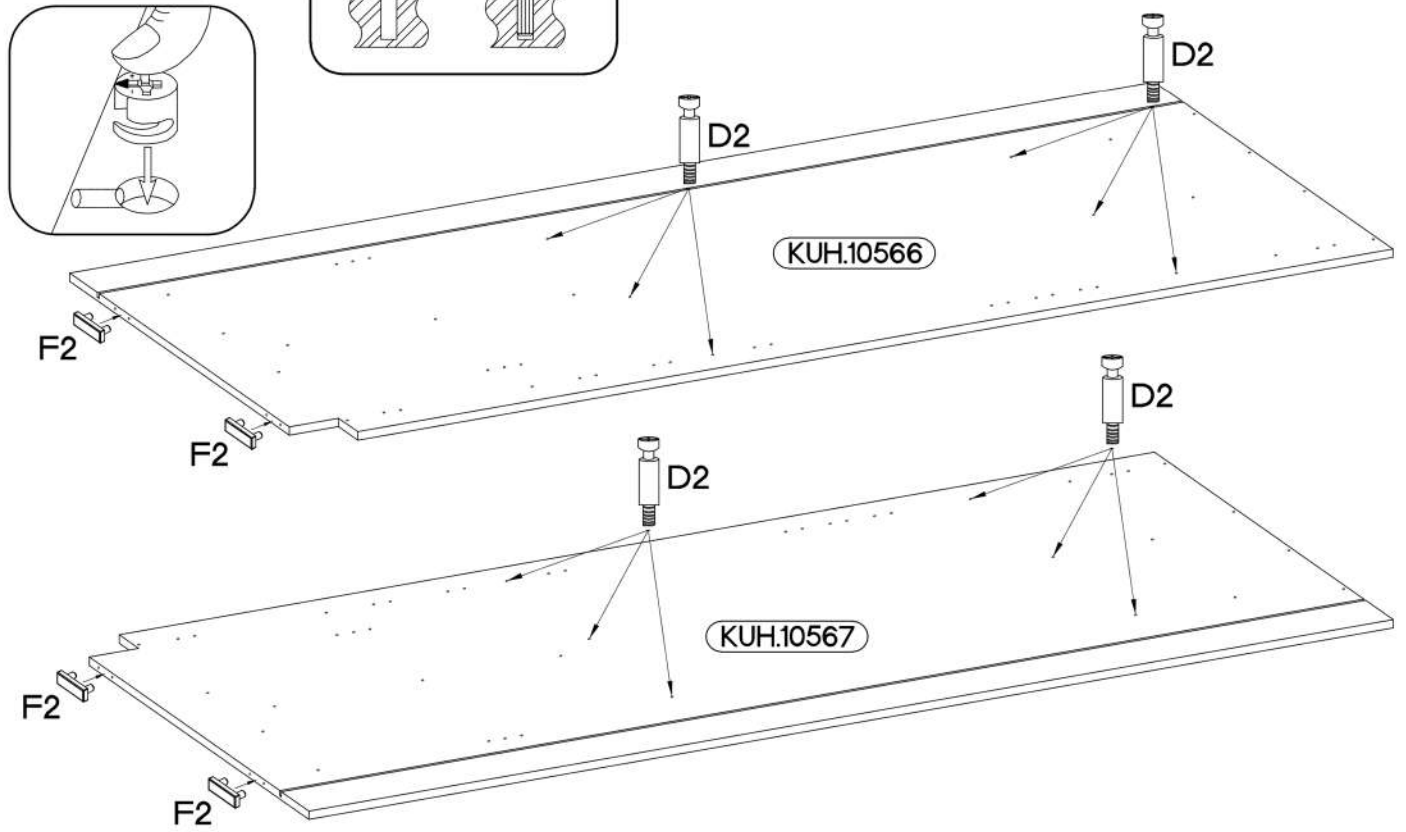
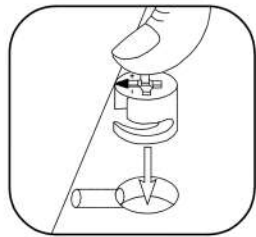
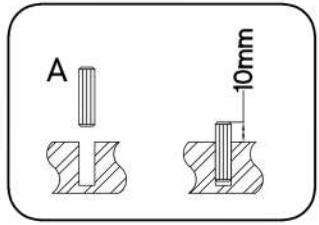
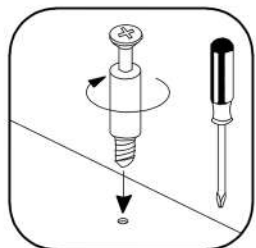
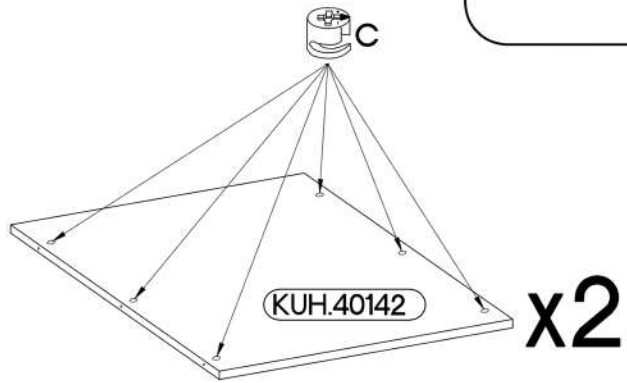
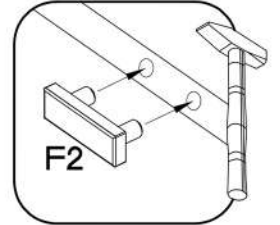
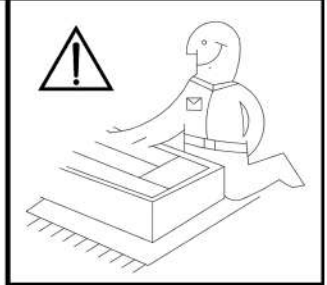

# 11

6,4 x 50mm



B

4



O

1



E1

4

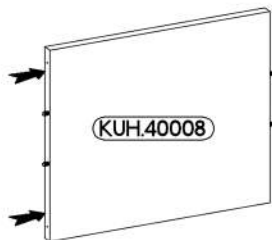
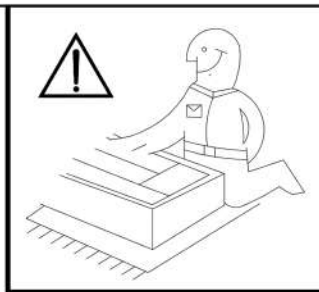

KUH.40008

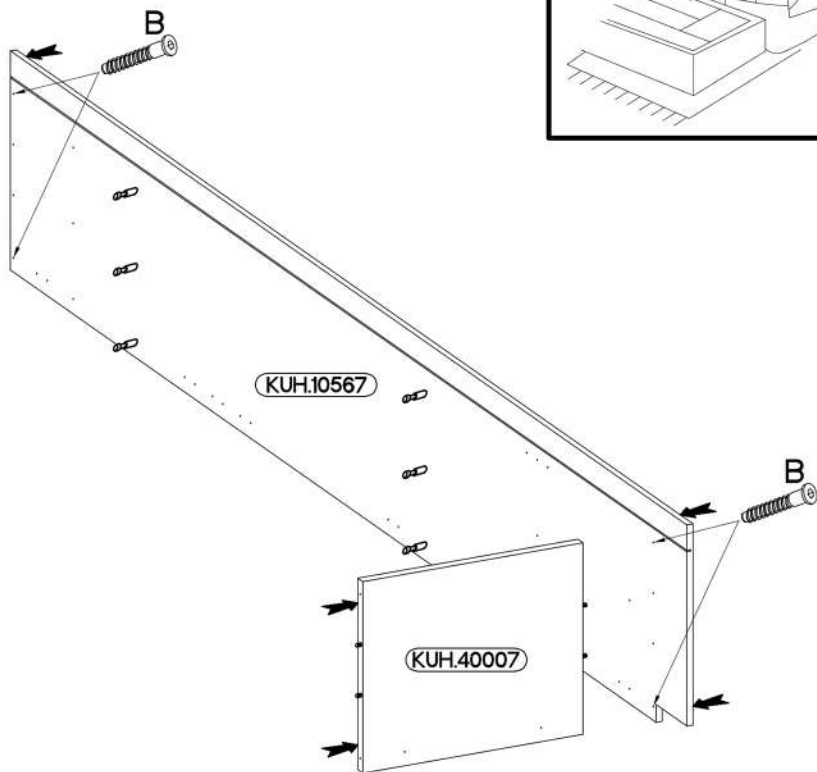

KUH.10567

KUH.40007

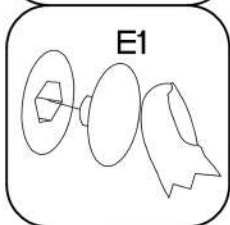

# 12

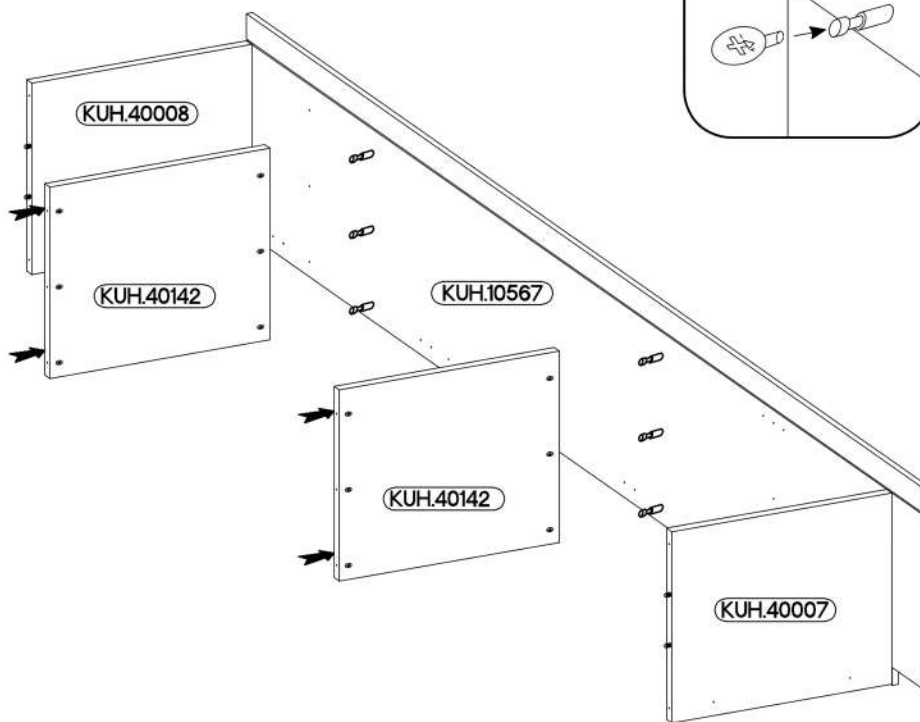

KUH.40008

KUH.40142

KUH.10567



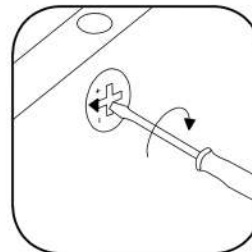
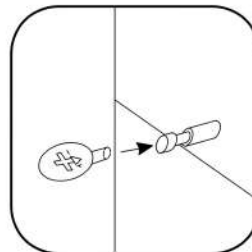

KUH.40142

KUH.40007





# 13

6,4 x 50mm

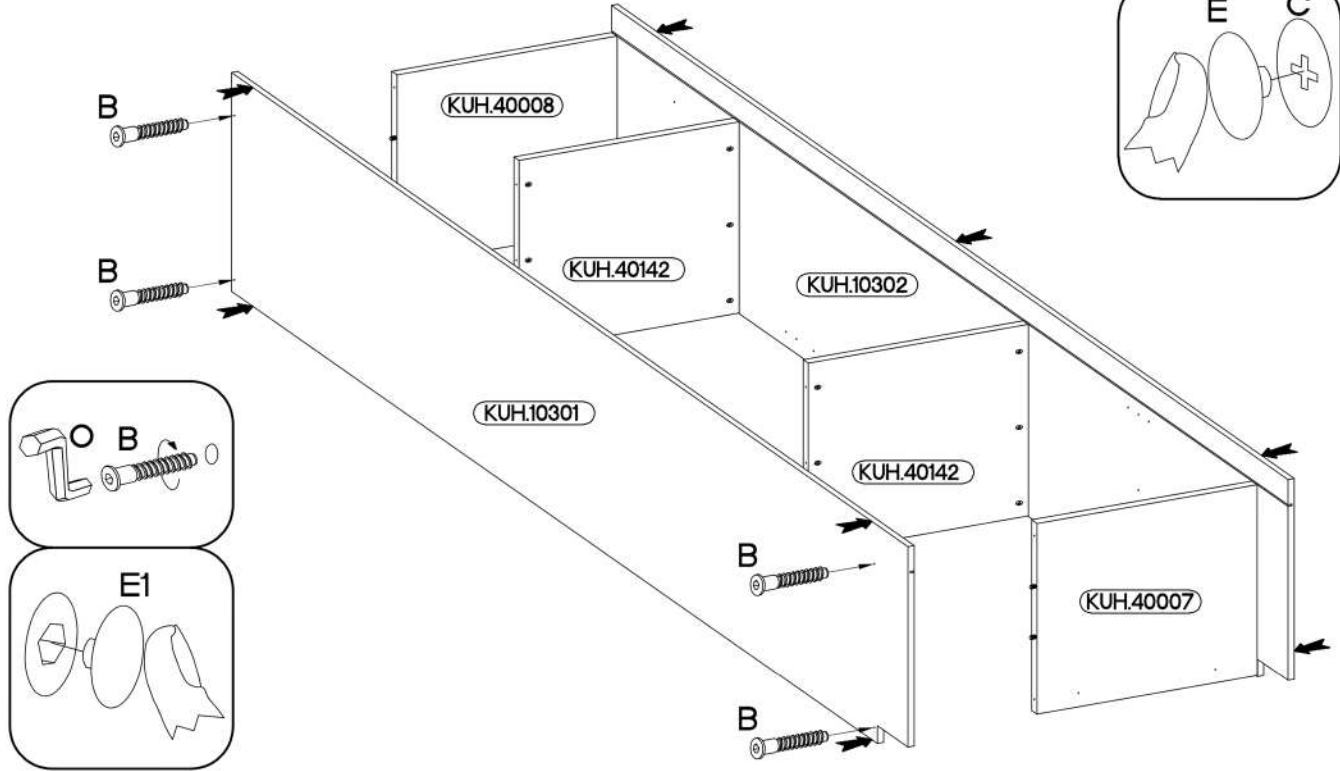
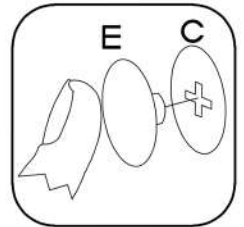
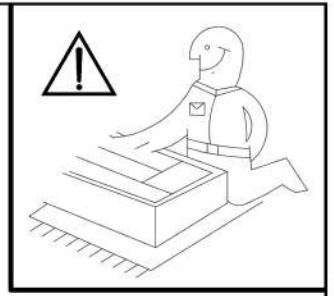
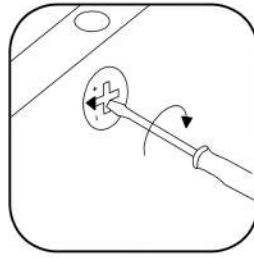
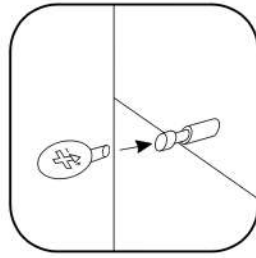
			
B	O	E1	E
4	1	4	12



# 14

	
T4	P1
4	16

4.0x16mm

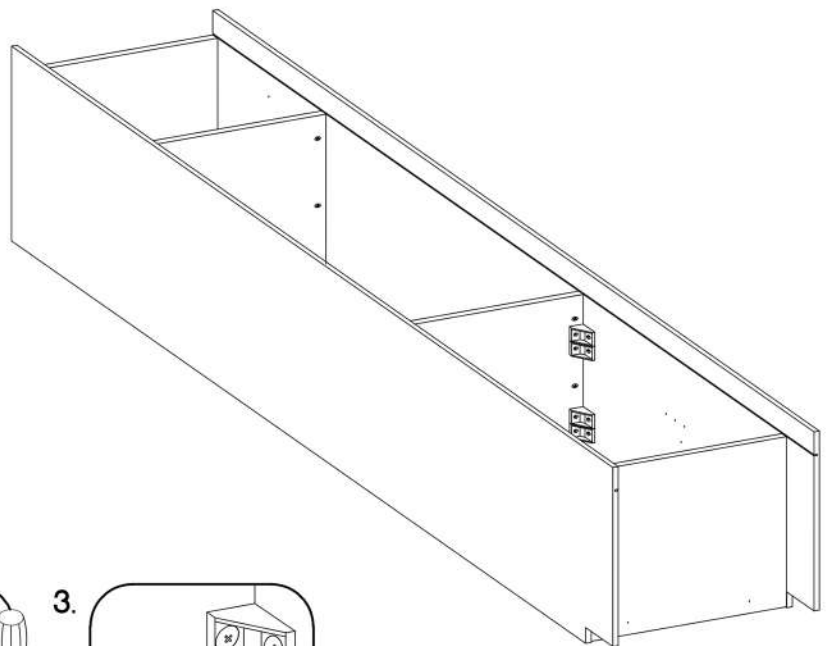
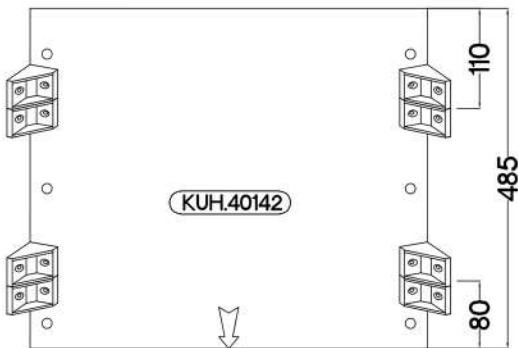

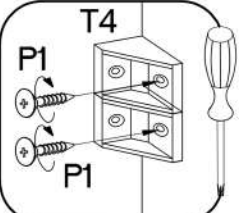
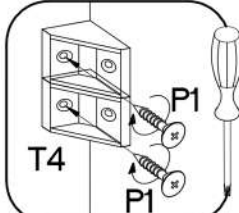
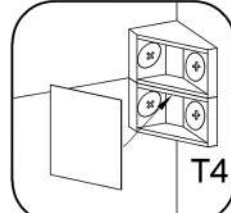
- 
- 
- 

15

φ3.0x20mm



P7

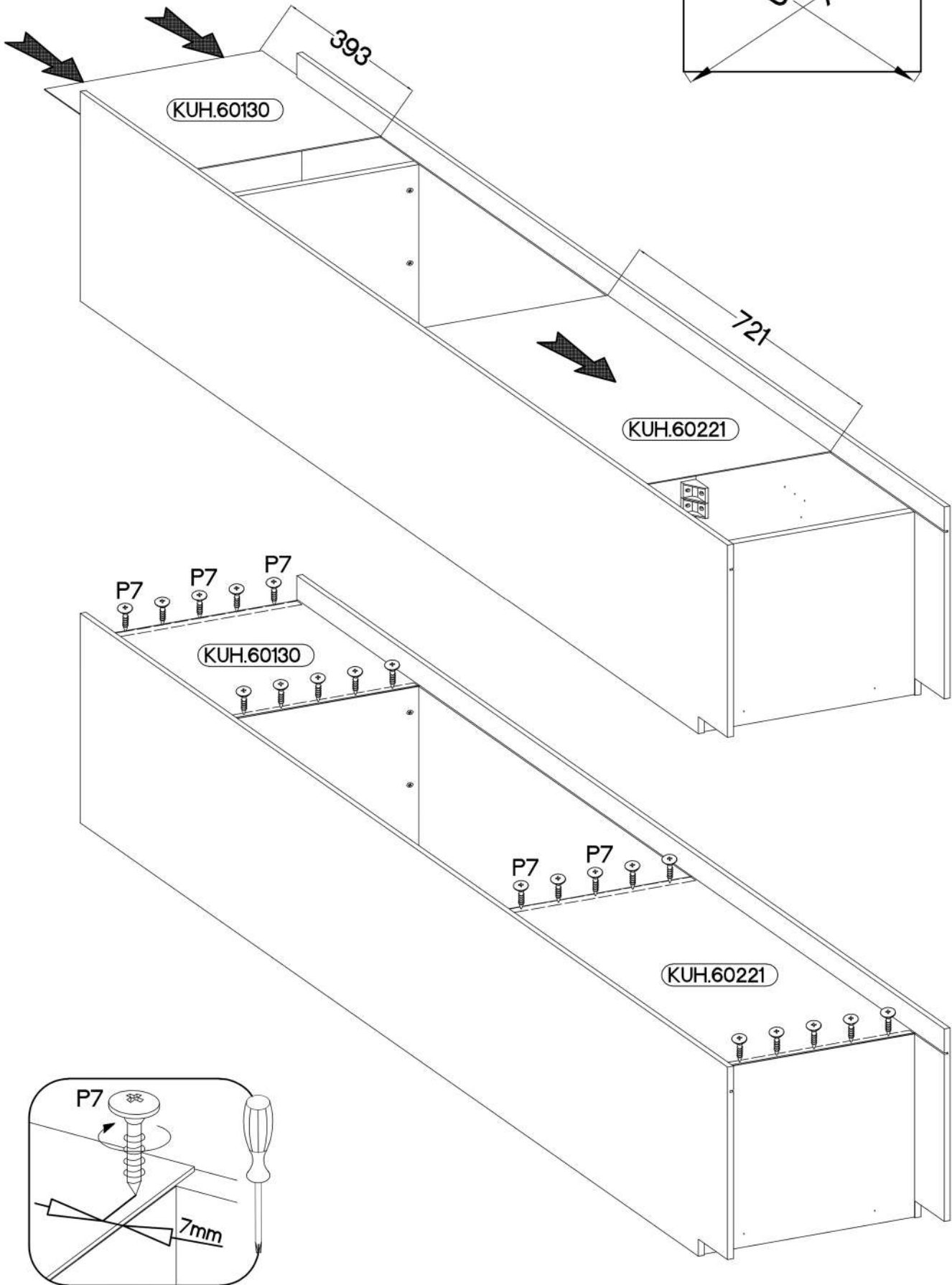
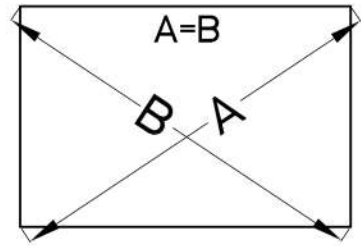

15-20

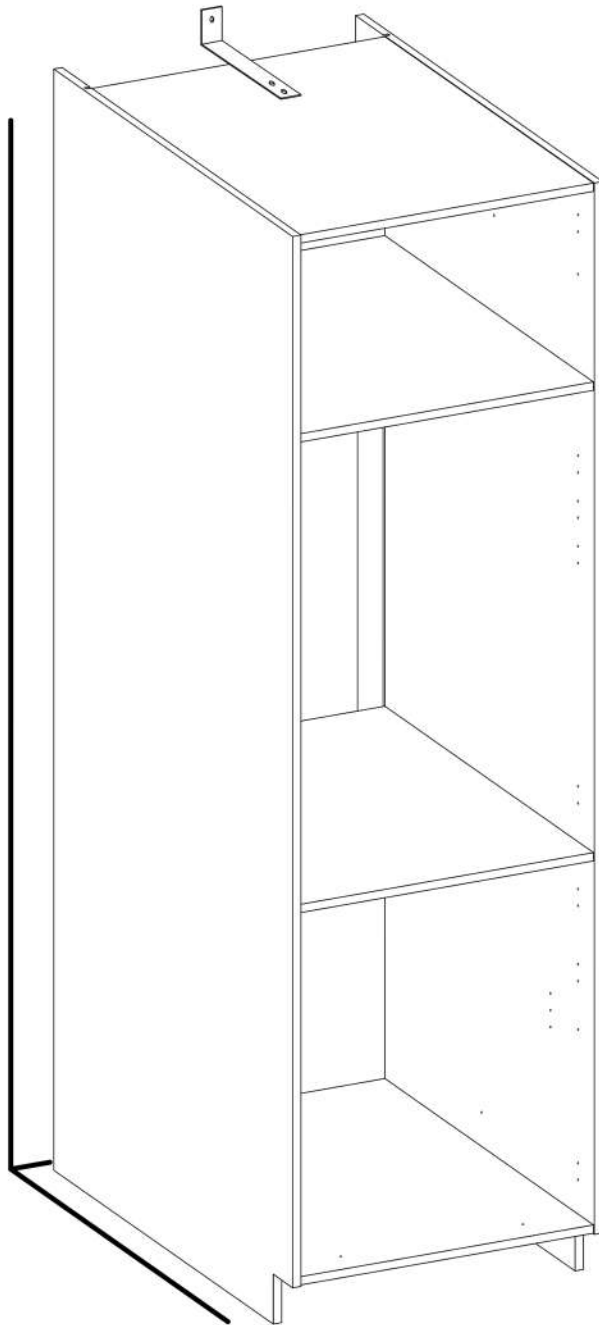
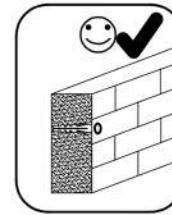
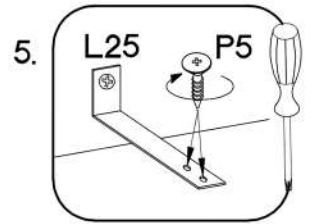
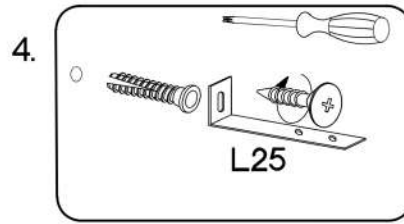
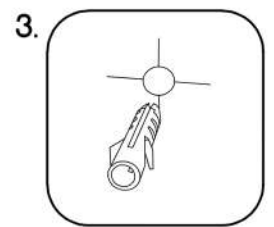
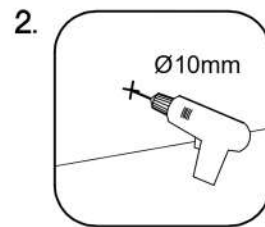
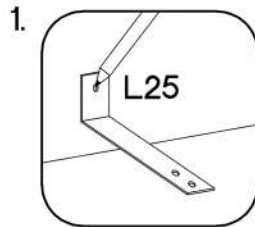
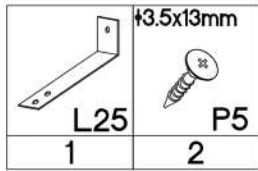

16



17

+4.0x45mm		
P4	E9	
2	2	

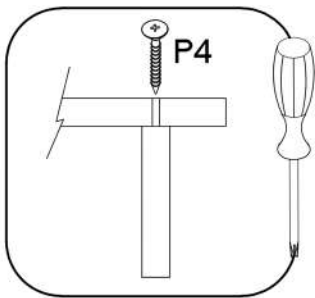
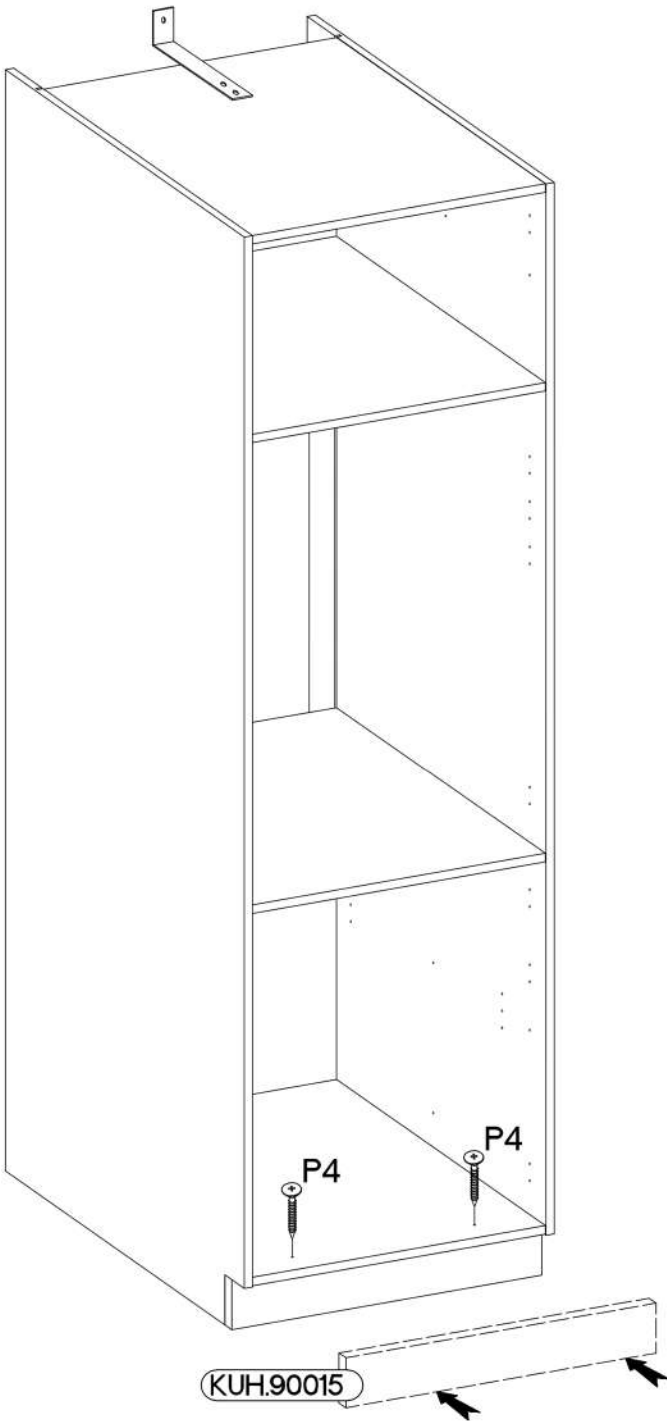

18

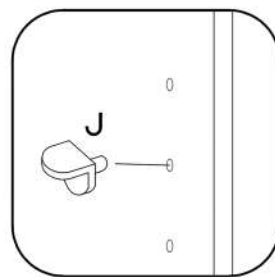
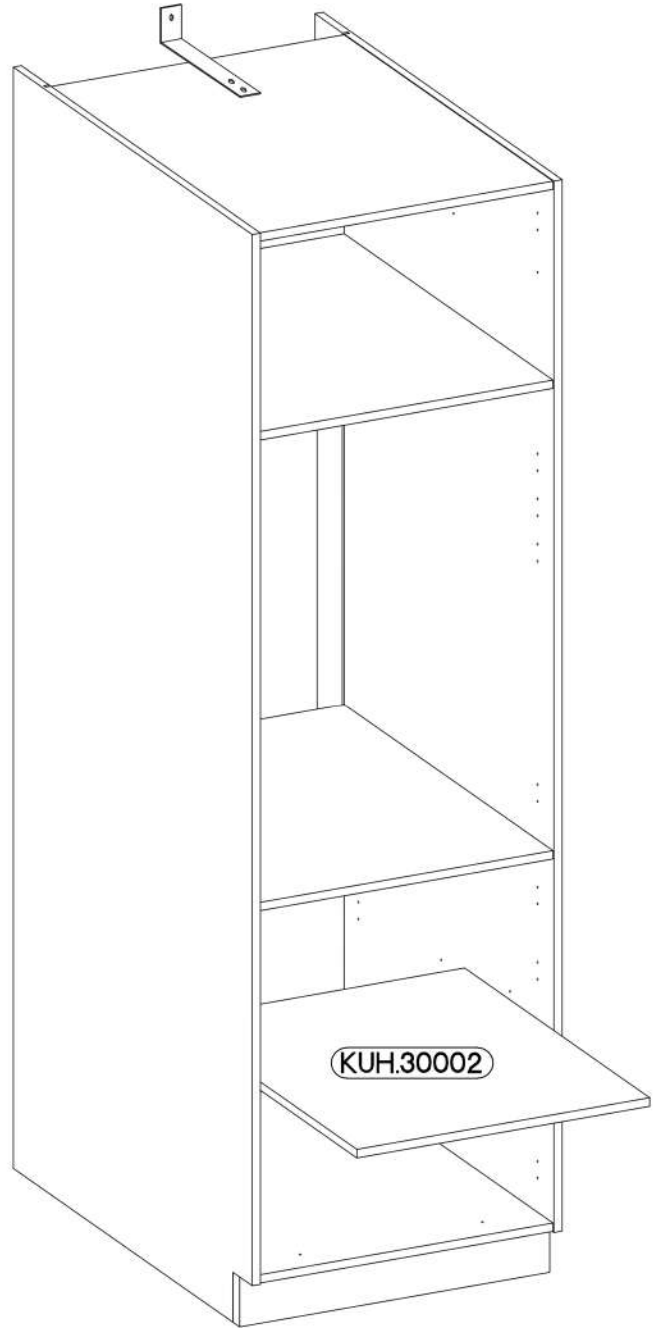

+5/19mm	
J	
4	

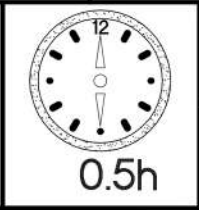
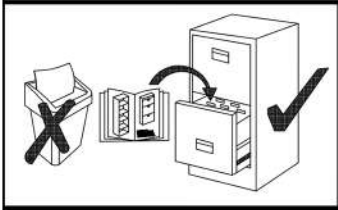
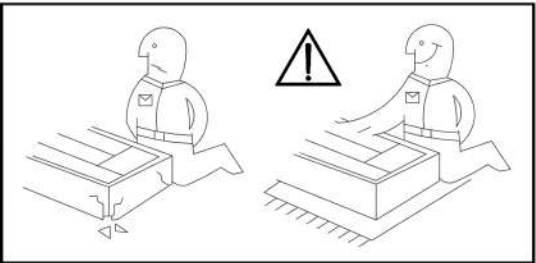
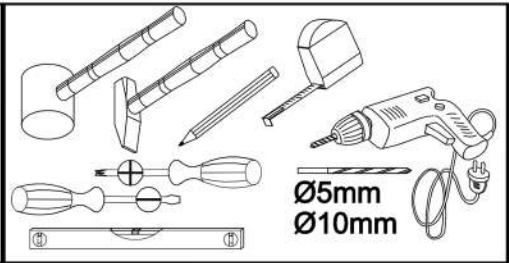
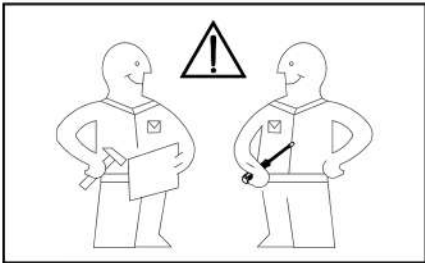

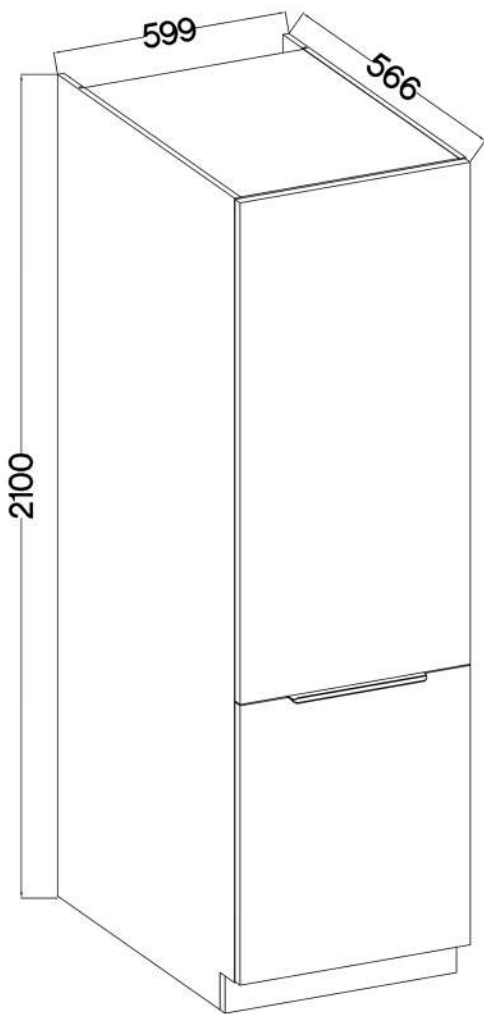
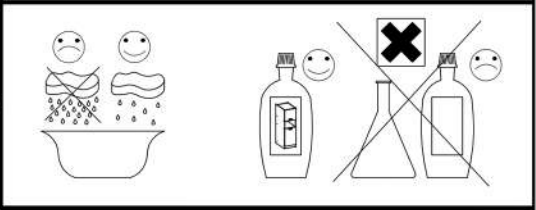

**60 LO-210-2F**



L=320mm	±7/2mm
	
S	J5
2	4

KUH.71173	1280x596x16
KUH.71151	713x596x16

# 1

$\pm 35/0\text{mm}$ [CD] HG 5	$\pm 3.5 \times 13\text{mm}$ P5 10	$\pm 7/2\text{mm}$ J5 4
--	--	-------------------------------

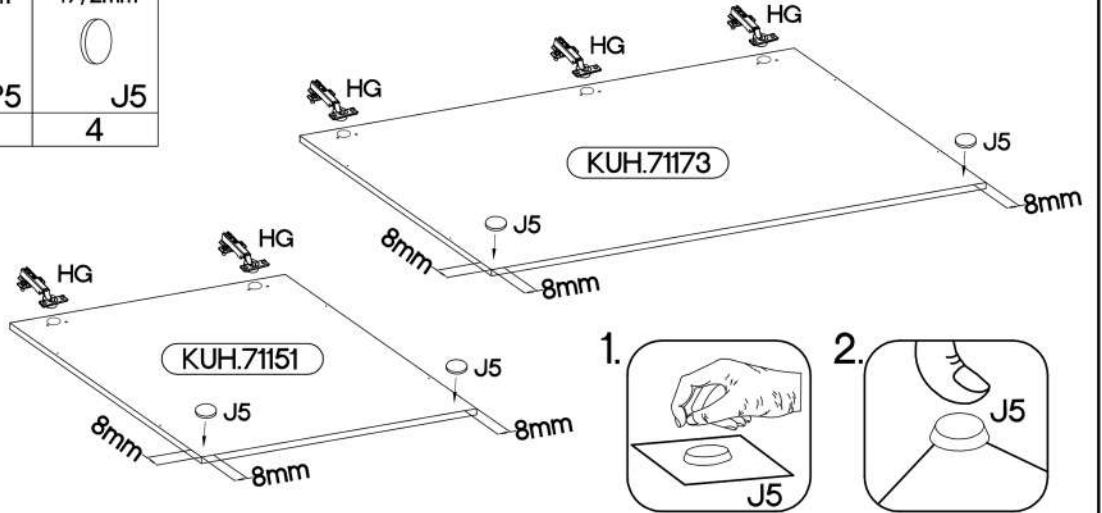
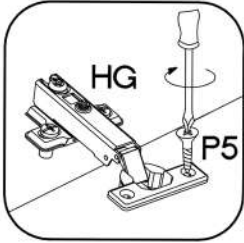

# 2

## 60 DK-2100 2F

L=320mm S 2
-------------------

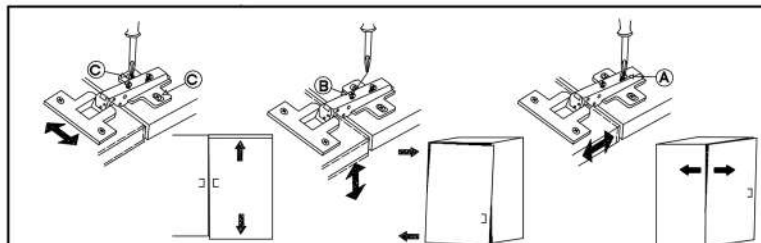
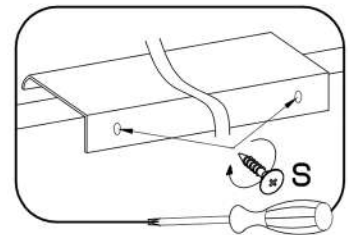
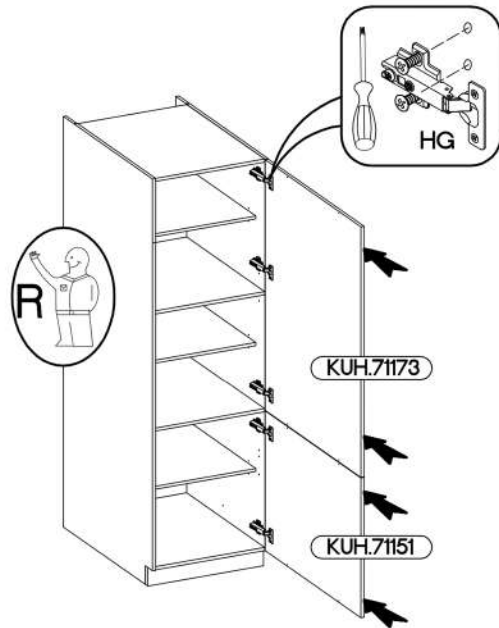
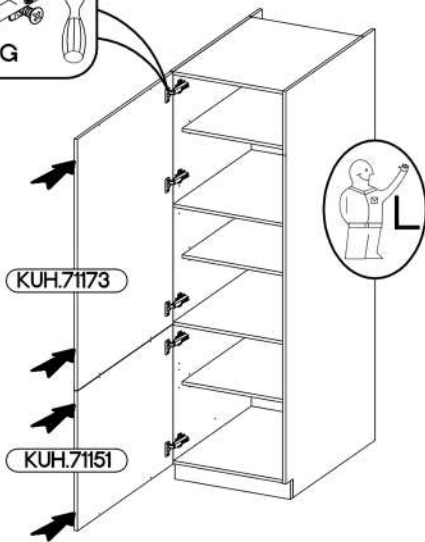

# 3

# 60 LO-2100

L=320mm

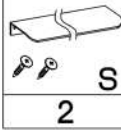

## WARIANT A

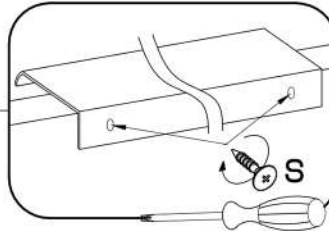
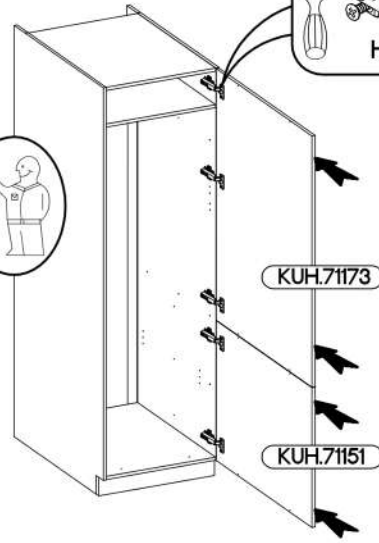
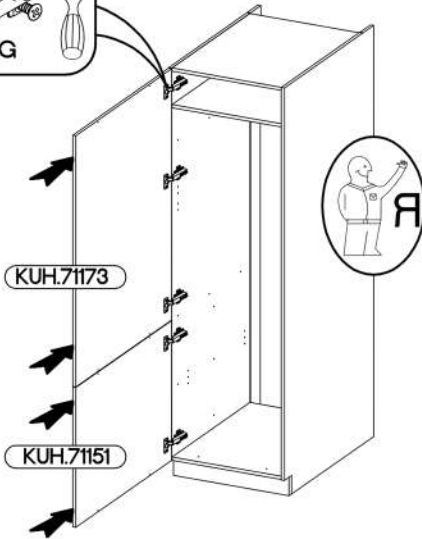

## WARIANT B

