

# ARSANY 30 G-108 1F

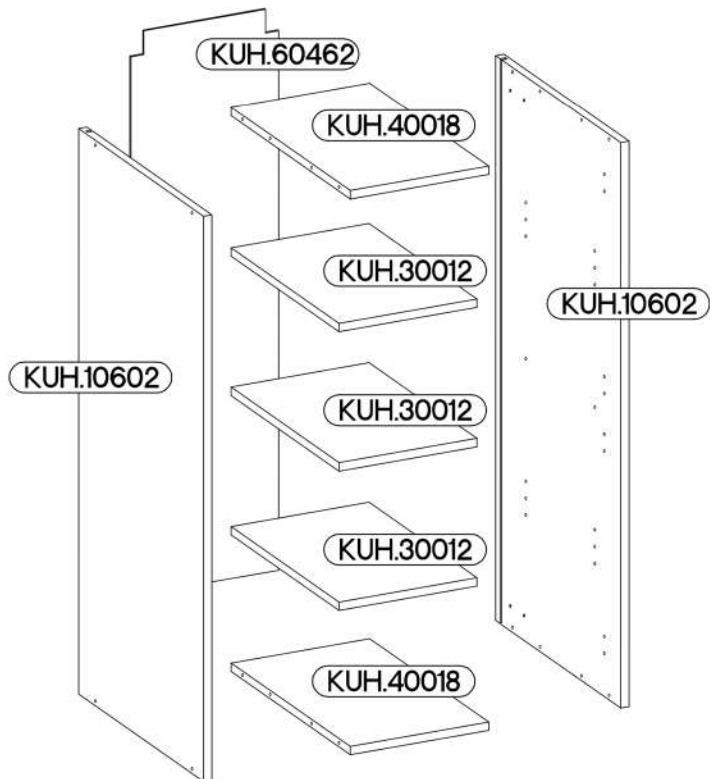

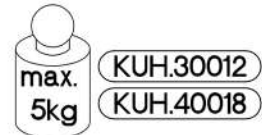
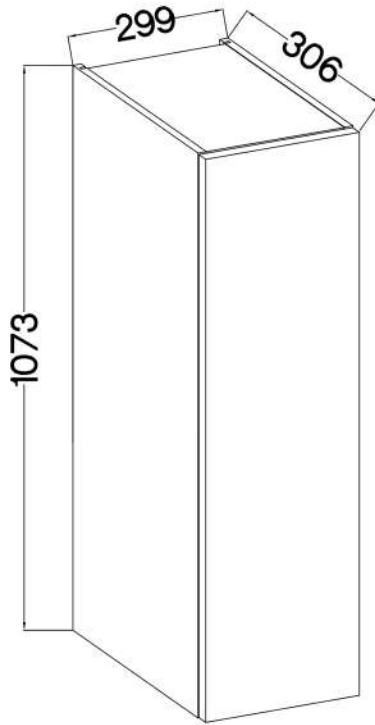
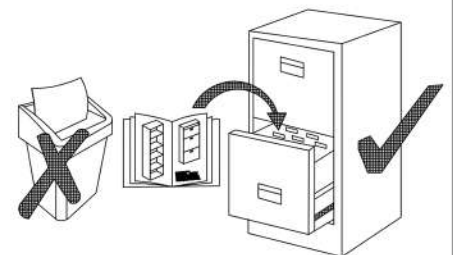

KUH.10602 x2	1073x290x16
KUH.30012 x3	266x250x16
KUH.40018 x2	267x276x16
KUH.60462	1070x285x2,5

 A 8	 B 8	 E1 8	 HG 3	 P5 6	 P7 8-10	 P8 4
 J3 12	 K 2	 O 1	 P5 6	 P7 8-10	 P8 4	



1

 ‡8x30mm A	 ‡4.0x30mm P8	 K
8	4	2

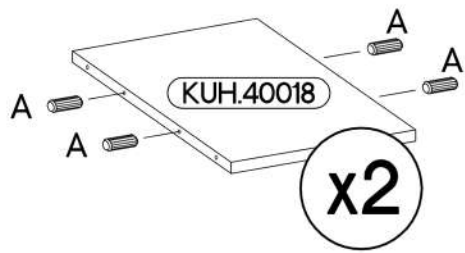
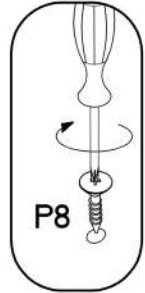
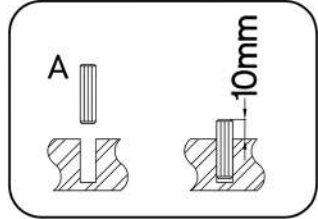
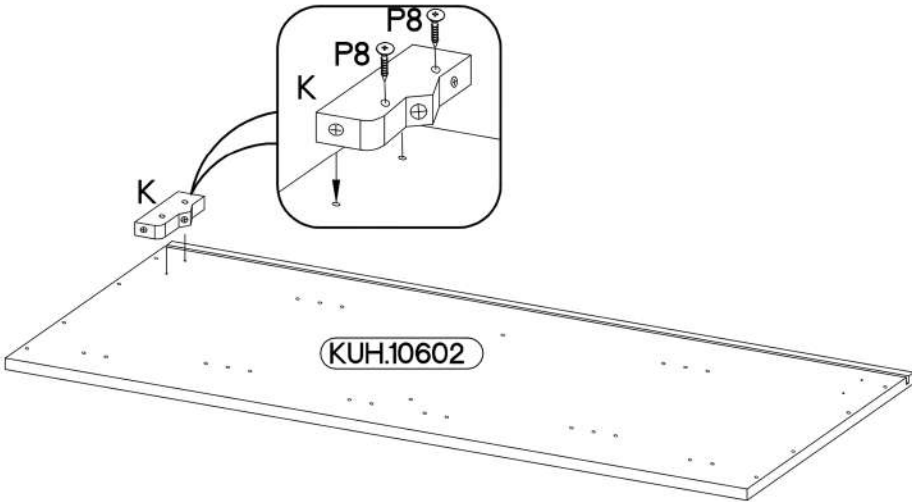
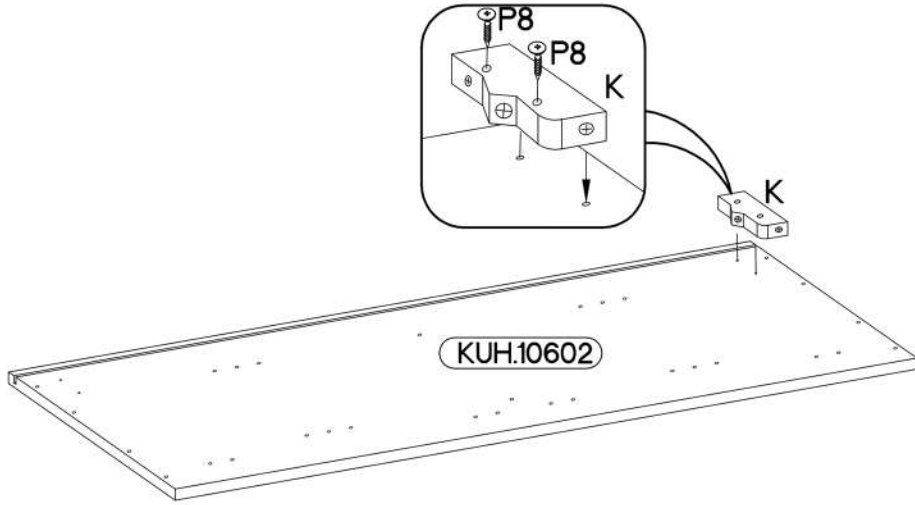
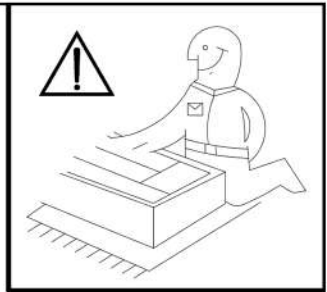

2

6,4 x 50mm

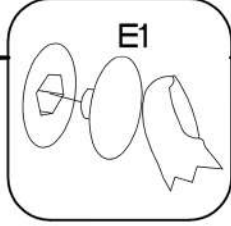
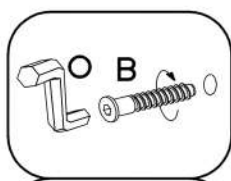
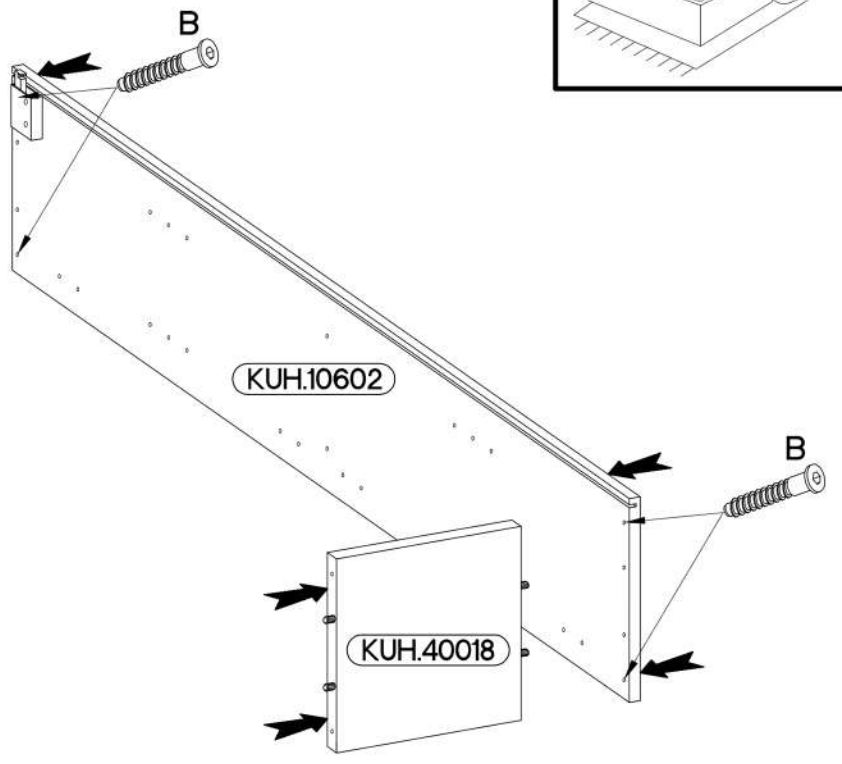
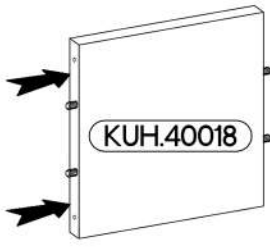
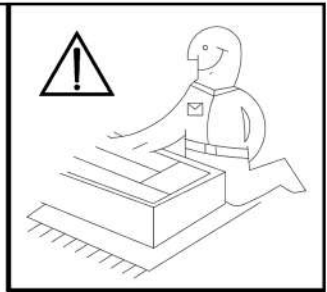
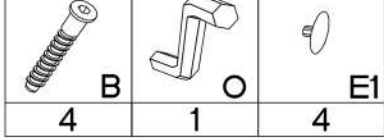

3

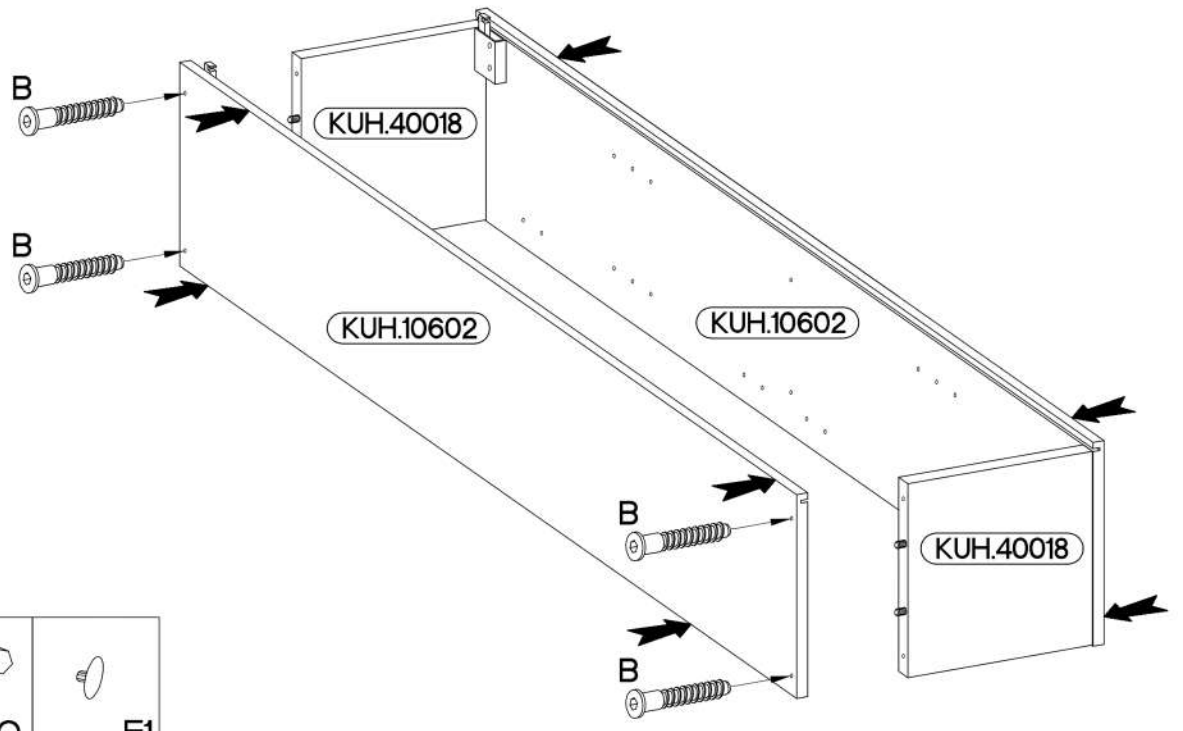

6,4 x 50mm

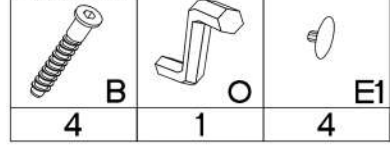

4

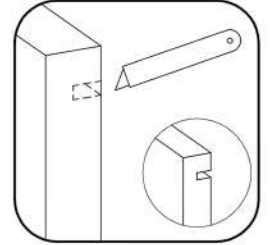
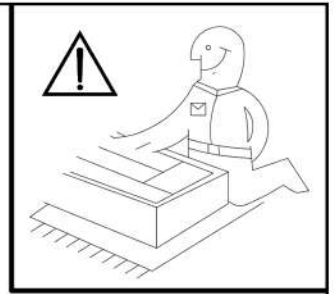
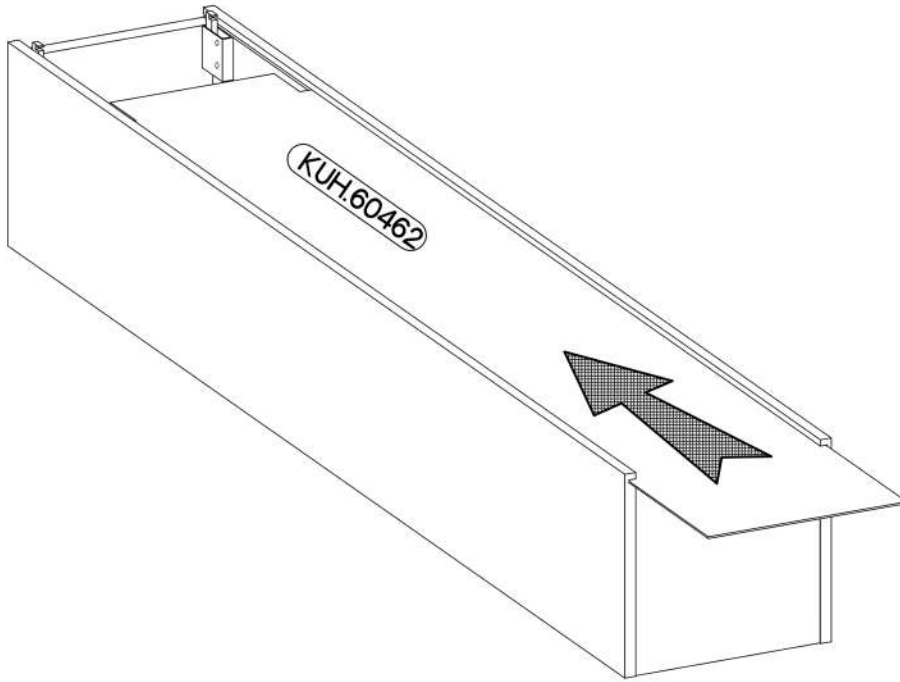

5

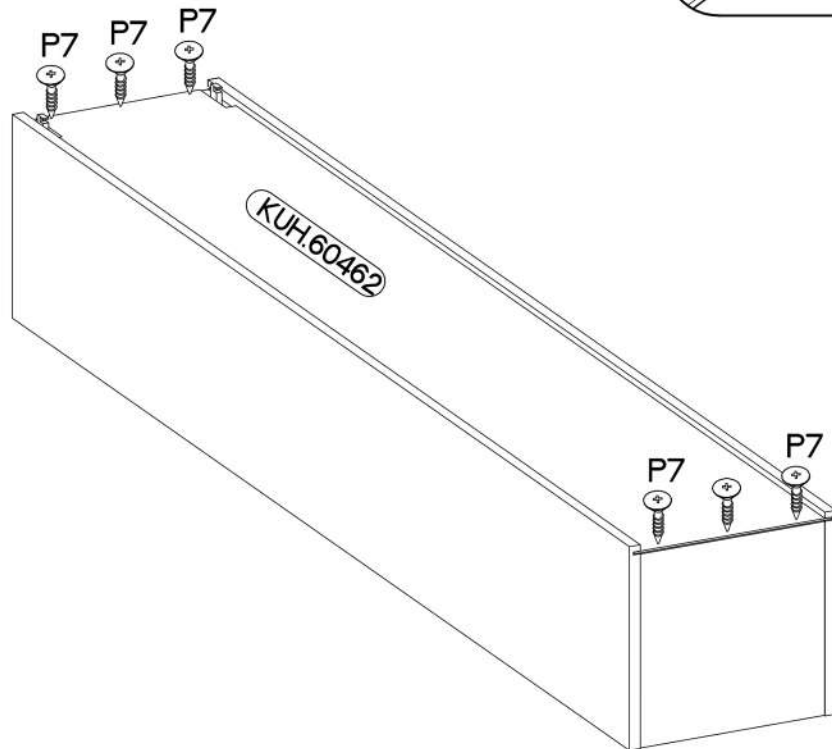
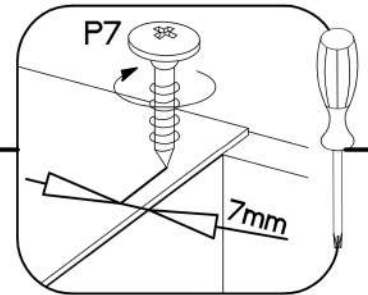
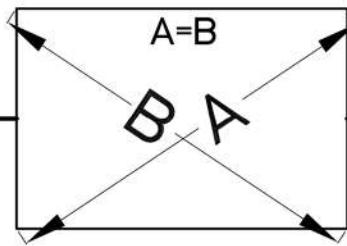

6

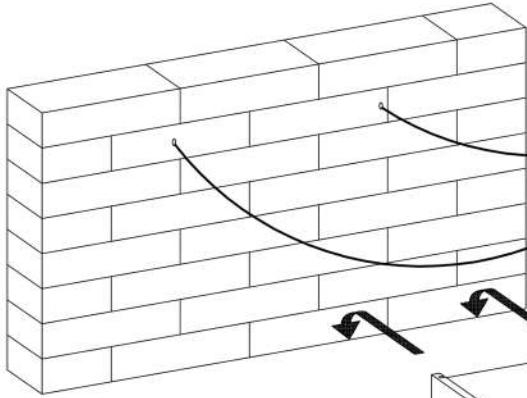
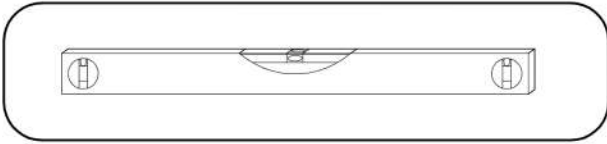

A

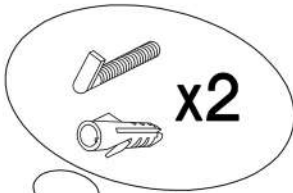
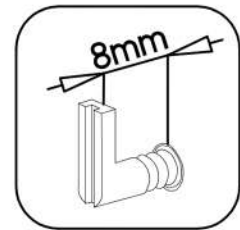
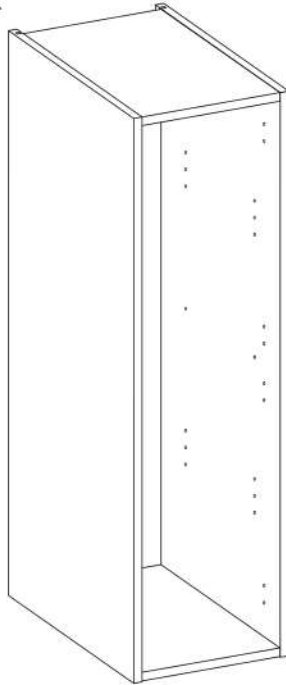
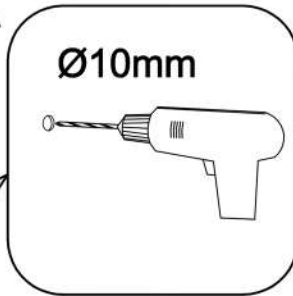

C

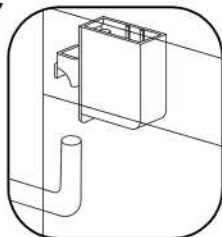

D

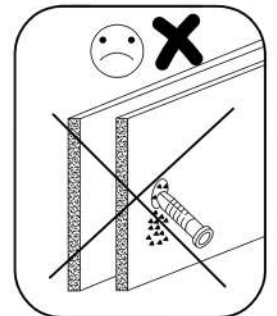
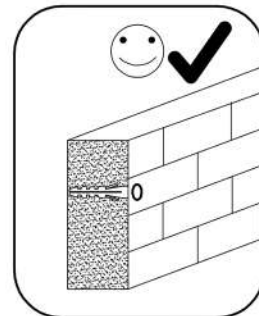
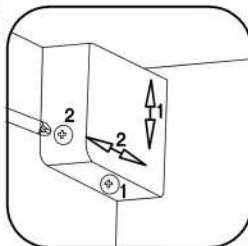

7

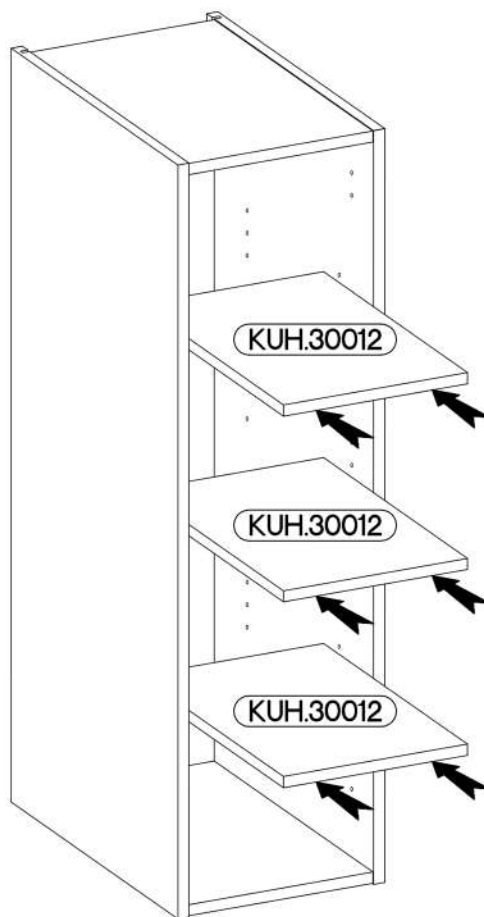
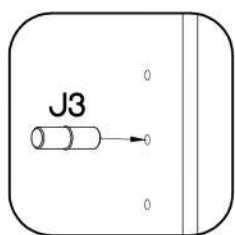
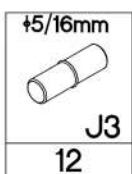

8

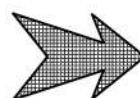
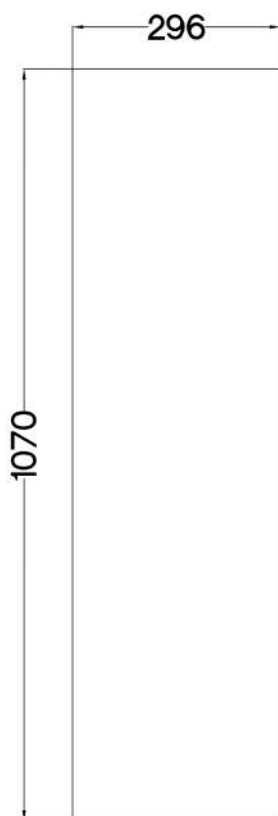

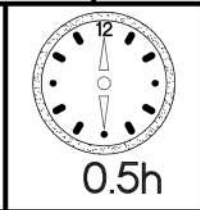
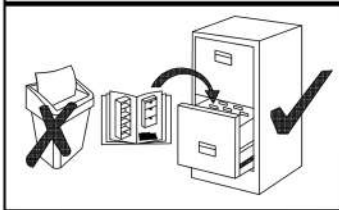
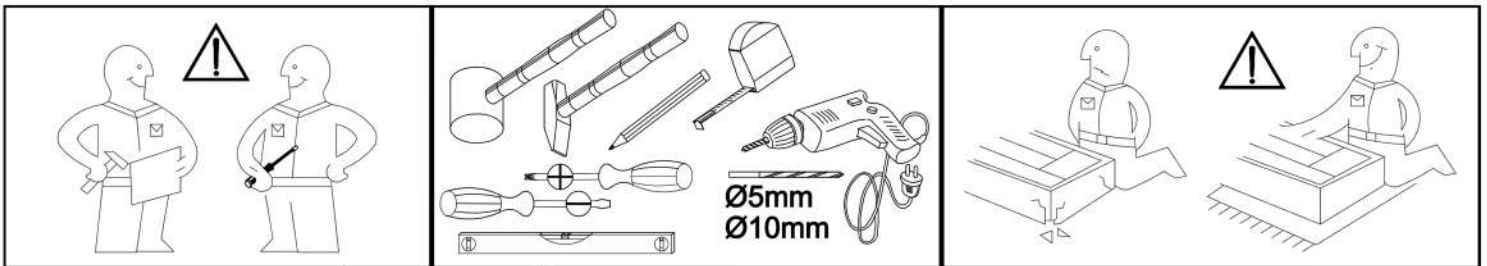

**1070X296**

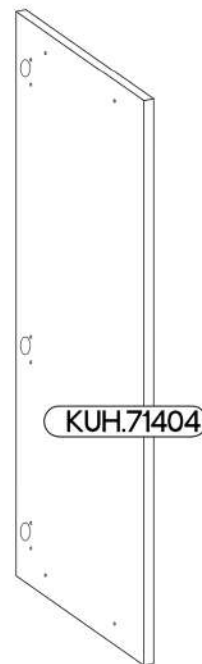
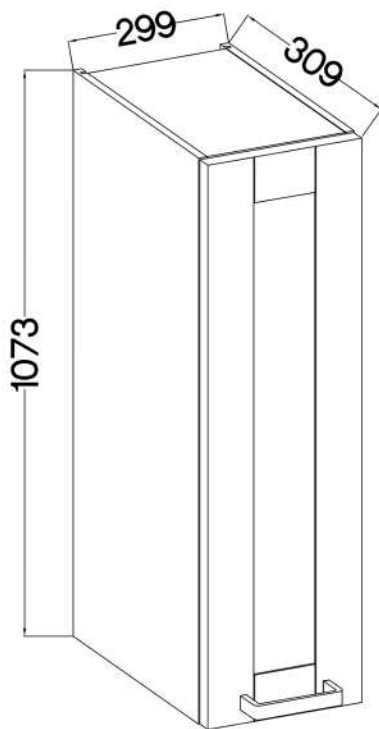

L=160mm	M4x27mm
S	U8
1	2

KUH.71404	1070x296x19
-----------	-------------



1

LEFT

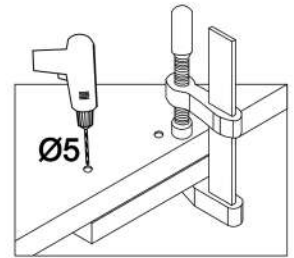
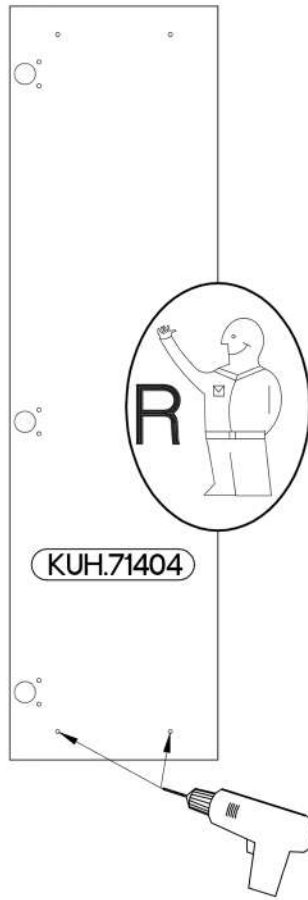
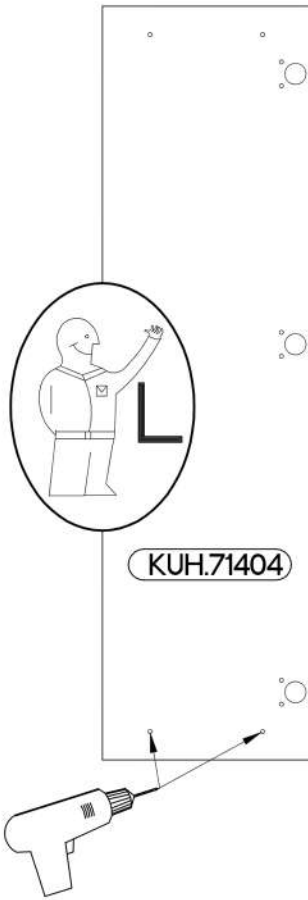
RIGHT



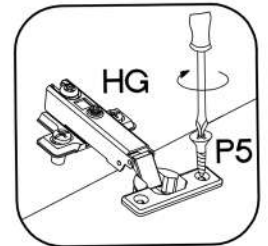
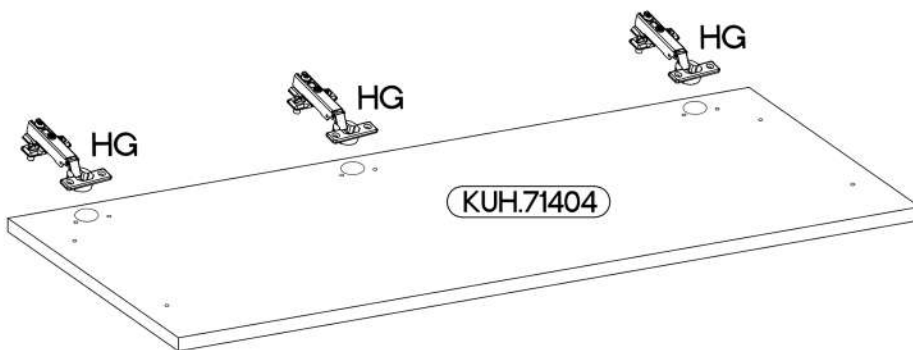

2

$\varnothing 35/0\text{mm}$	$\varnothing 3.5 \times 13\text{mm}$
	
HG	P5
3	6



3

L=160mm	M4x27mm
	
S	U8
1	2

