

ARSANY 30 G 90 1F

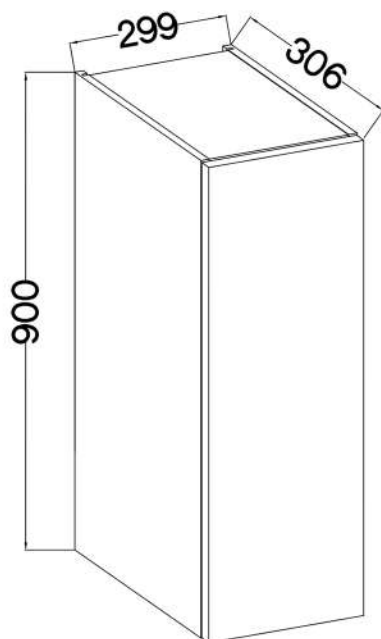

KUH.30012
KUH.40018

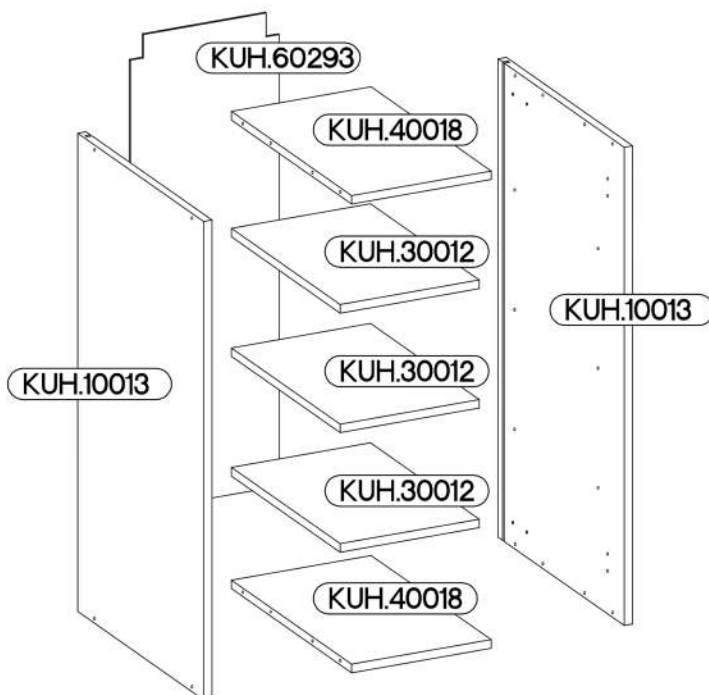

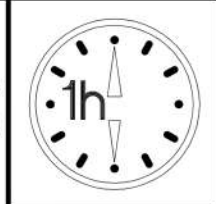

KUH.10013 x2	900x290x16
KUH.30012 x3	266x250x16
KUH.40018 x2	267x276x16
KUH.60293	896x285x2,5

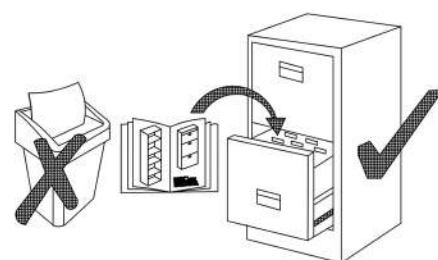
 +8x30mm A 8	 6,4 x 50mm B 8	 E1 8	 +35/0mm HG 2	 +3.5x13mm P5 4	 +3.0x20mm P7 8-10	 +4.0x30mm P8 4
 J 12	 K 2	 O 1				



1

 +8x30mm A	 +4.0x30mm P8	 K
8	4	2

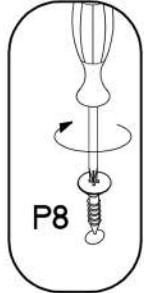
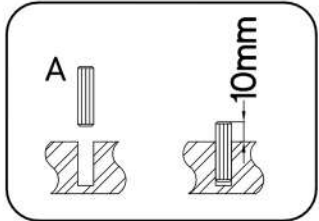
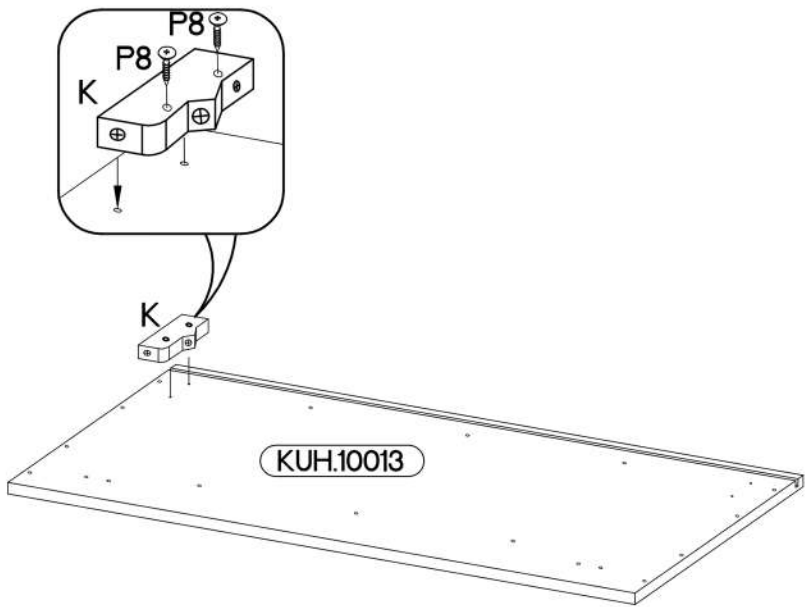
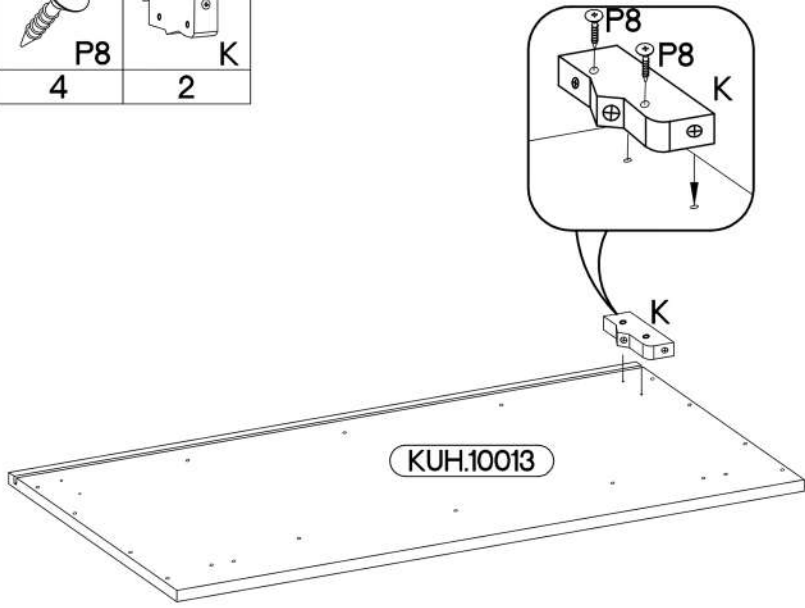
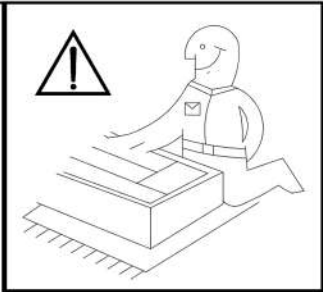

2

6,4 x 50mm

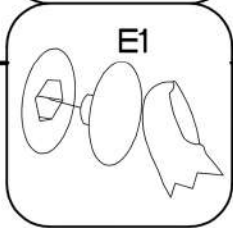
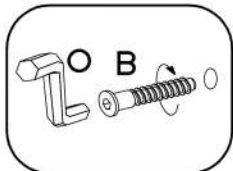
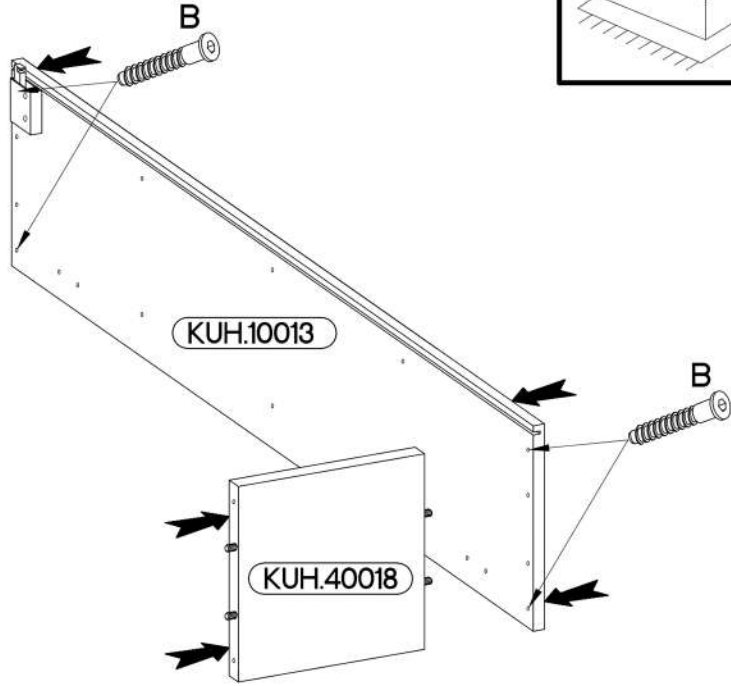
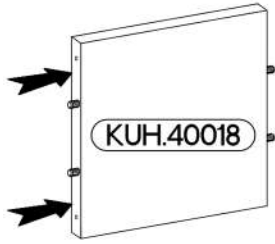
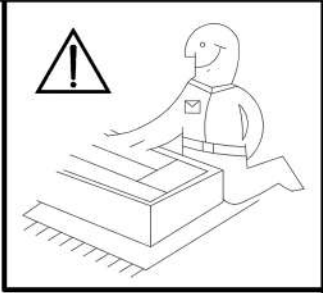
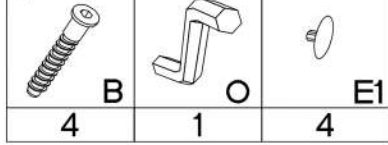

3

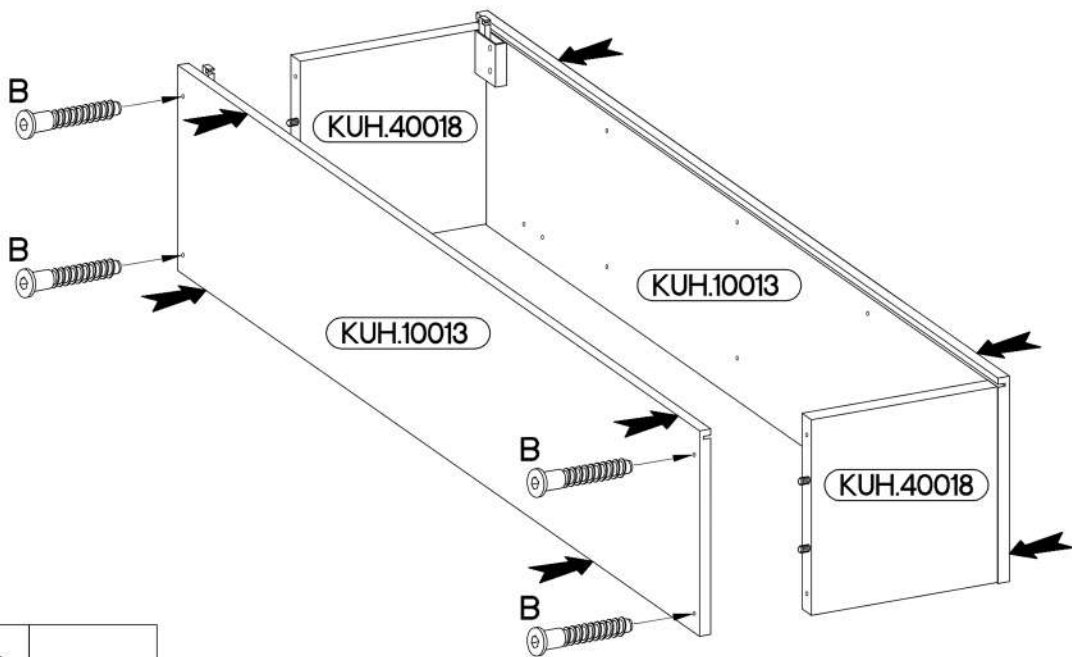

6,4 x 50mm

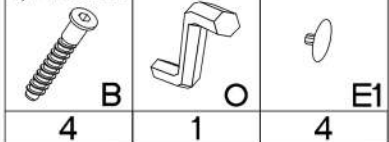

4

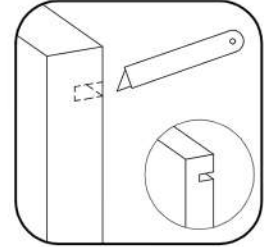
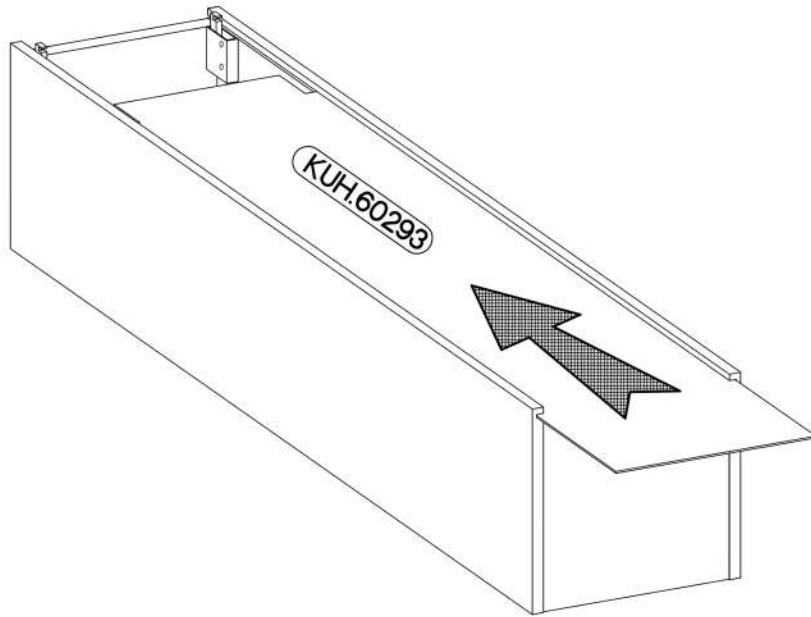
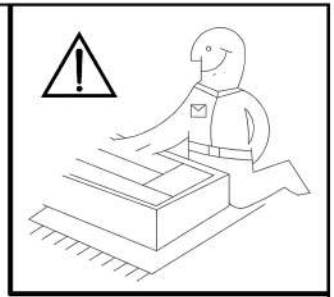

5

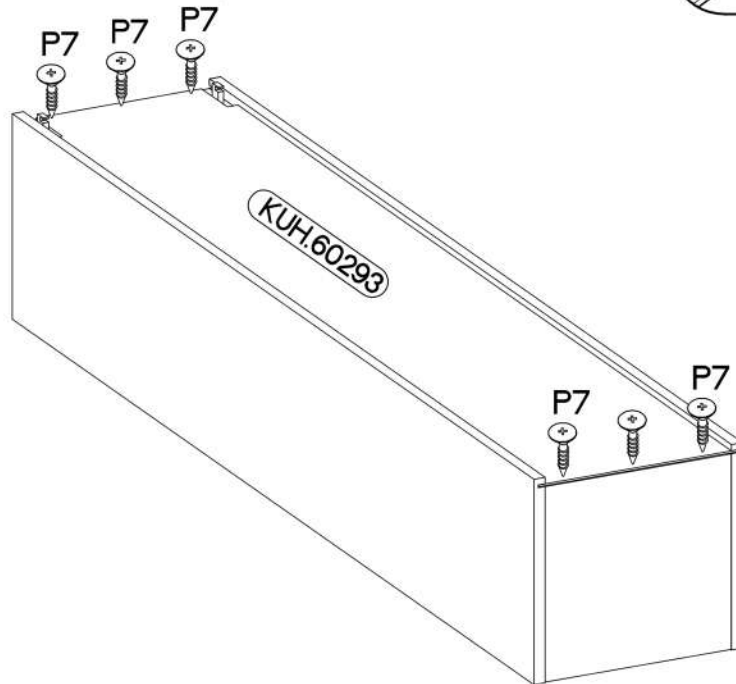
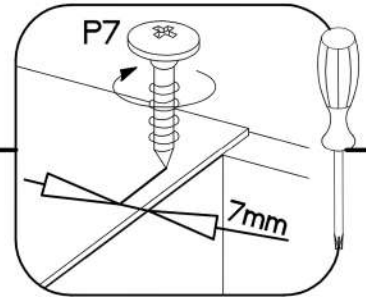
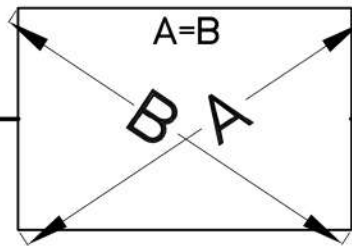

6

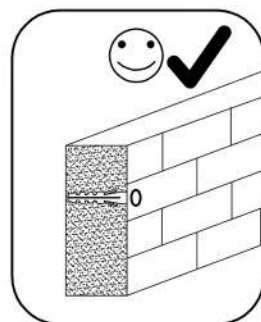
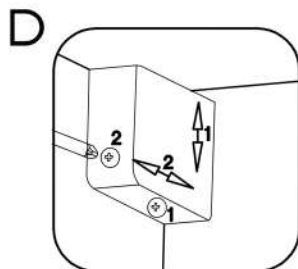
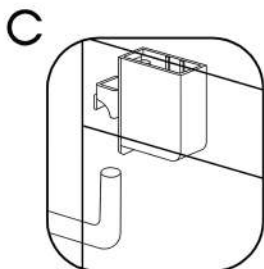
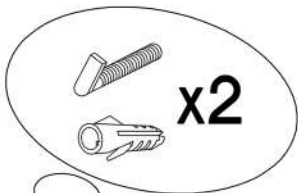
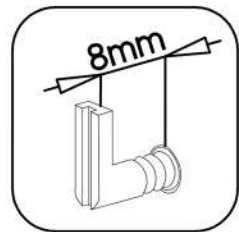
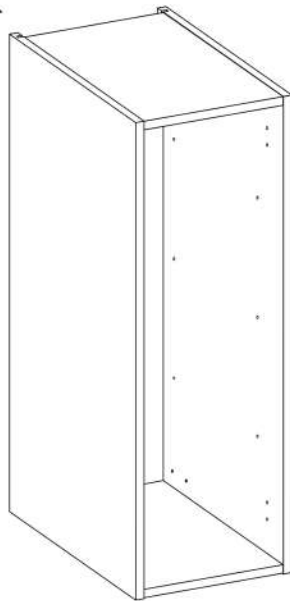
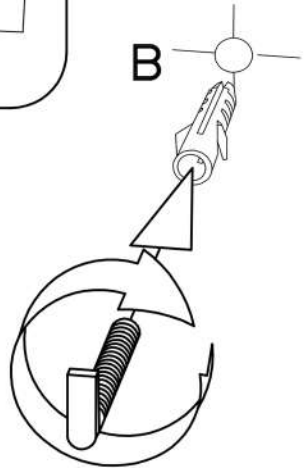
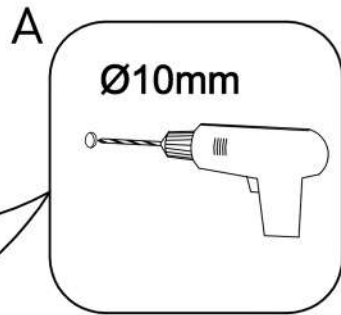
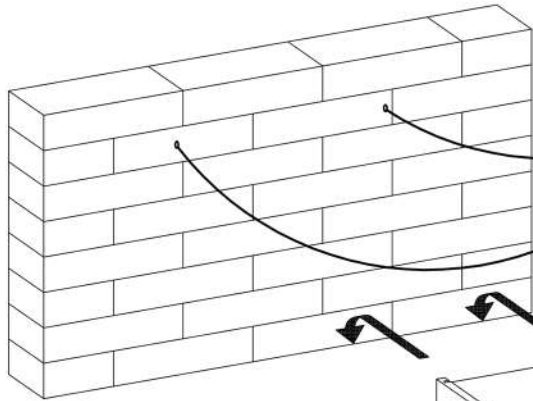
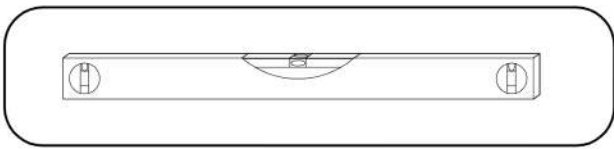

7

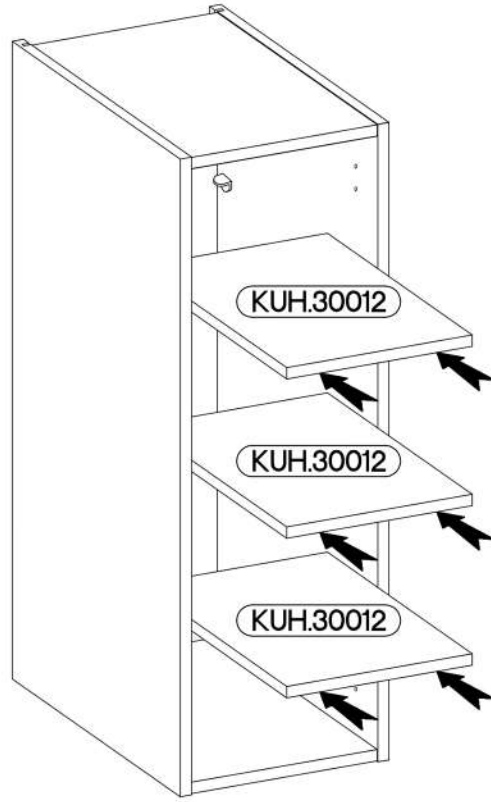
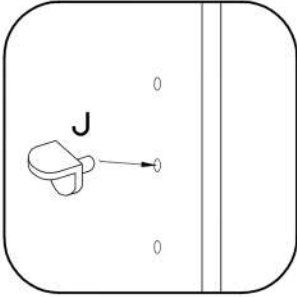
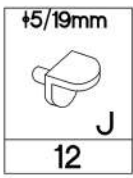

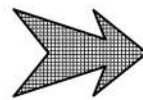
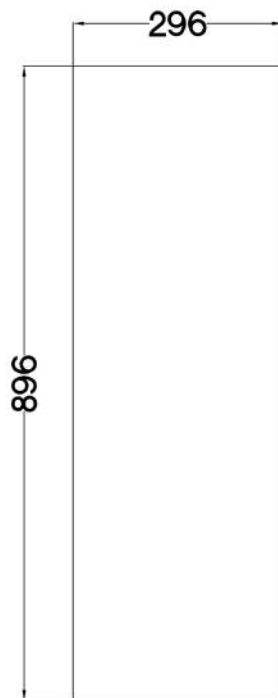

8

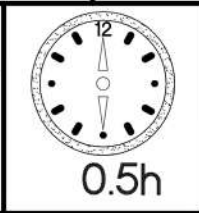
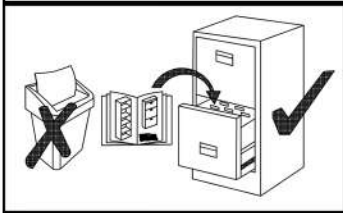
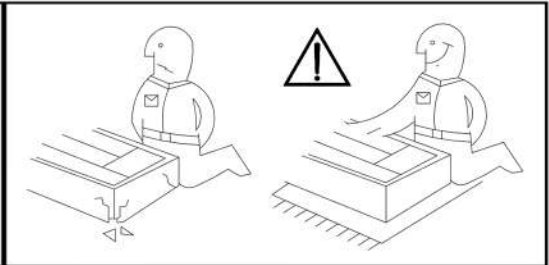
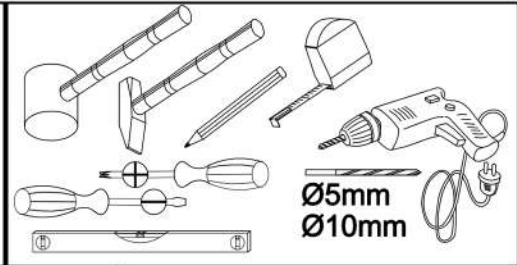
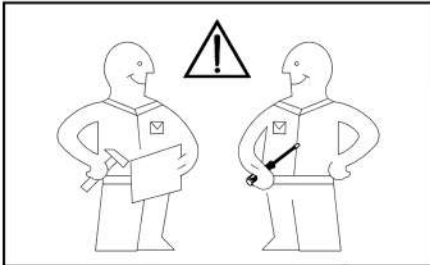



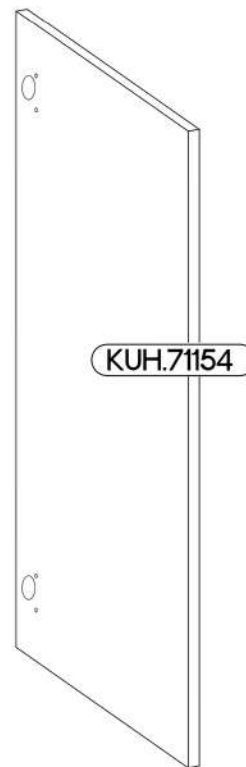
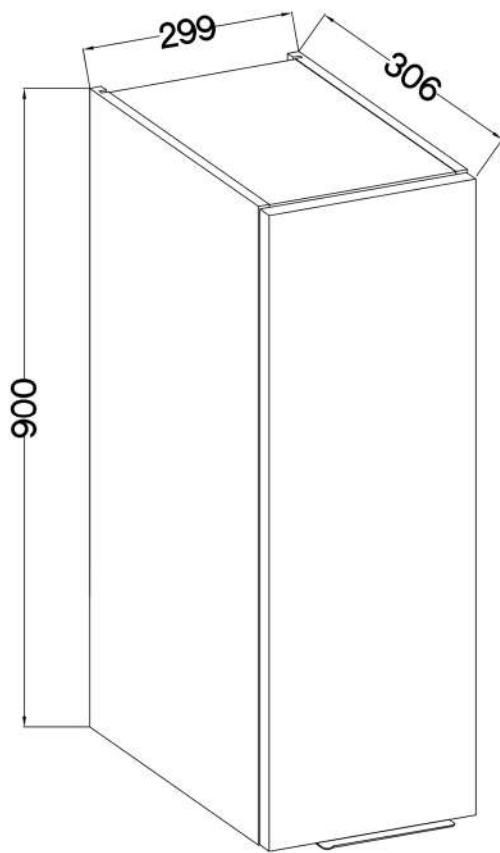
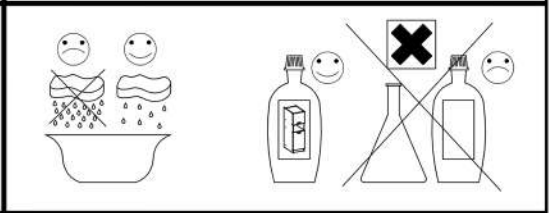

896x296



L=160mm	±7/2mm
	
S	J5
1	2

KUH.71154	896x296x16
-----------	------------

2

$\pm 35/0\text{mm}$  [CD] HG 2	$\pm 3.5 \times 13\text{mm}$  P5 4	$\pm 7/2\text{mm}$  J5 2
--	--	--

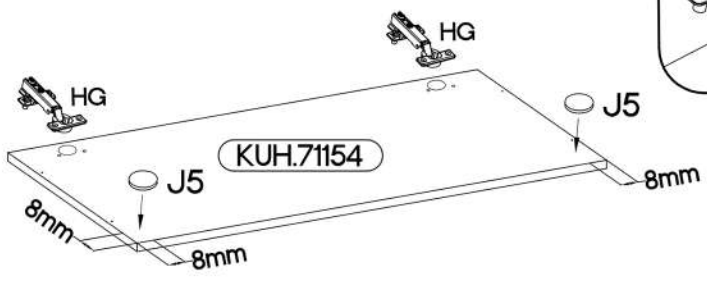
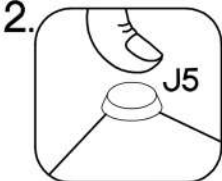
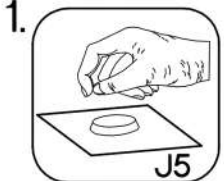
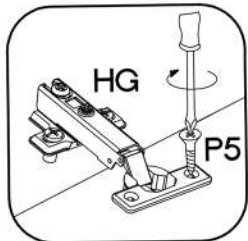

3

$L=160\text{mm}$  S 1

