

ARSANY 30 G-72 1F

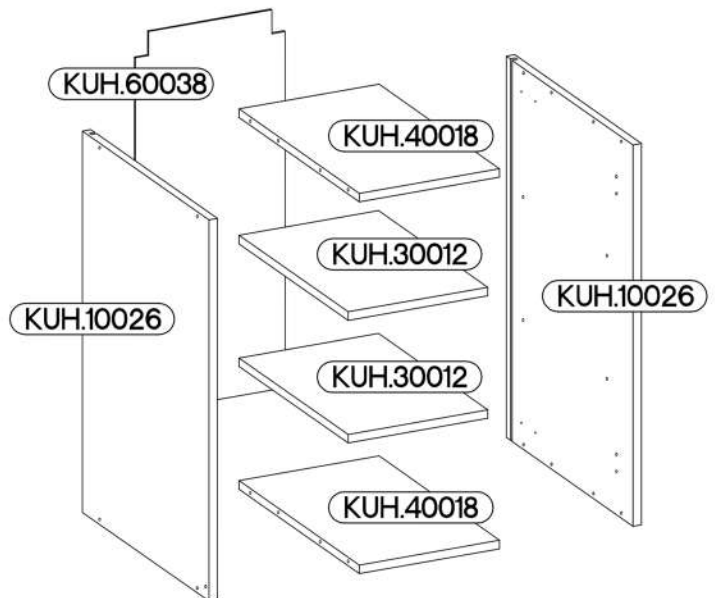

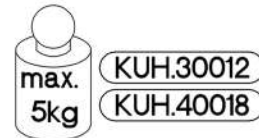
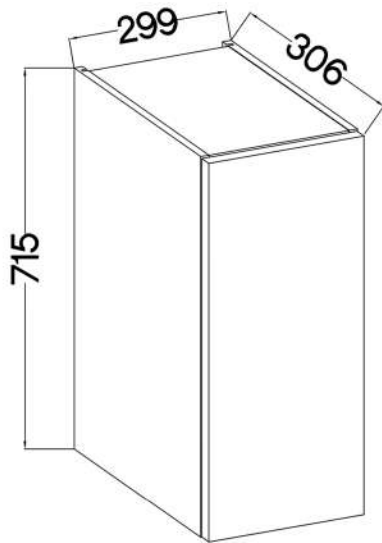
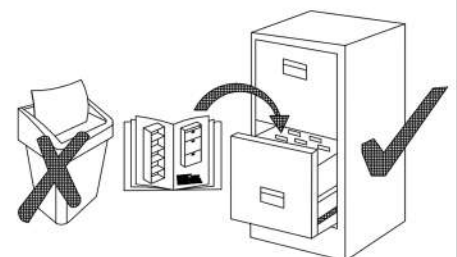

KUH.10026 x2	715x290x16
KUH.30012 x2	266x250x16
KUH.40018 x2	267x276x16
KUH.60038	713x285x2,5

A 8	B 8	E1 8	HG 2	J 8	K 2	O 1	P5 4	P7 8-10	P8 4
--------	--------	---------	---------	--------	--------	--------	---------	------------	---------



1

 +8x30mm A	 +4.0x30mm P8	 K
8	4	2

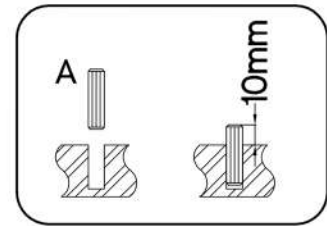
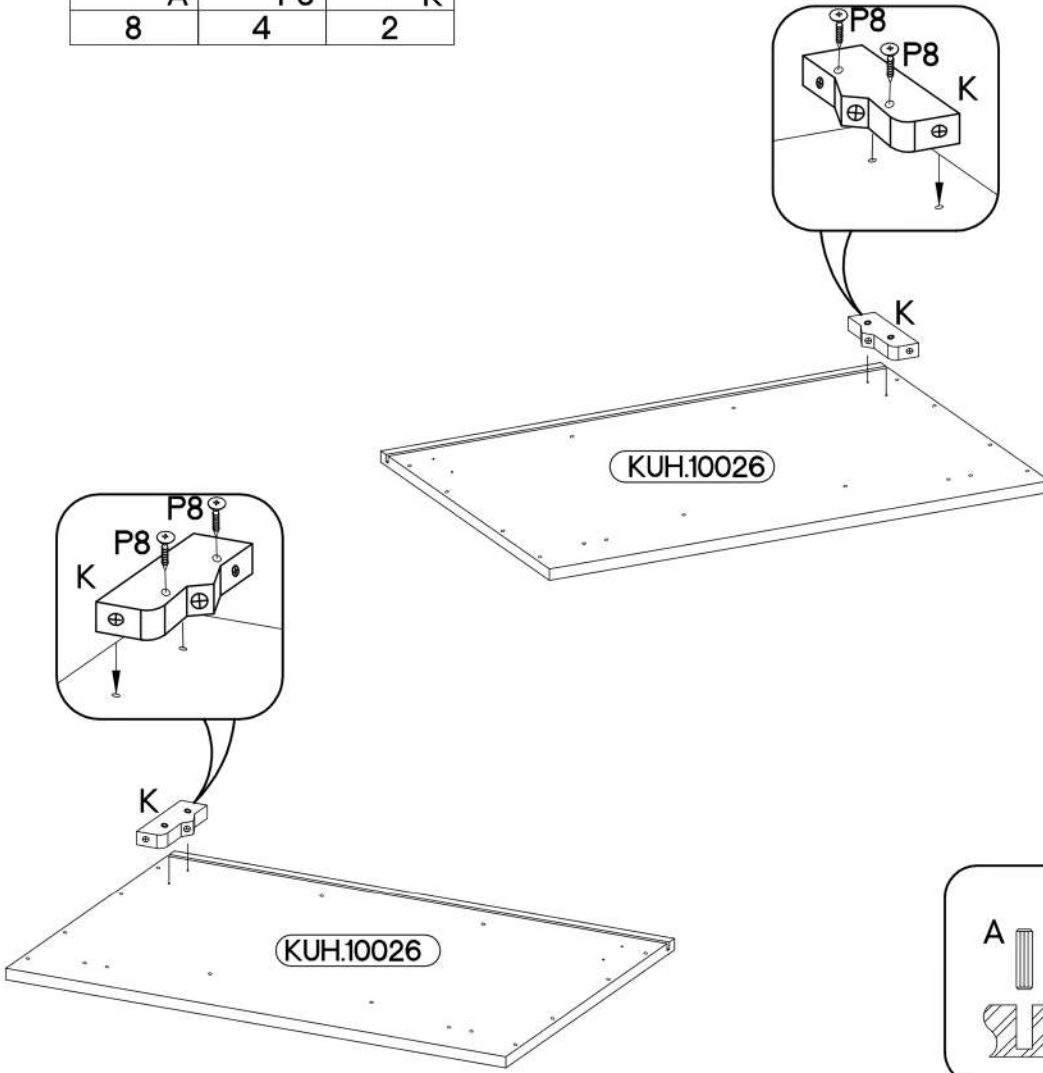

2

6,4 x 50mm

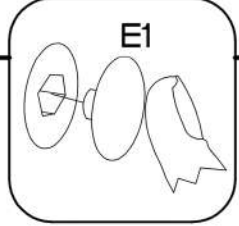
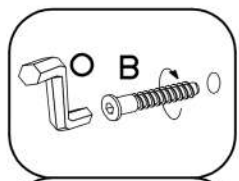
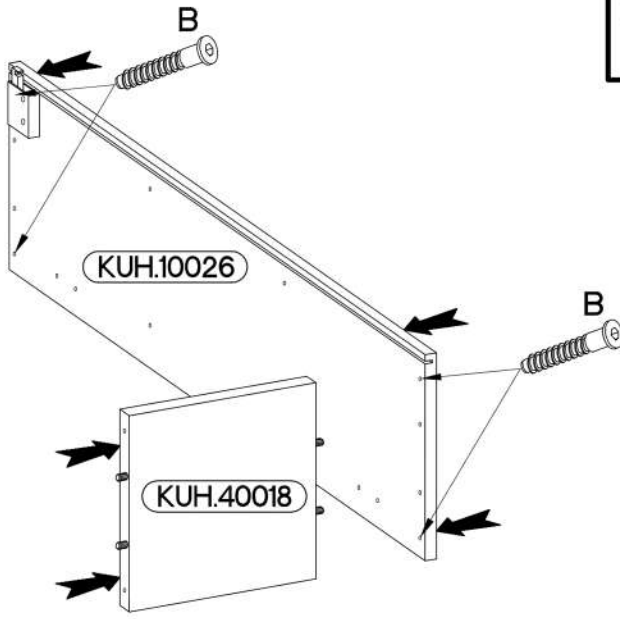
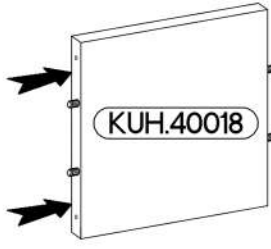
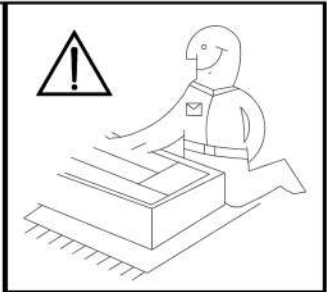
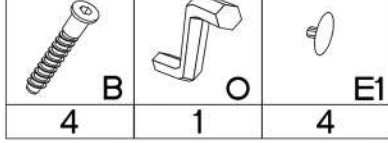

3

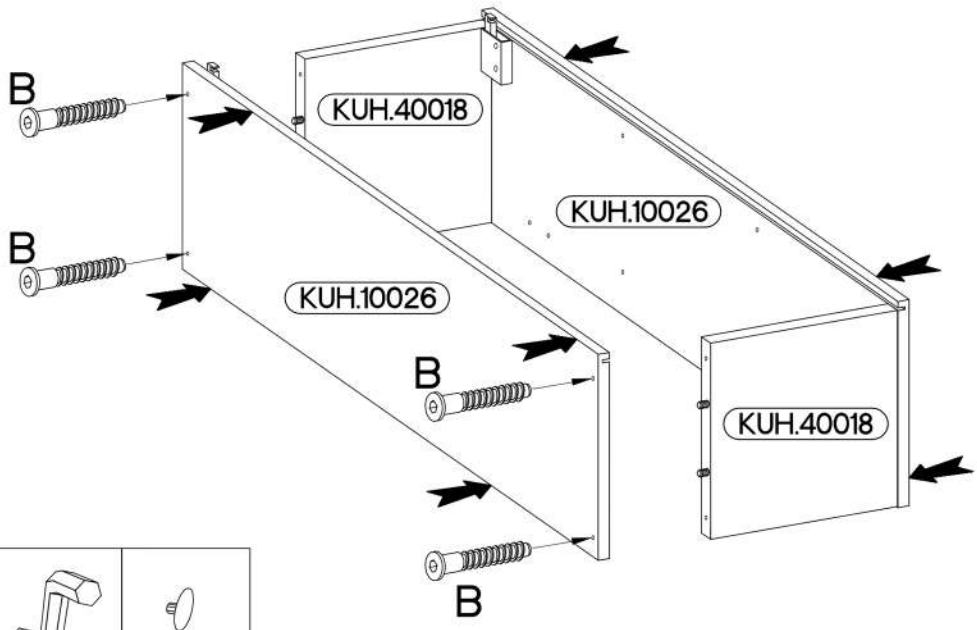

6,4 x 50mm

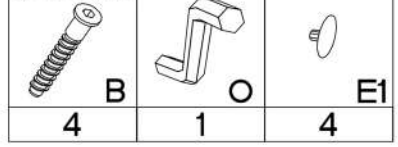

4

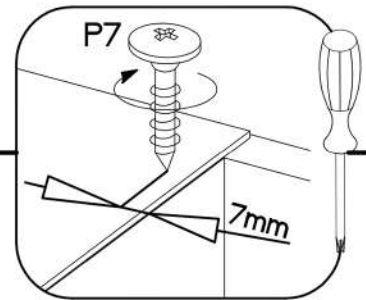
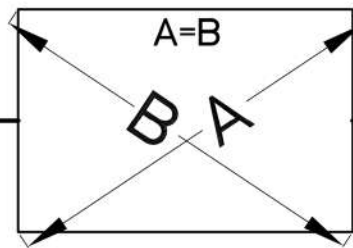
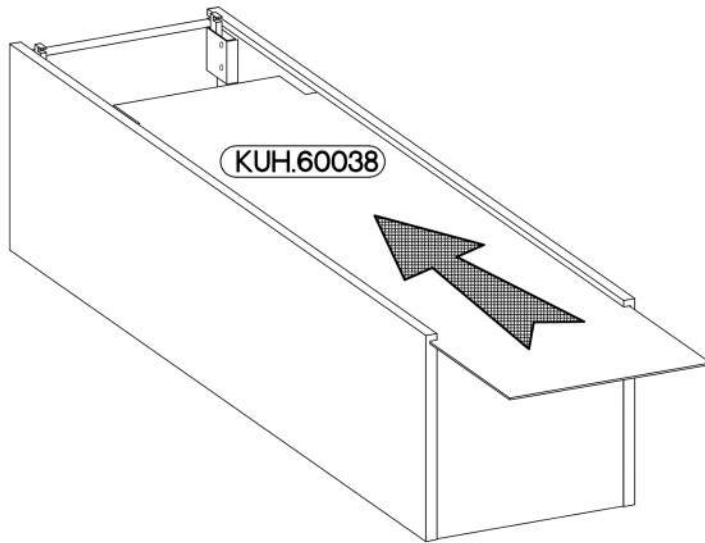
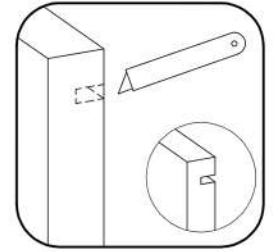

5

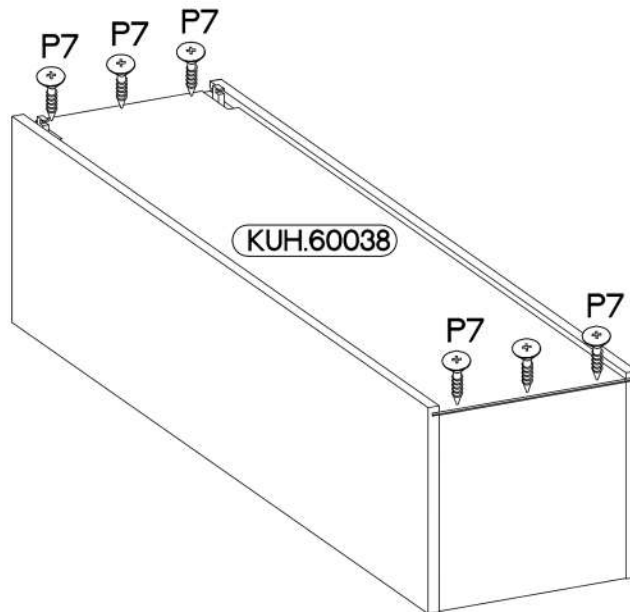

6

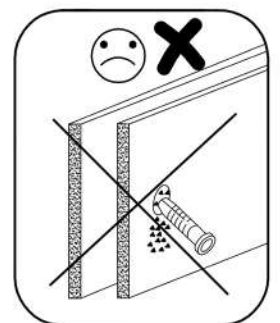
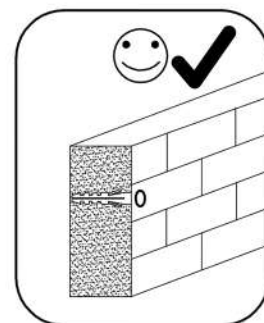
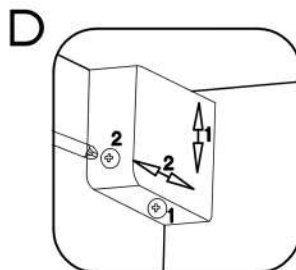
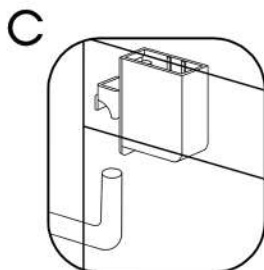
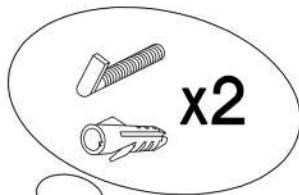
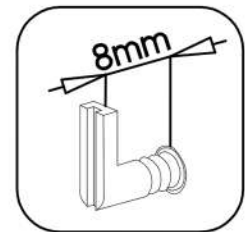
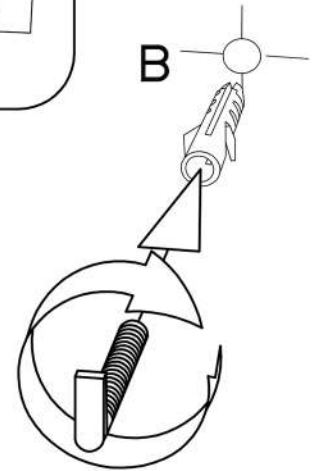
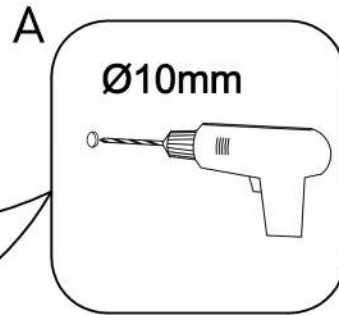
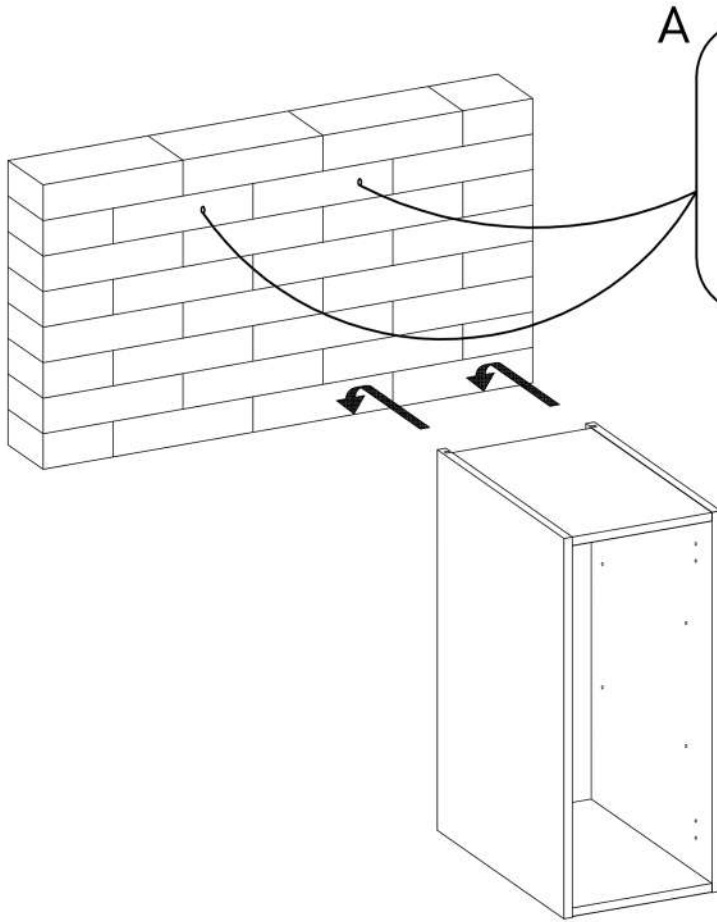
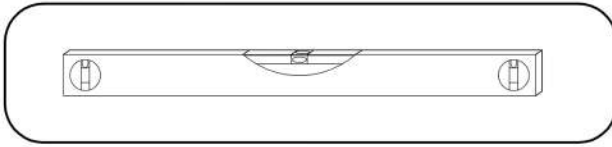

7

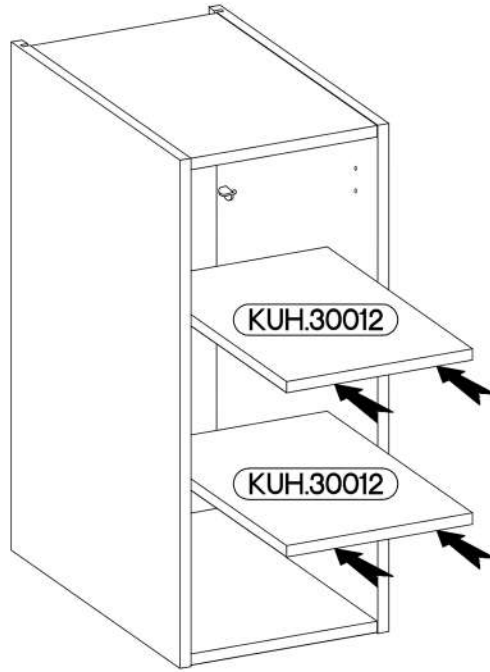
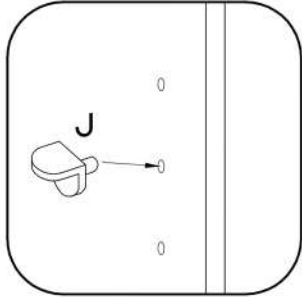
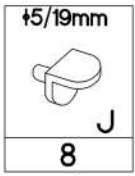

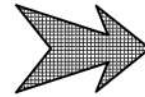
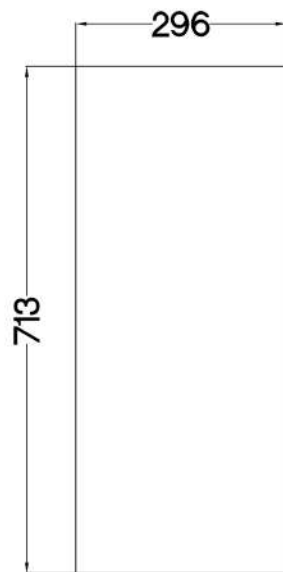

8

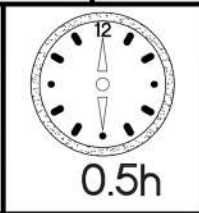
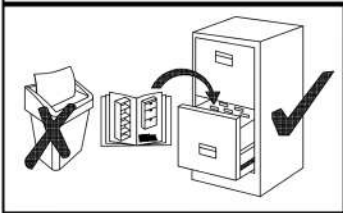
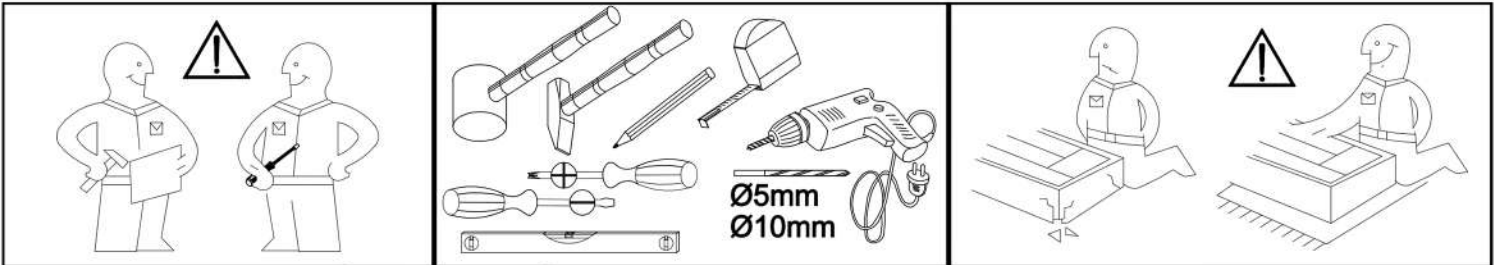

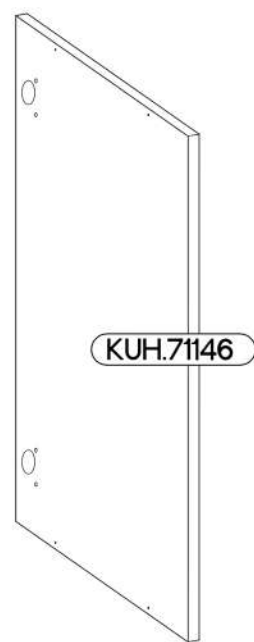
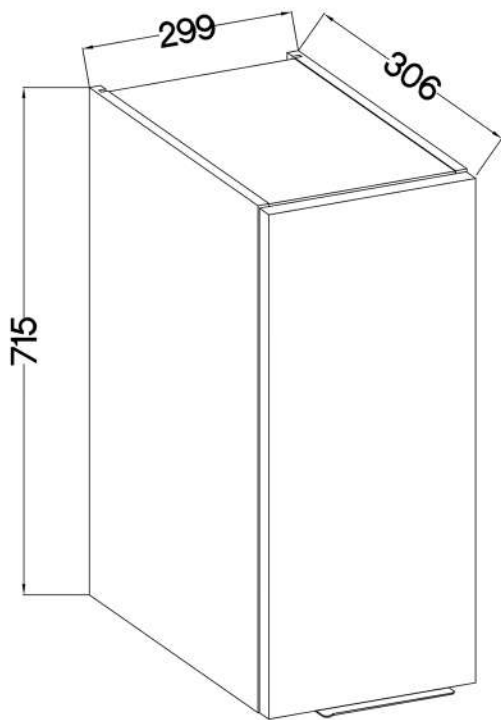
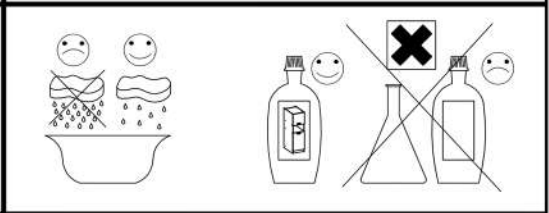

713x296



L=160mm	±7/2mm
	
S	J5
1	2

KUH.71146	713x296x16
-----------	------------

1

$\pm 35/0\text{mm}$ [CD] HG 2	$\pm 3.5 \times 13\text{mm}$ P5 4	$\pm 7/2\text{mm}$ J5 2
--	---	-------------------------------

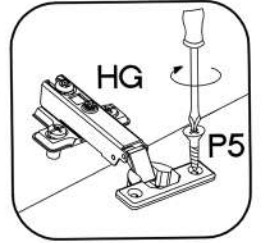
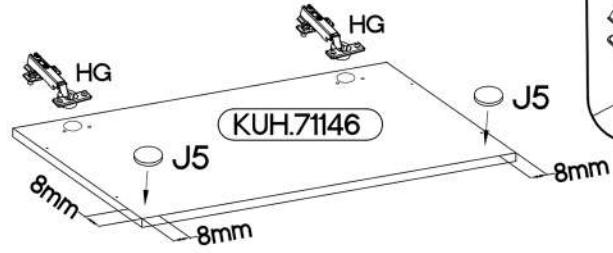
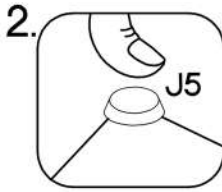
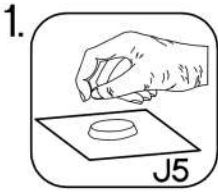

2

L=160mm S 1

