

ARSANY 40 G-108 1F

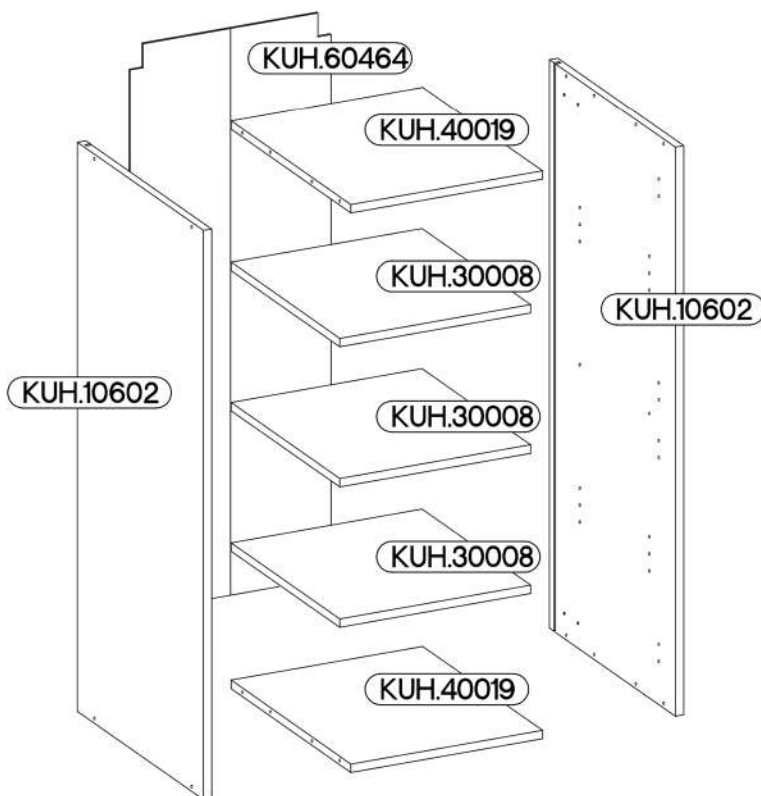

KUH.10602 x2	1073x290x16
KUH.30008 x3	366x250x16
KUH.40019 x2	367x276x16
KUH.60464	1070x385x2,5

A 8	B 8	E1 8	HG 3			
J3 12	K 2	O 1	P5 6	P7 8-10	P8 4	

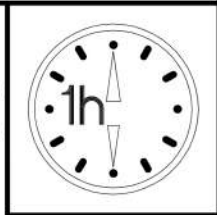
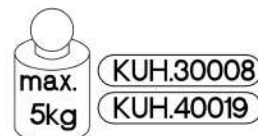
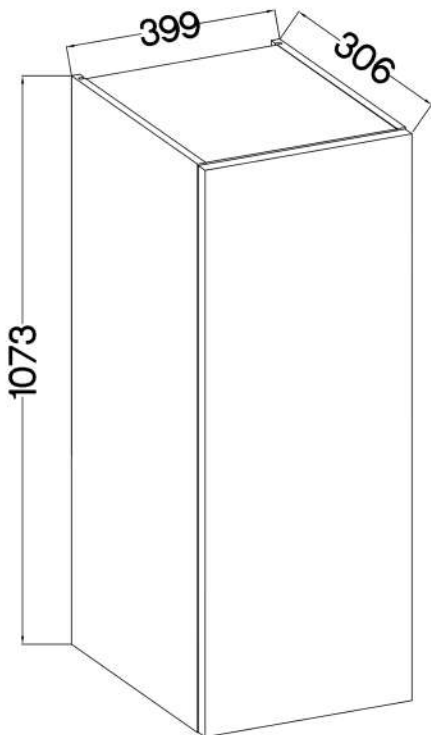
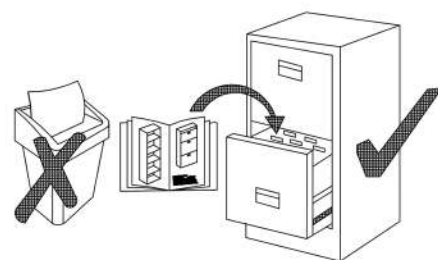

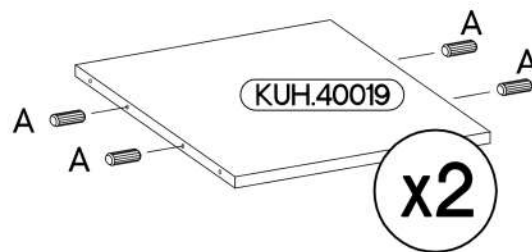
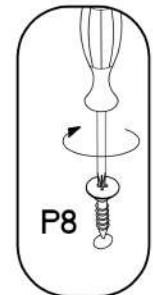
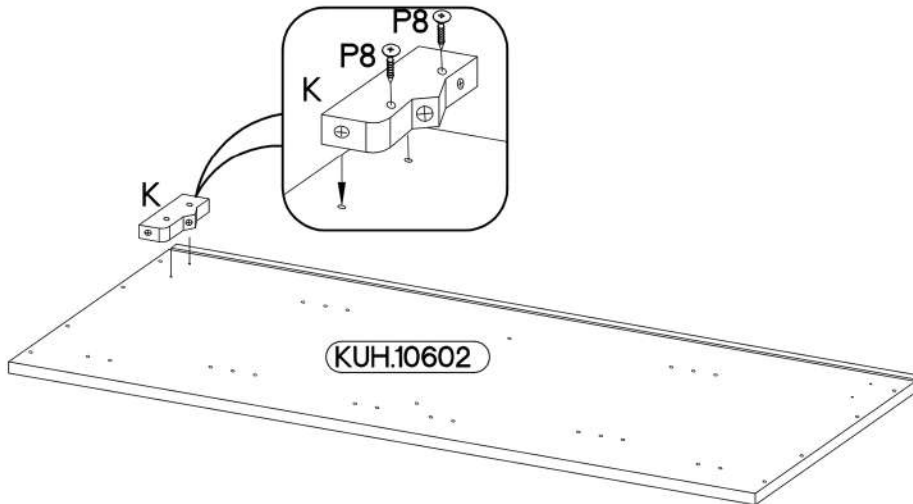
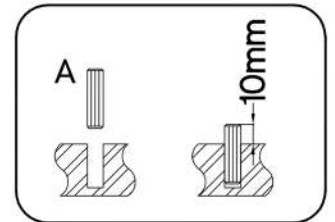
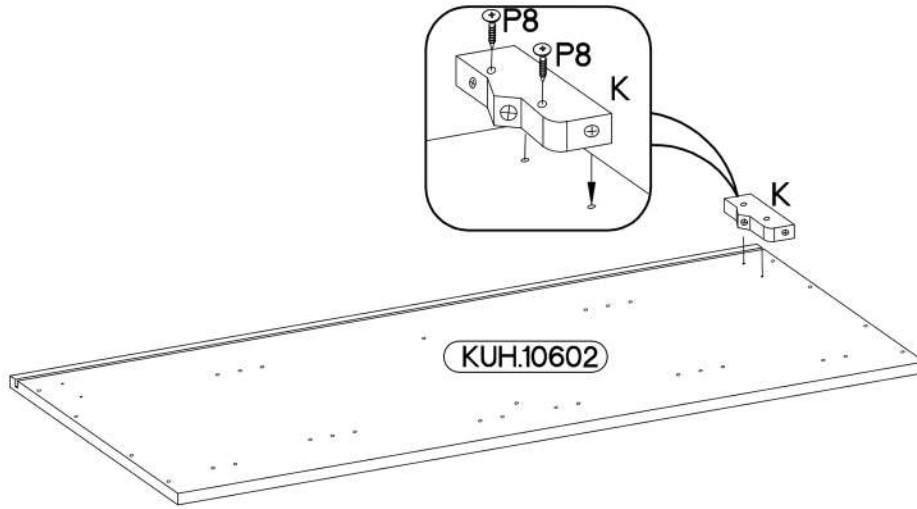
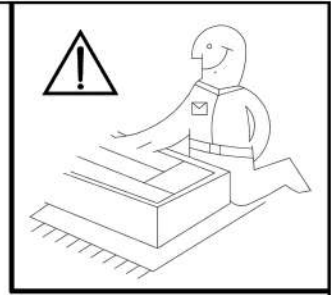

1

$\pm 8 \times 30 \text{mm}$ A 8	$\pm 4.0 \times 30 \text{mm}$ P8 4	K 2
---------------------------------------	--	--------





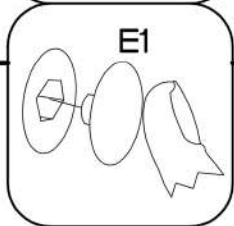
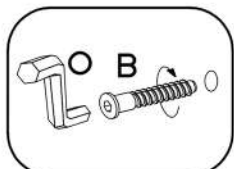
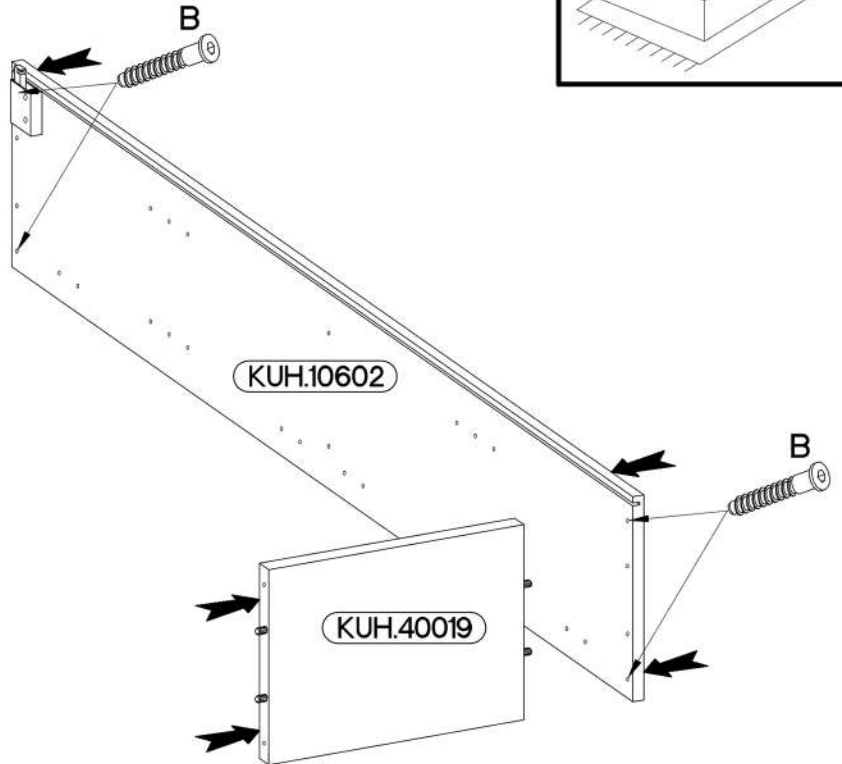
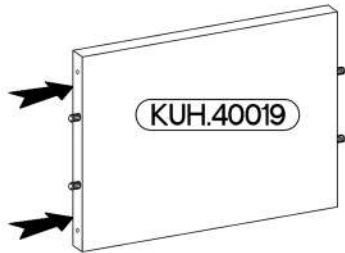

2

6,4 x 50mm		
		
B	O	E1
4	1	4

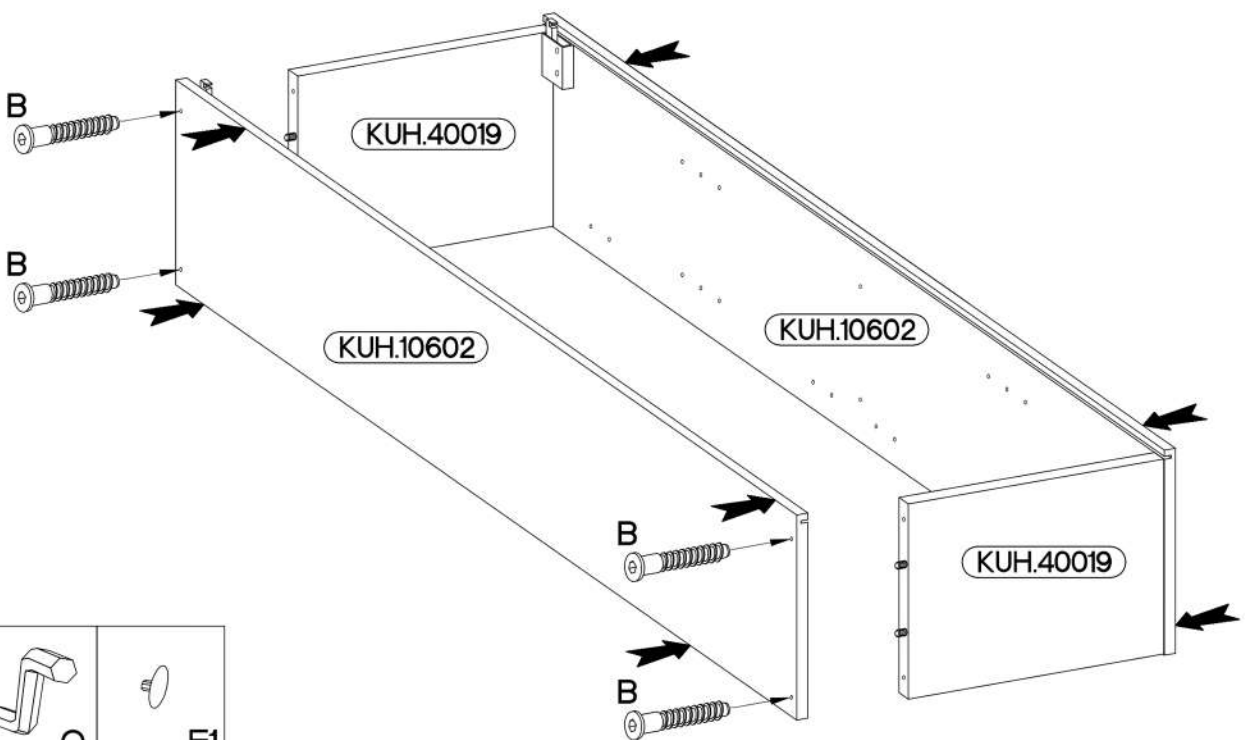

3



6,4 x 50mm		
		
B	O	E1
4	1	4

4

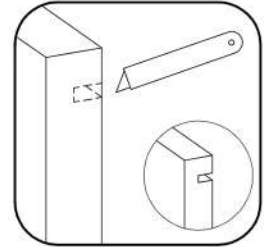
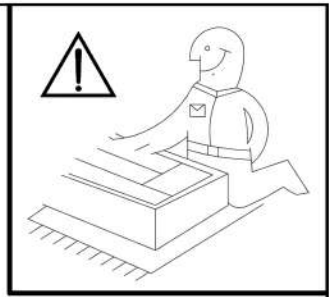
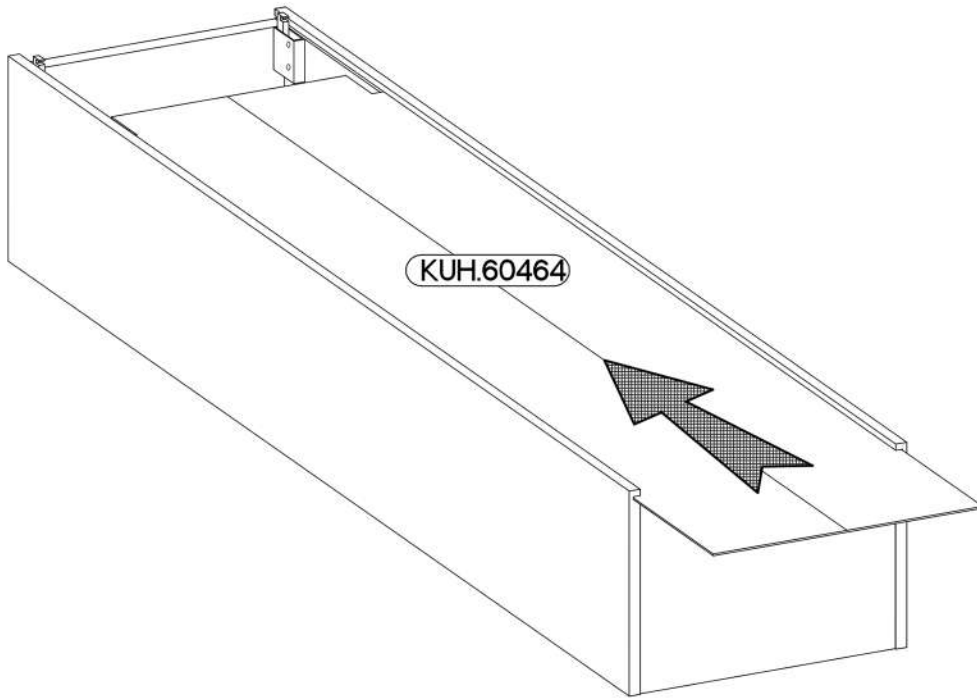

5

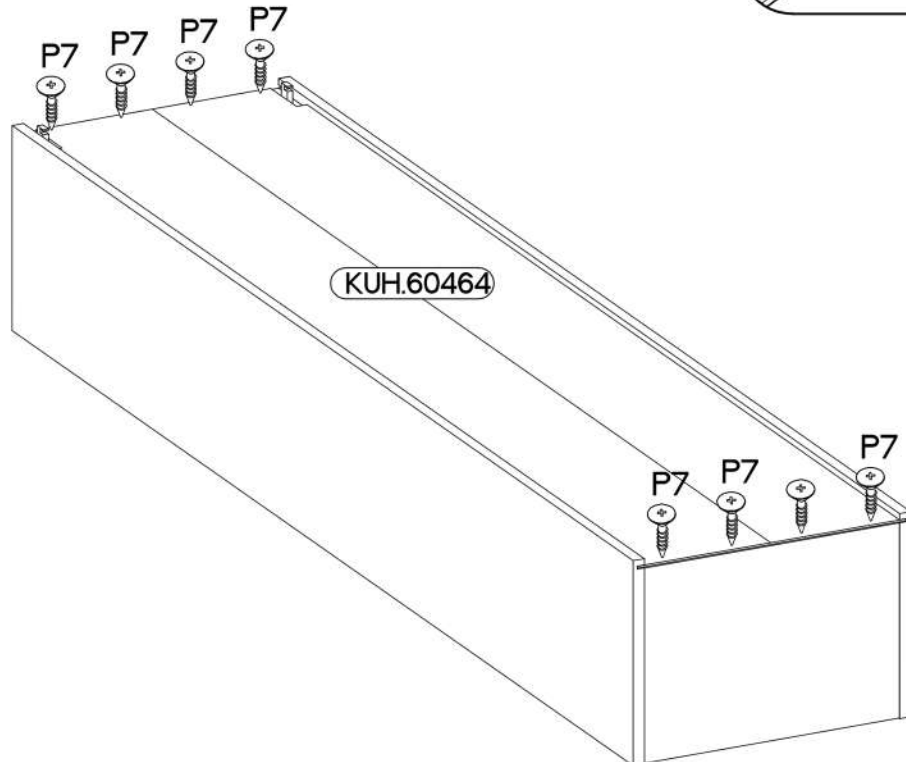
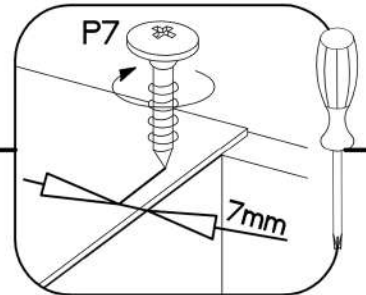
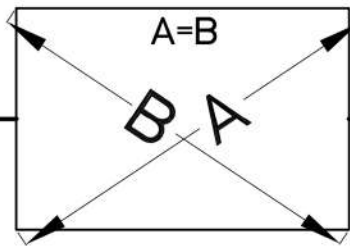
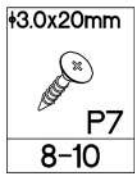

6

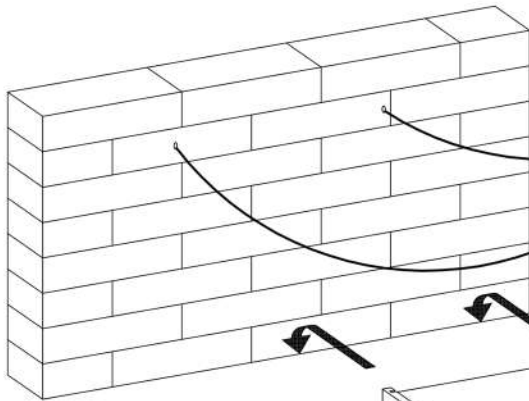
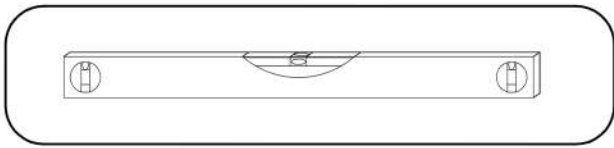

A



B

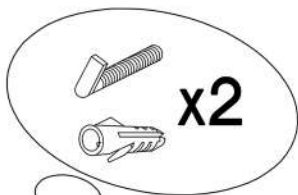
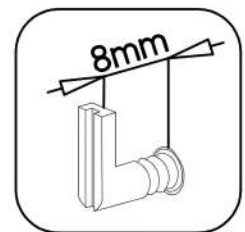
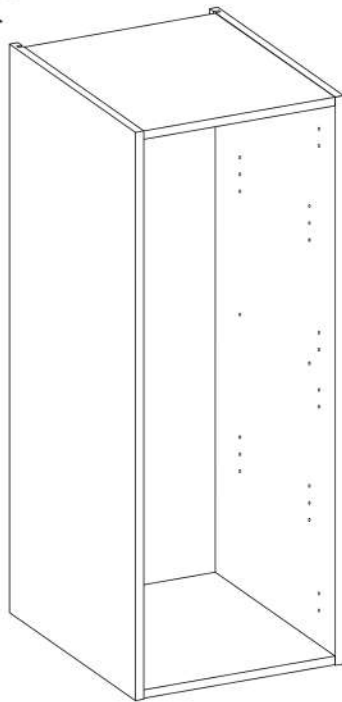
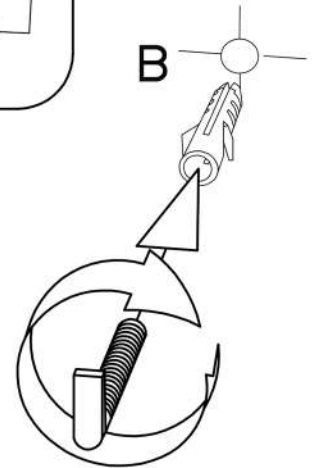

C

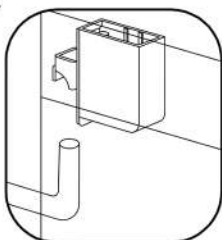

D

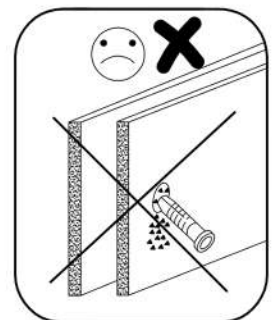
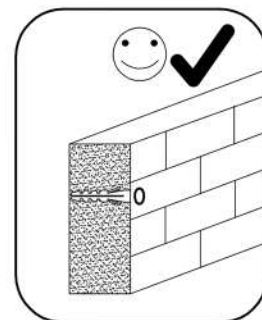
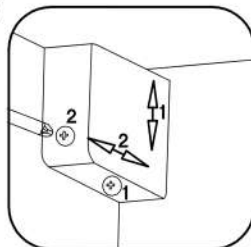

7

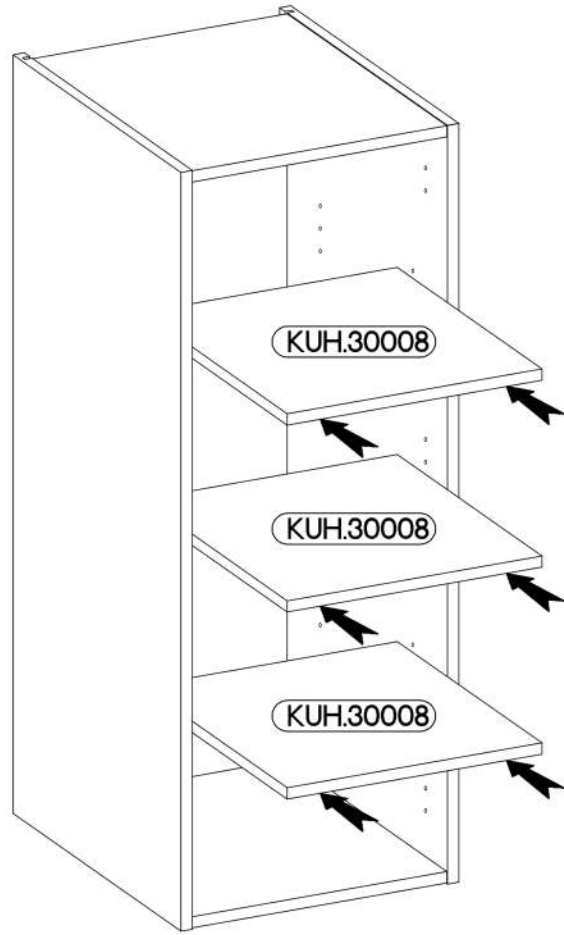
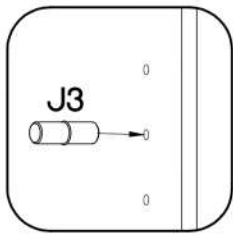
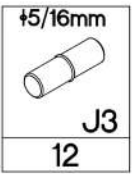

8

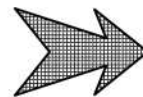
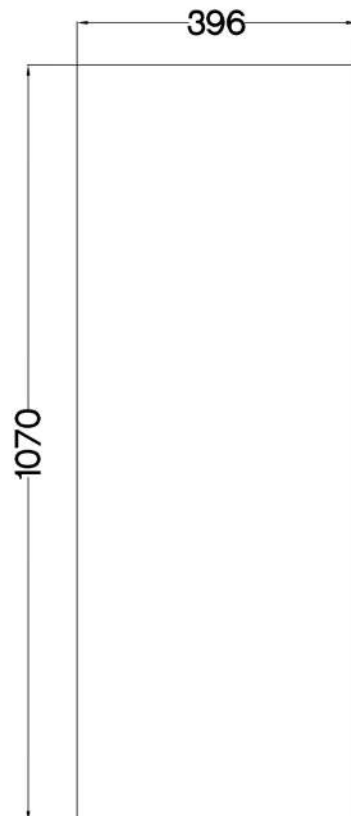

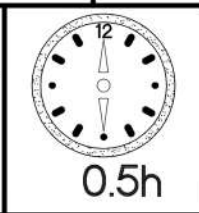
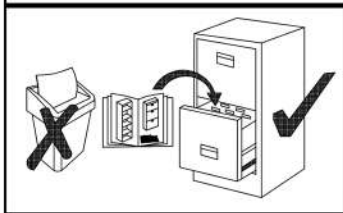
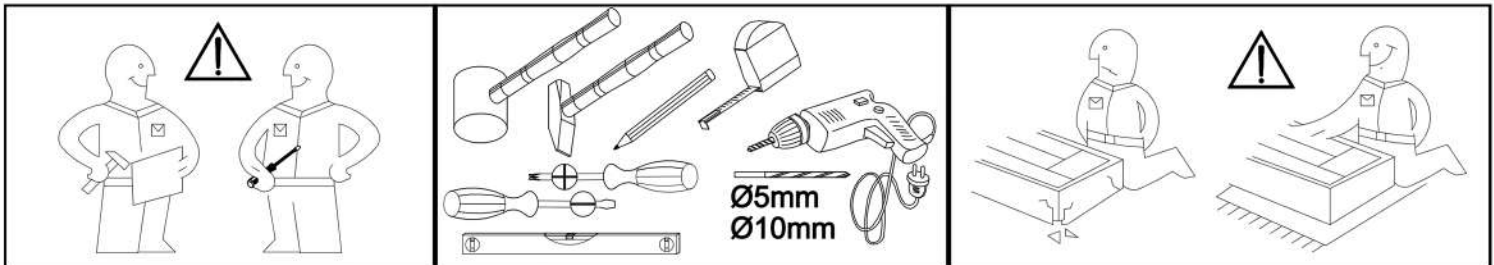

1070x396

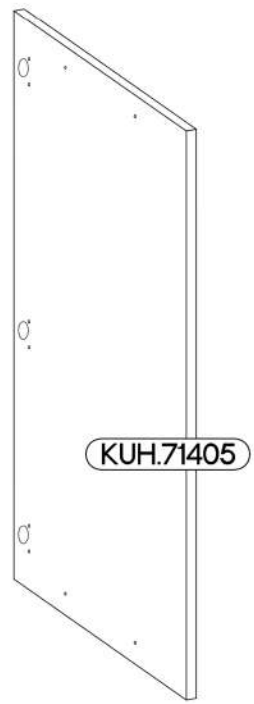
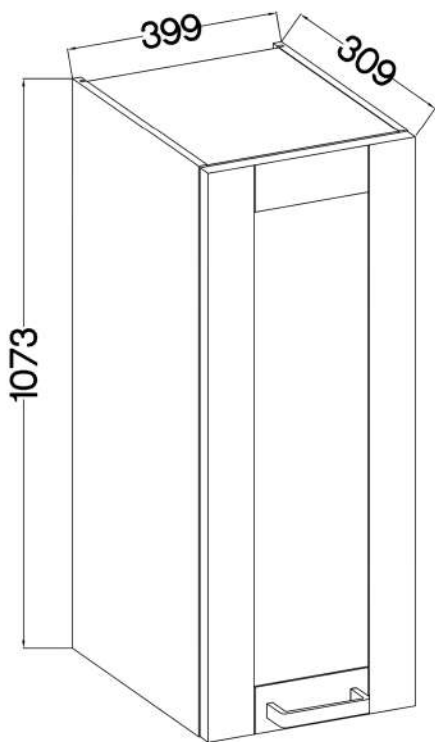
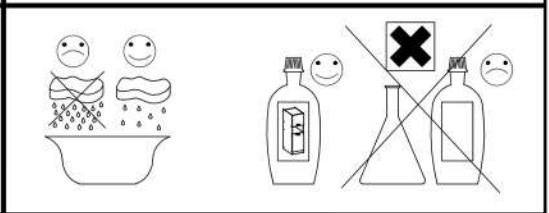

L=160mm	M4x27mm
S	U8
1	2

KUH.71405	1070x396x19
-----------	-------------

1

LEFT

RIGHT





KUH.71405

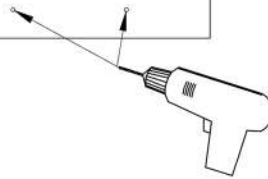
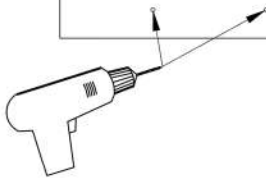
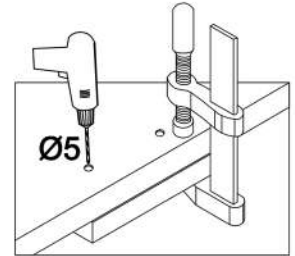

KUH.71405



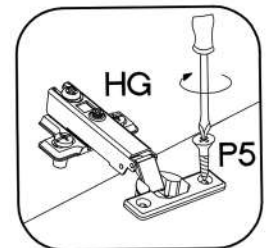
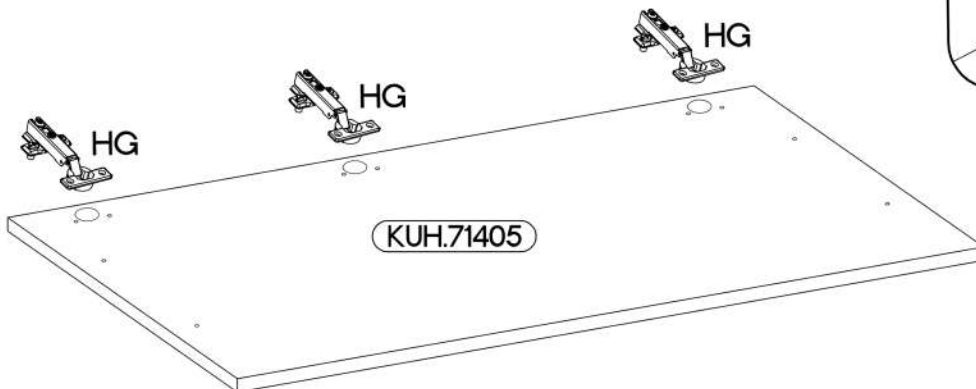

2

 HG	 P5
3	6



3

L=160mm	M4x27mm
	
S	U8
1	2

