

# ARSANY 40 G-90 1F

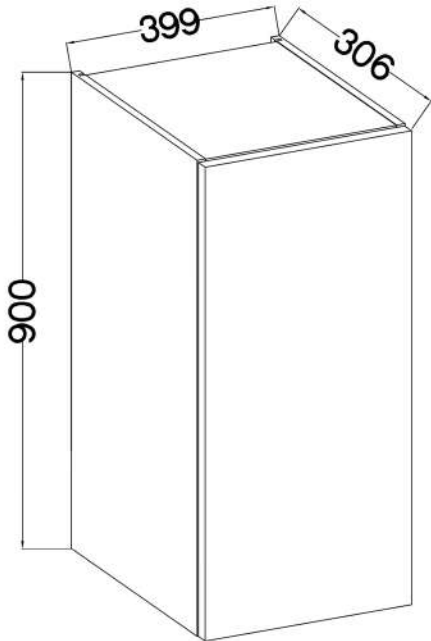

max. 5kg  
KUH.30008  
KUH.40019

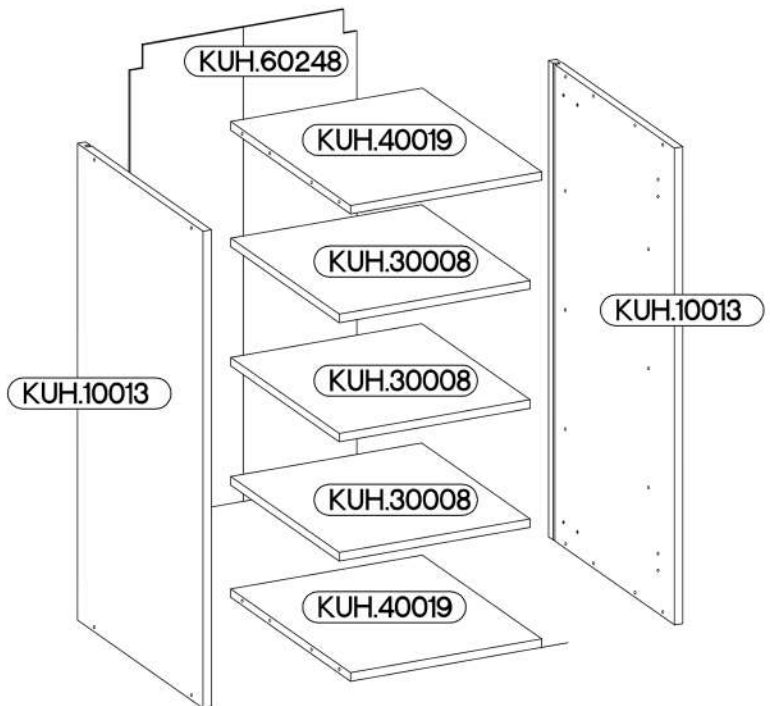

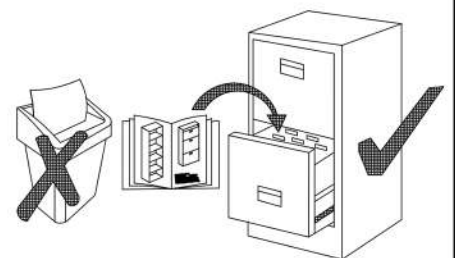

KUH.10013 x2	900x290x16
KUH.30008 x3	366x250x16
KUH.40019 x2	367x276x16
KUH.60248	896x385x2,5

$\pm 8 \times 30 \text{mm}$ A 8	$6,4 \times 50 \text{mm}$ B 8	E1 8	HG 2	$\pm 3,5 \times 13 \text{mm}$ P5 4	$\pm 3,0 \times 20 \text{mm}$ P7 8-10	$\pm 4,0 \times 30 \text{mm}$ P8 4
J 12	K 2	O 1				



1

$\pm 8 \times 30 \text{mm}$  A	$\pm 4.0 \times 30 \text{mm}$  P8	 K
8	4	2

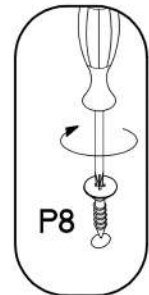
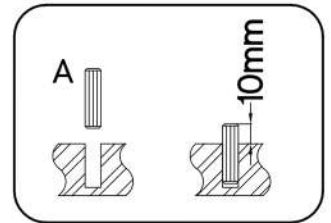
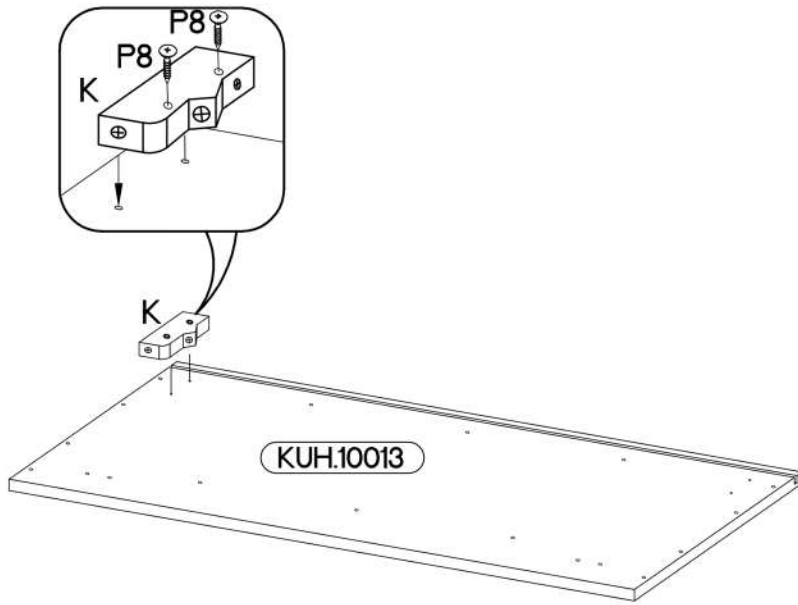
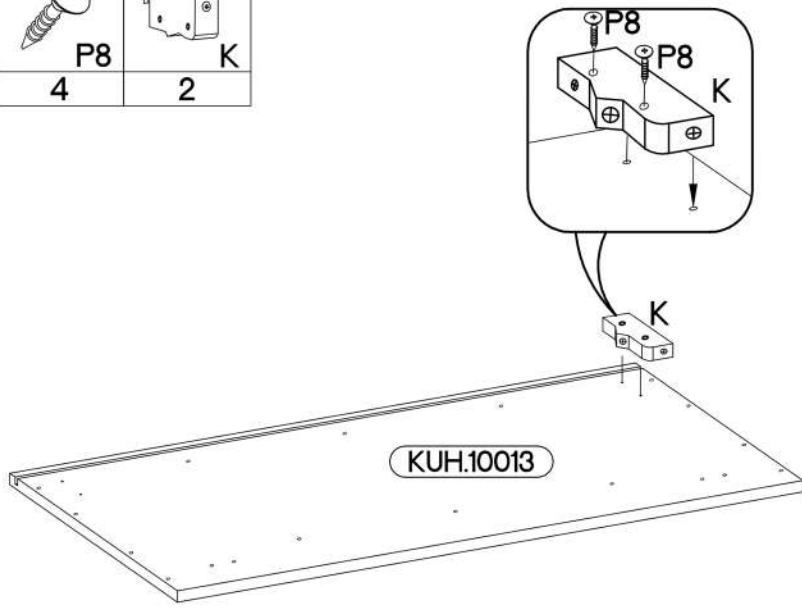
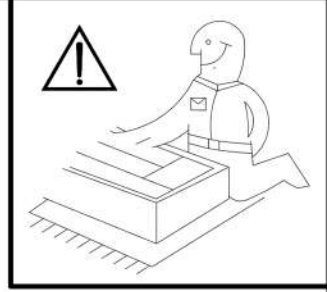

2

6,4 x 50mm

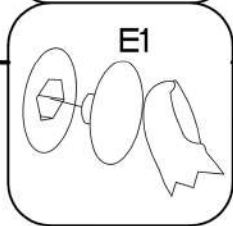
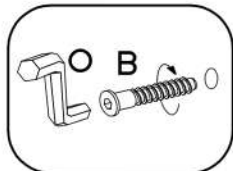
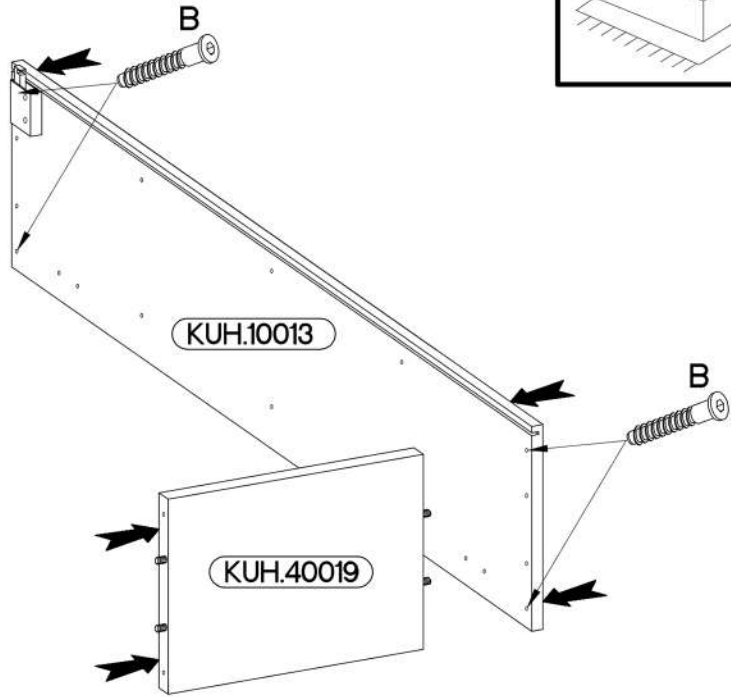
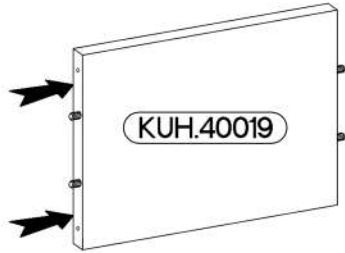
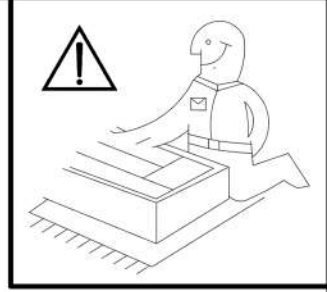
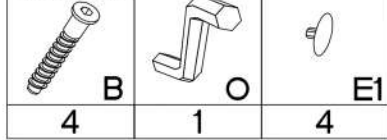

3

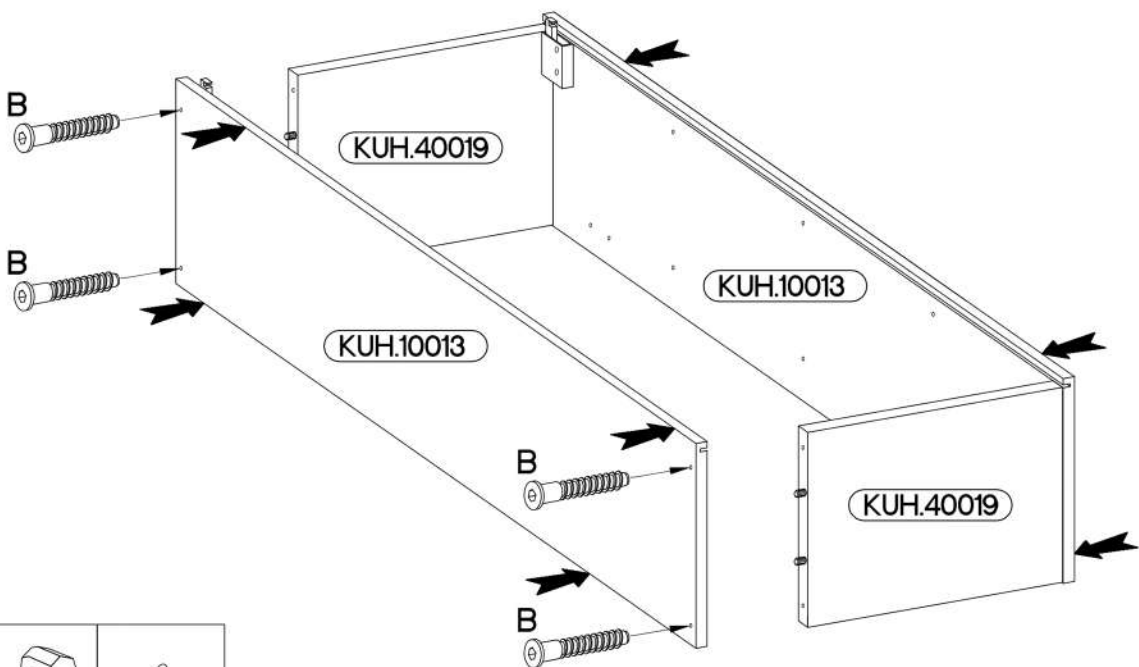

6,4 x 50mm

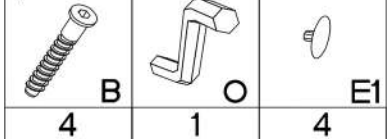

4

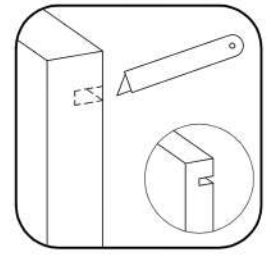
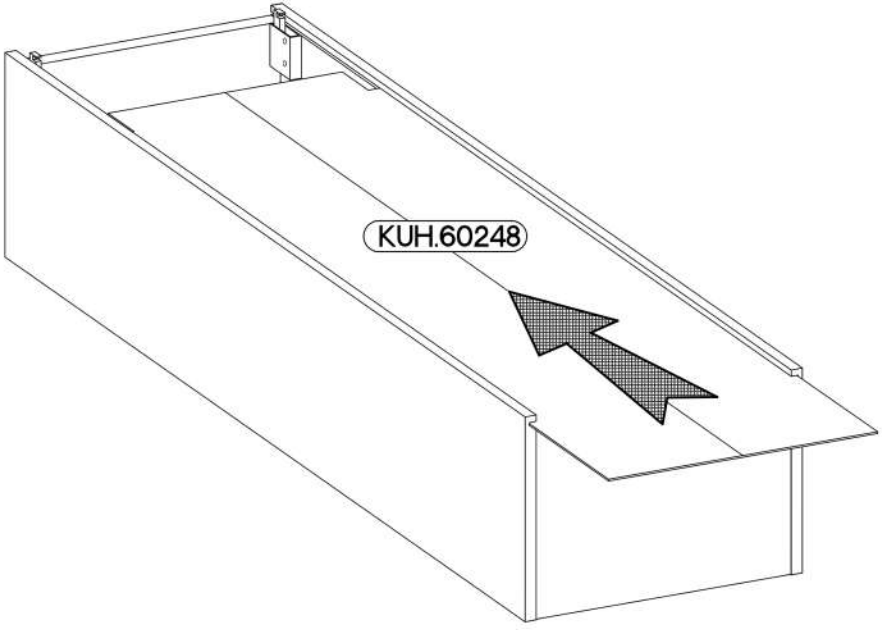
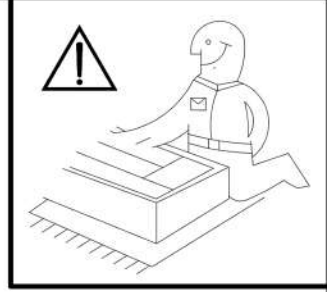

5

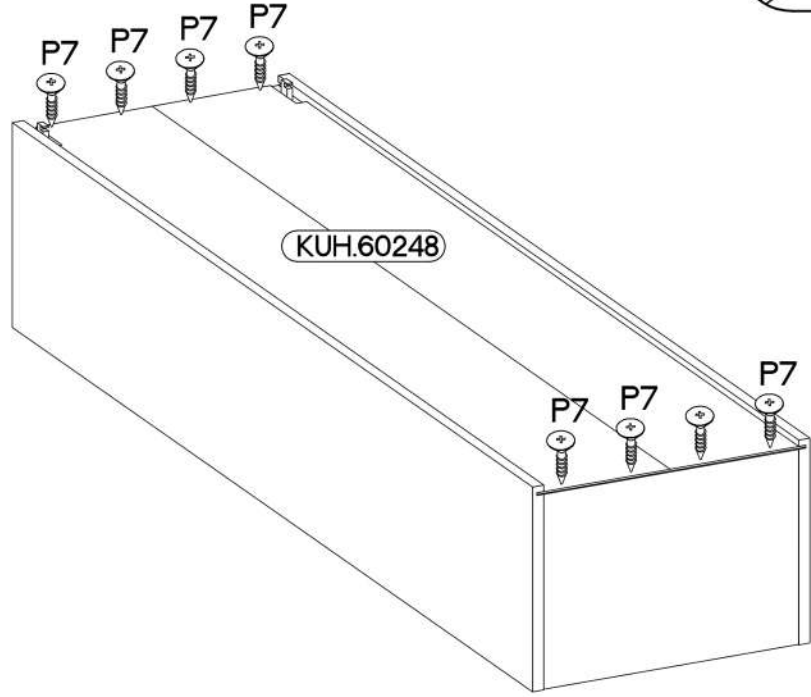
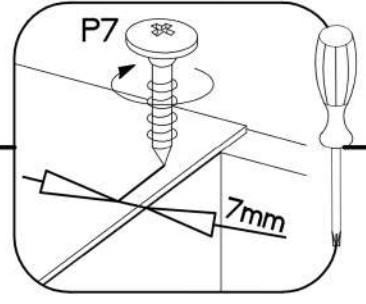
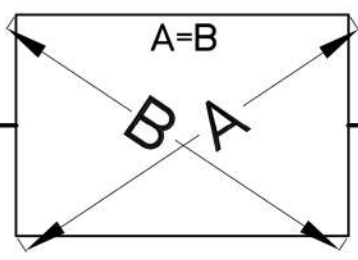
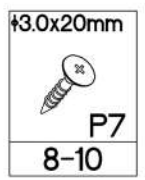

6

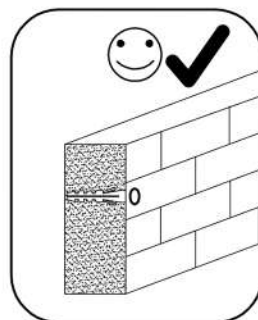
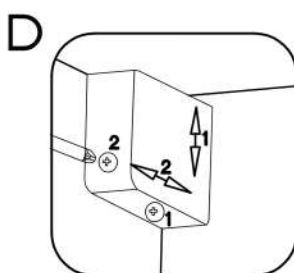
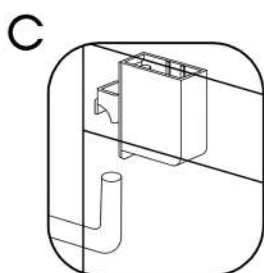
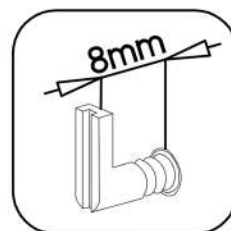
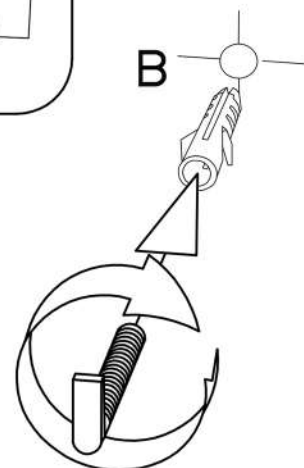
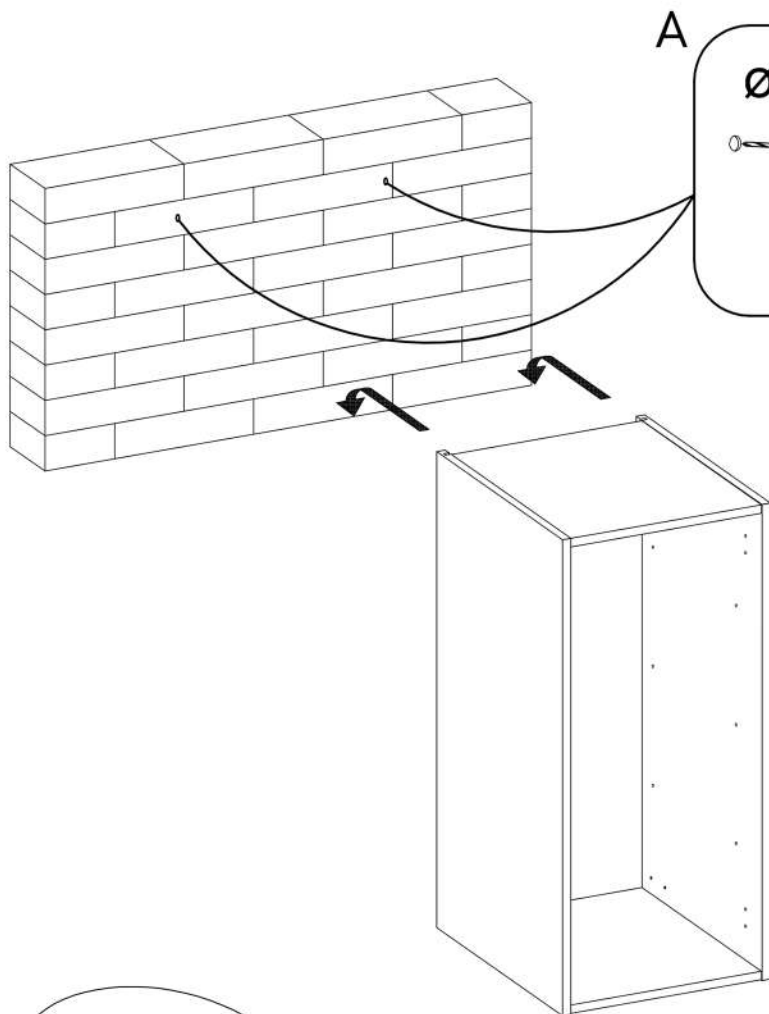
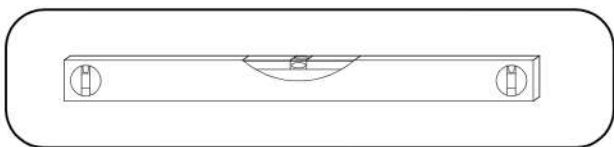

7

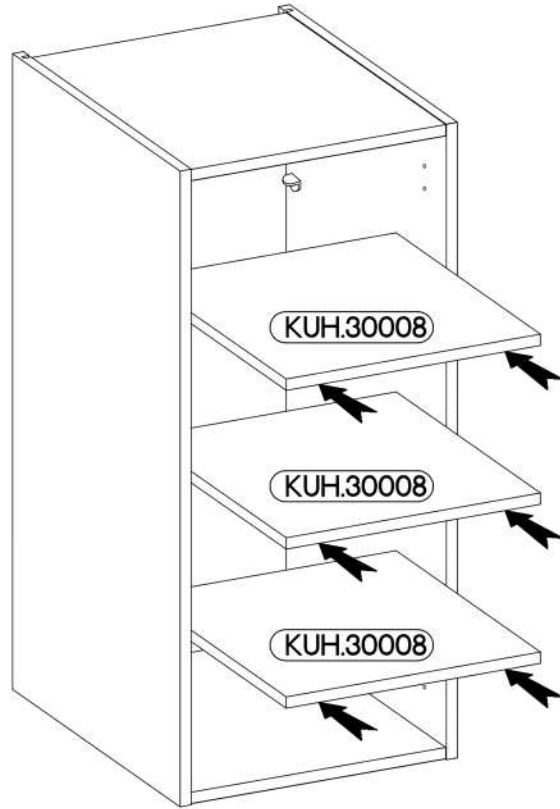
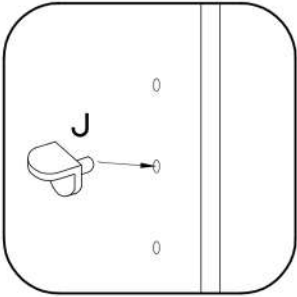
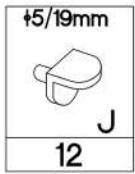

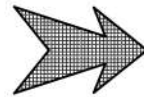
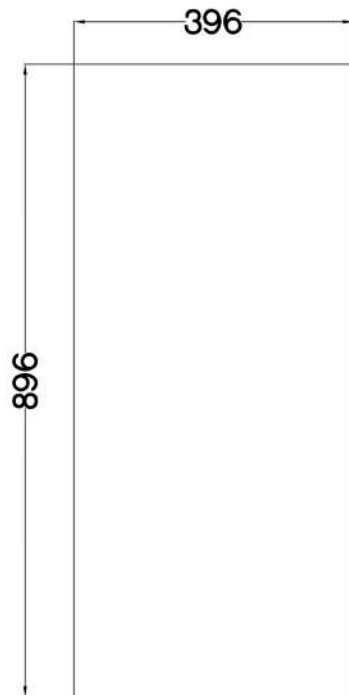

8

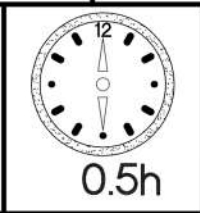
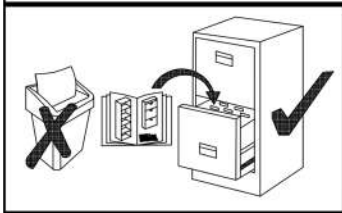
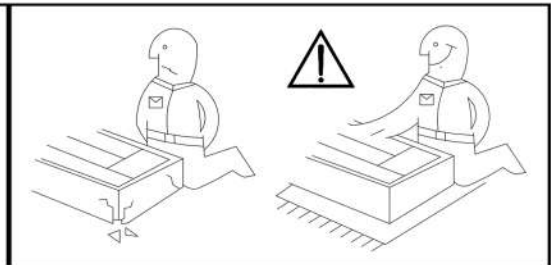
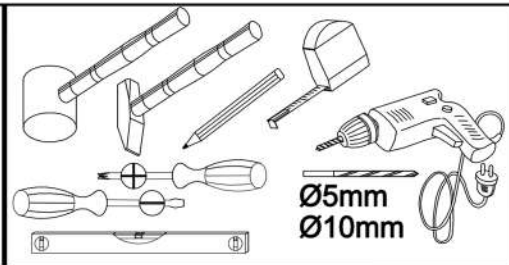
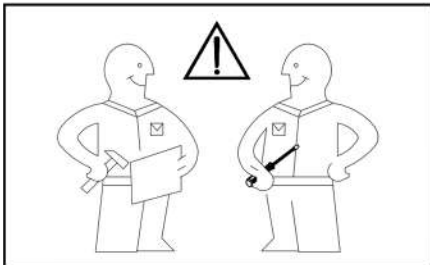

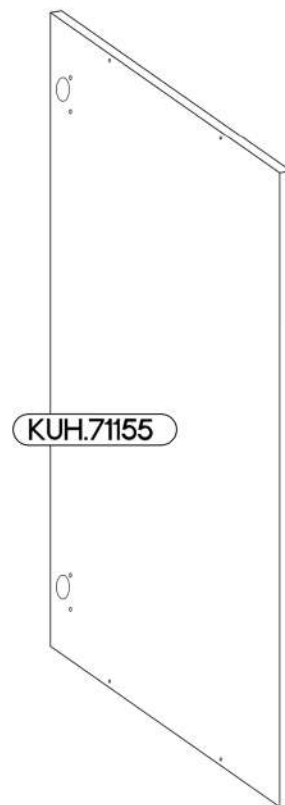
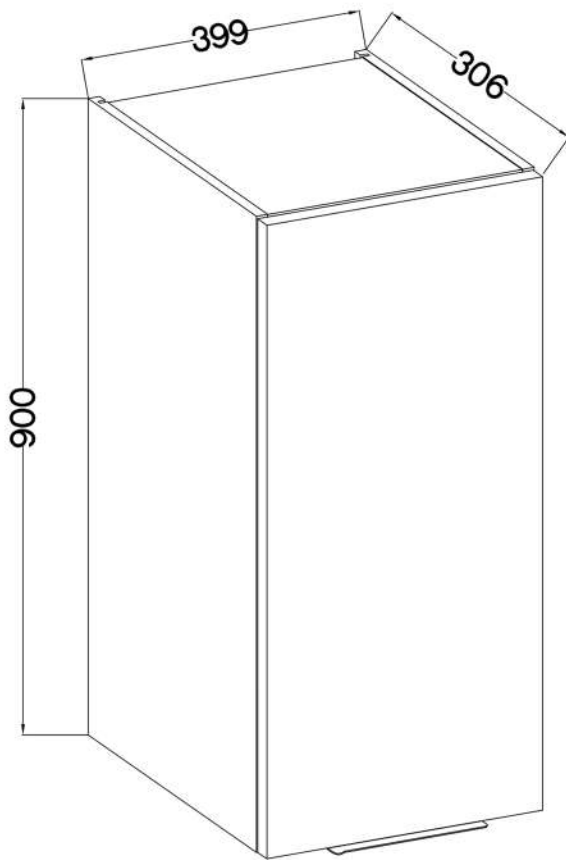
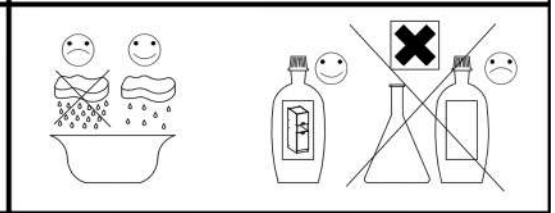

**896x396**



L=192mm	+7/2mm
	
S	J5
1	2

KUH.71155	896x396x16
-----------	------------

# 1

$\pm 35/0\text{mm}$ [CD] HG 2	$\pm 3.5 \times 13\text{mm}$ P5 4	$\pm 7/2\text{mm}$ J5 2
-------------------------------------	---	-------------------------------

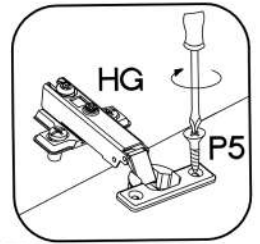
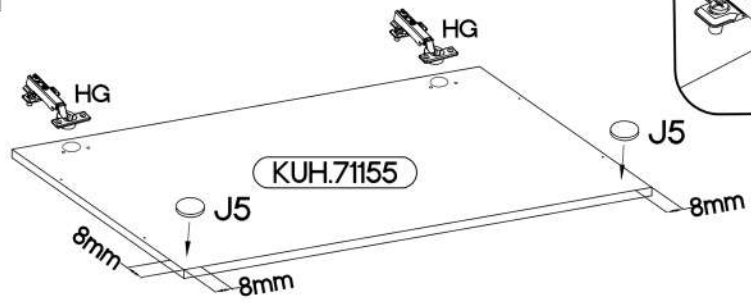
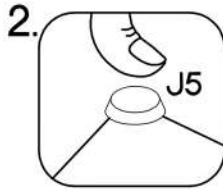
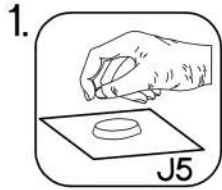

# 2

L=192mm 	S 1
-------------	--------

