

ARSANY 45 G-90 1F

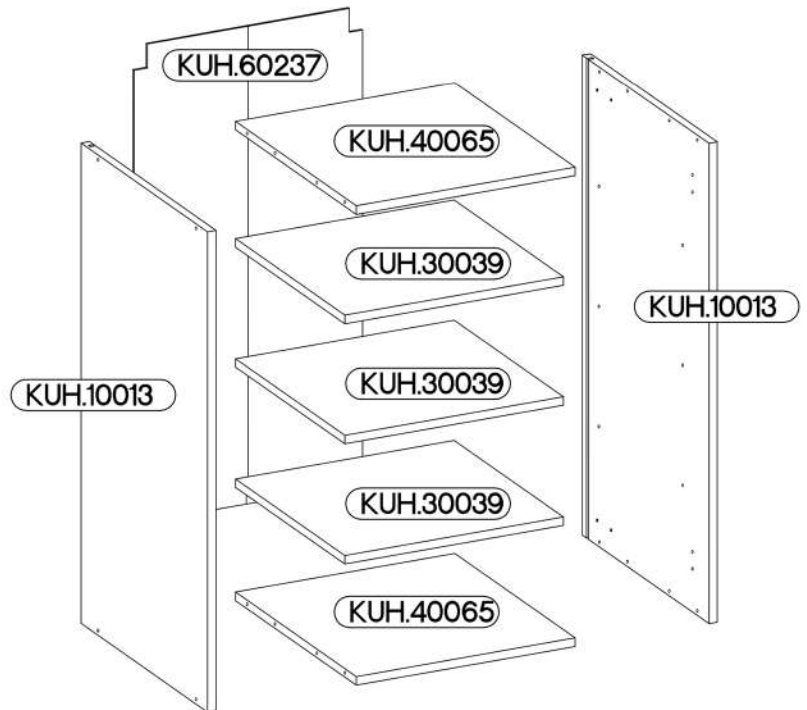

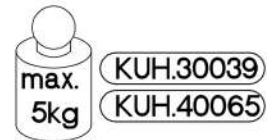
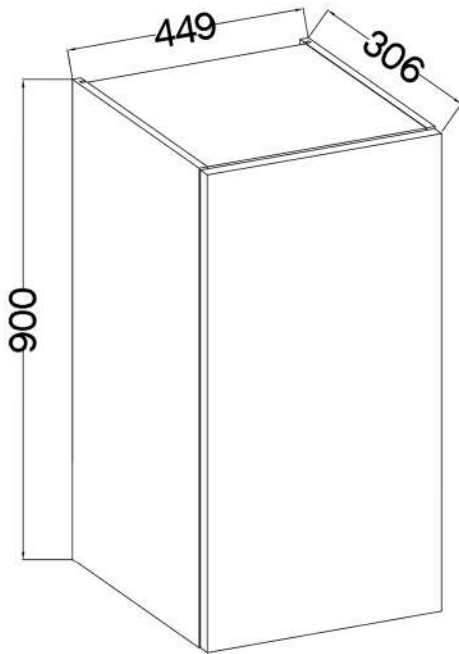
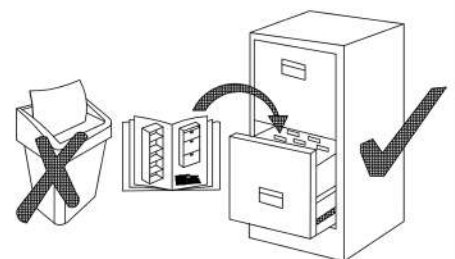

KUH.10013 x2	900x290x16
KUH.30039 x3	416x250x16
KUH.40065 x2	417x276x16
KUH.60237	896x435x2,5

+8x30mm A 8	6,4 x 50mm B 8	E1 8	+35/0mm HG 2
+5/19mm J 12	K 2	O 1	+3.5x13mm P5 4
			+3.0x20mm P7 8-10
			+4.0x30mm P8 4



1

$\pm 8 \times 30 \text{mm}$  A 8	$\pm 4.0 \times 30 \text{mm}$  P8 4	 K 2
--	---	---

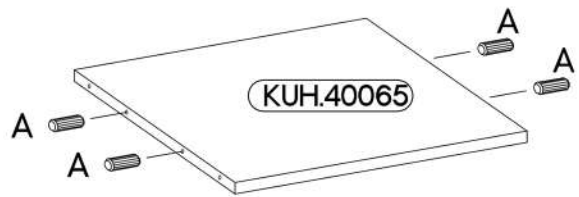
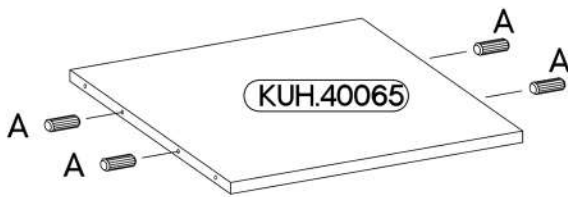
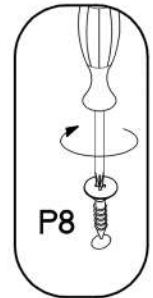
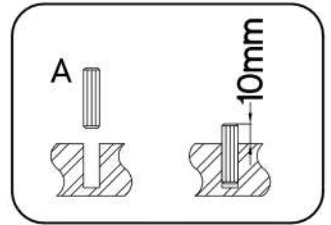
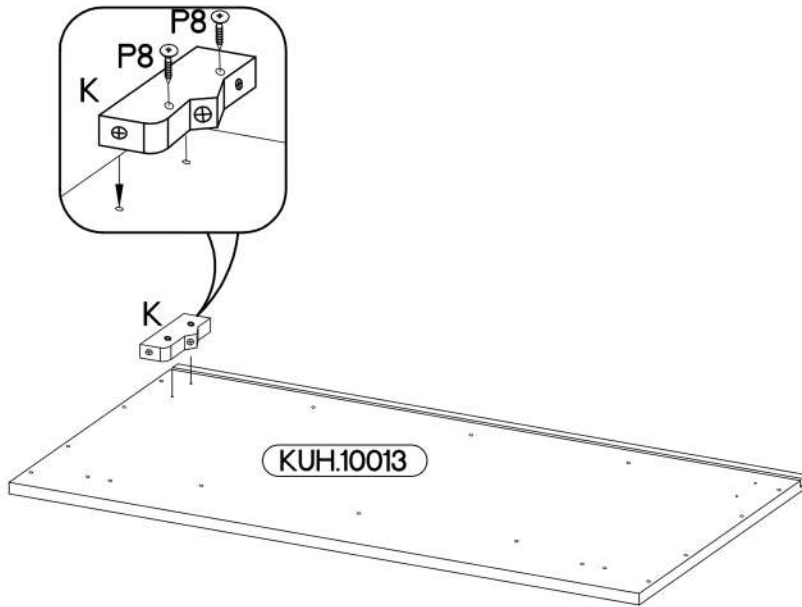
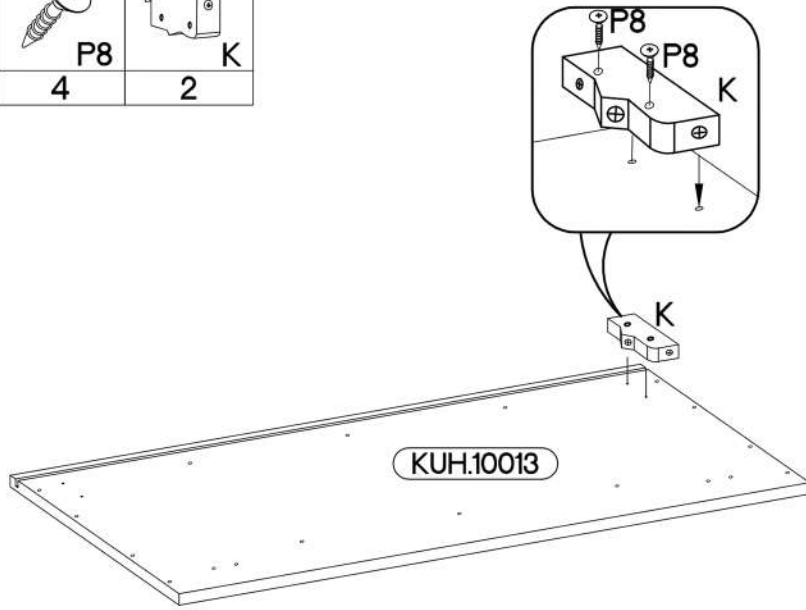
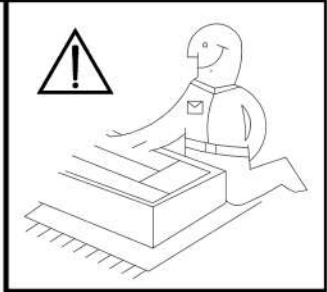

2

6,4 x 50mm

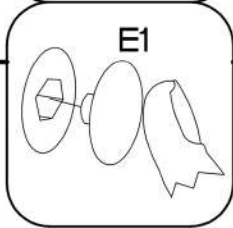
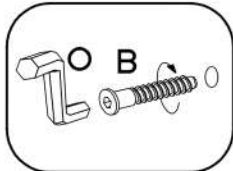
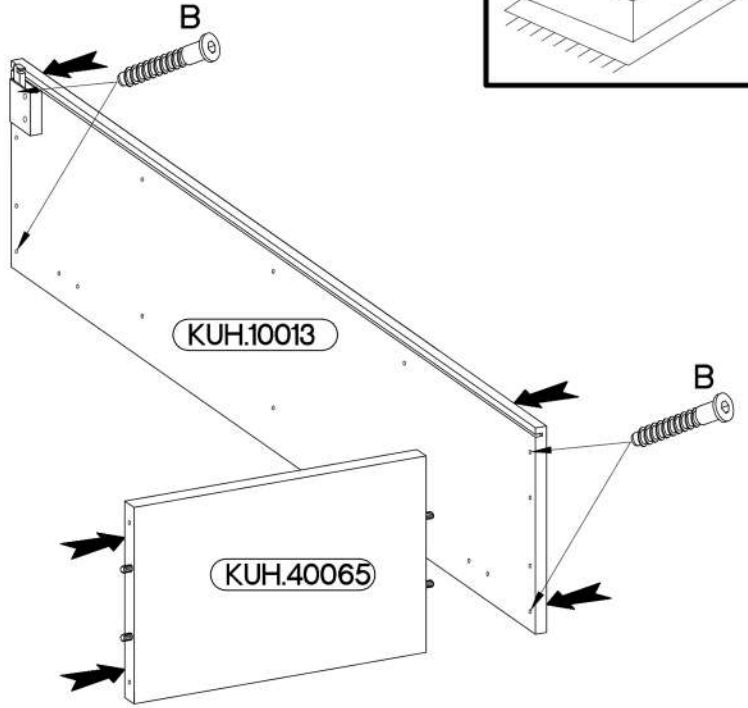
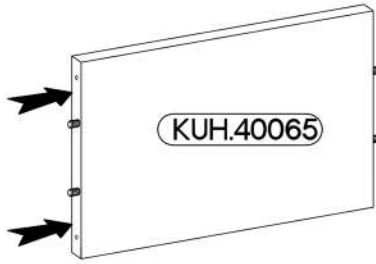
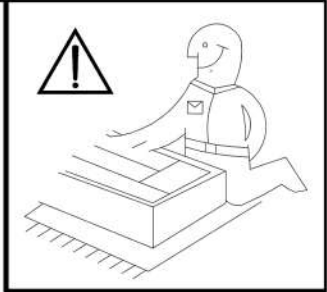
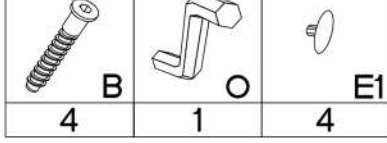

3

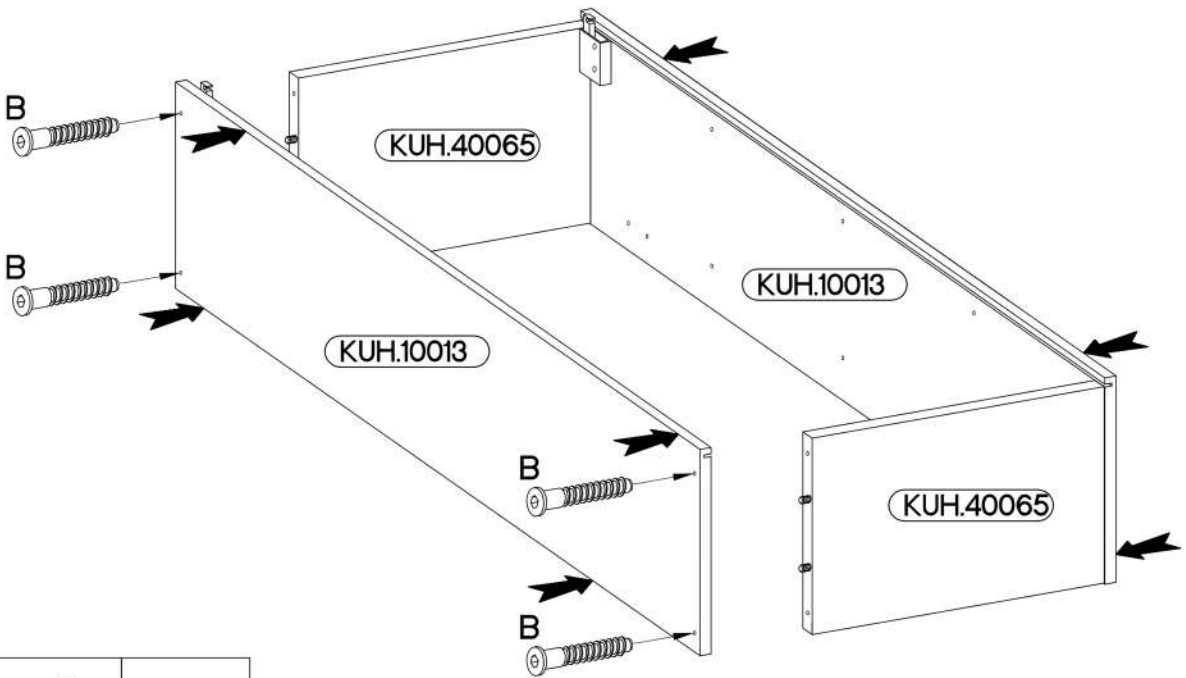

6,4 x 50mm

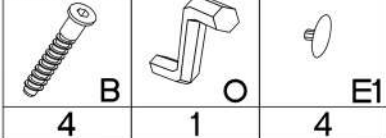

4

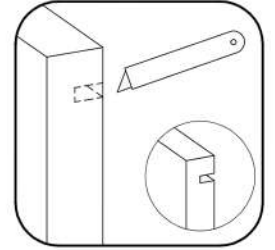
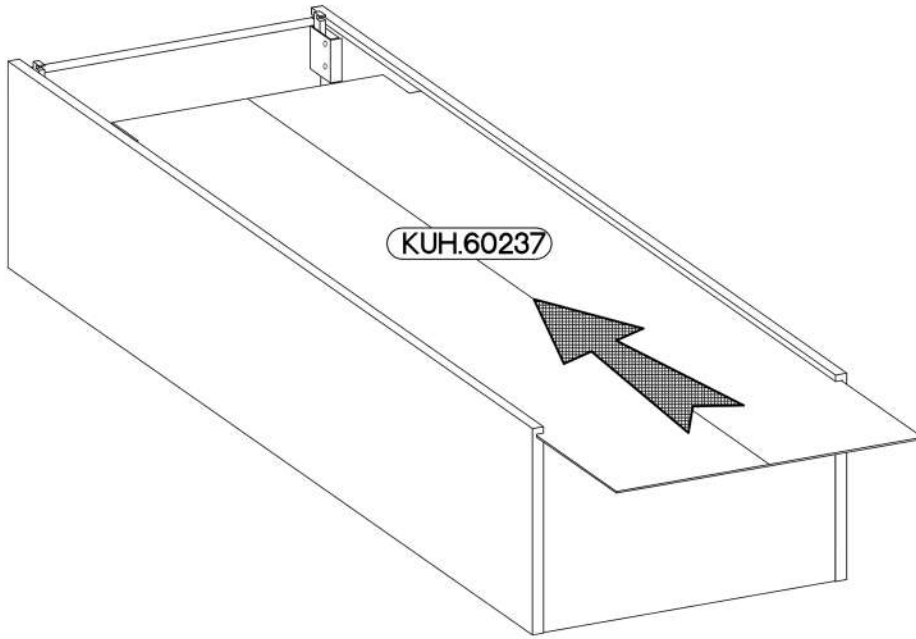

5

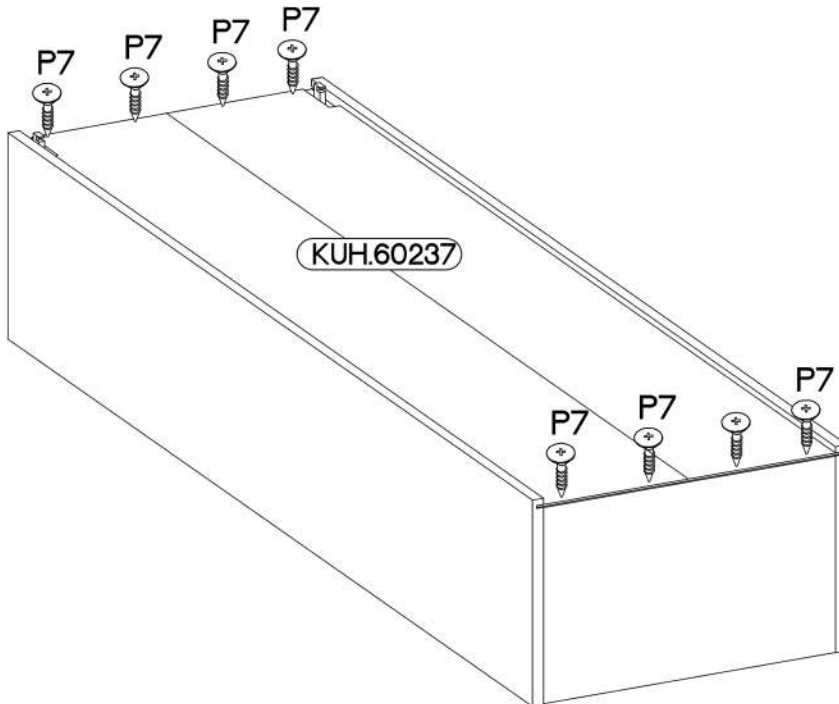
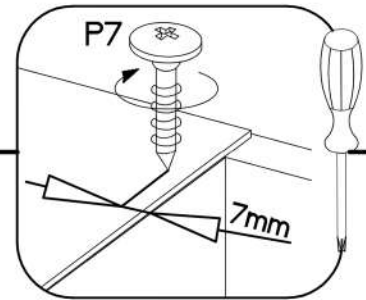
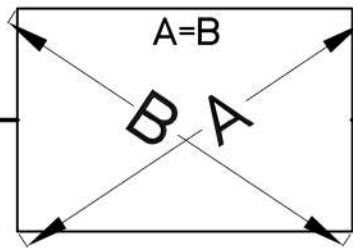
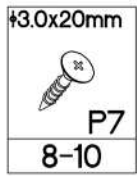

6

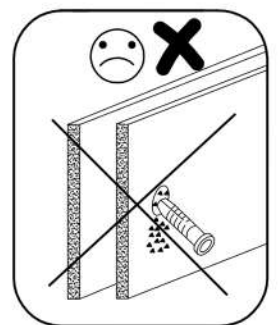
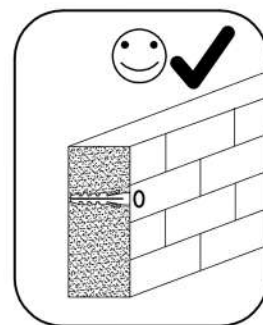
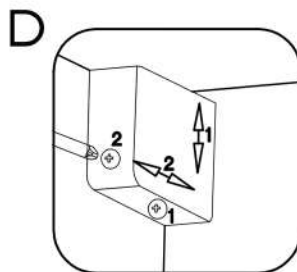
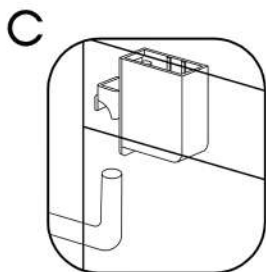
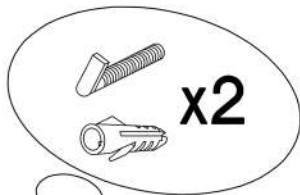
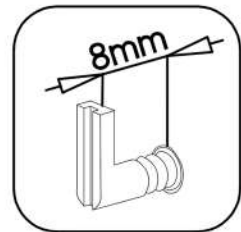
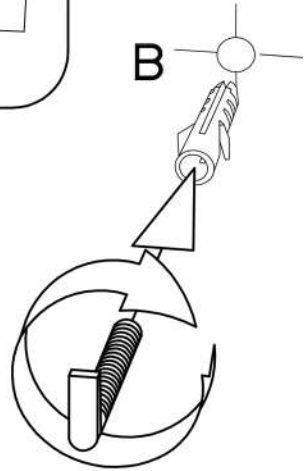
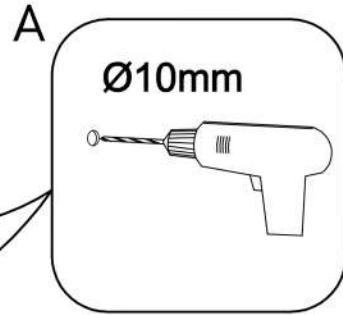
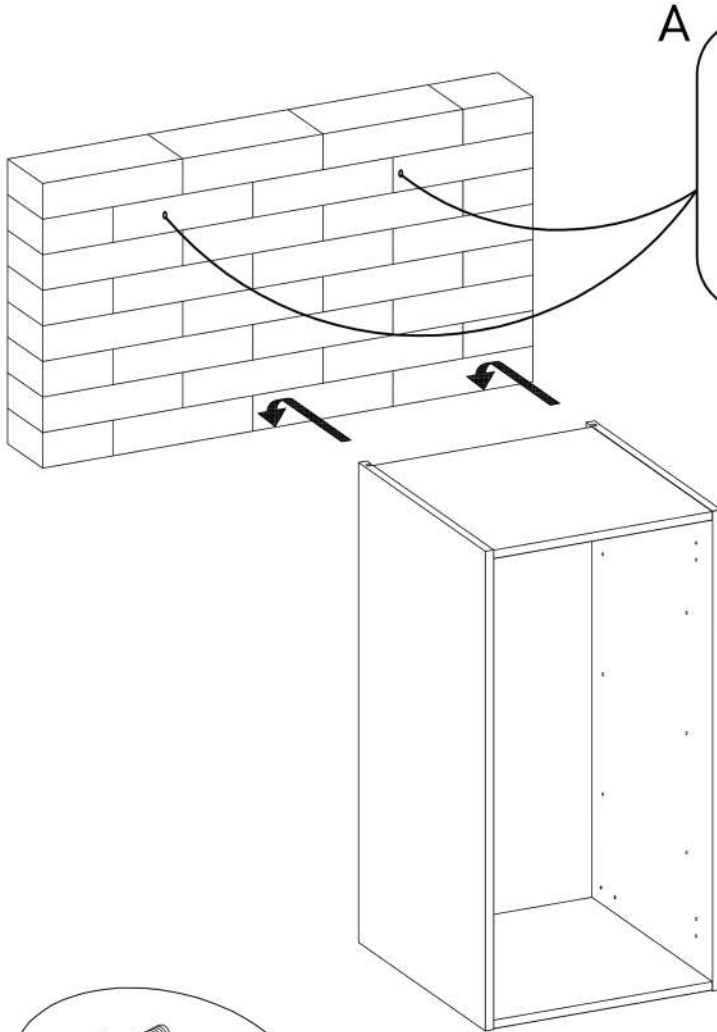
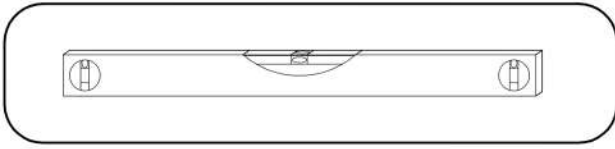

7

+5/19mm
J
12

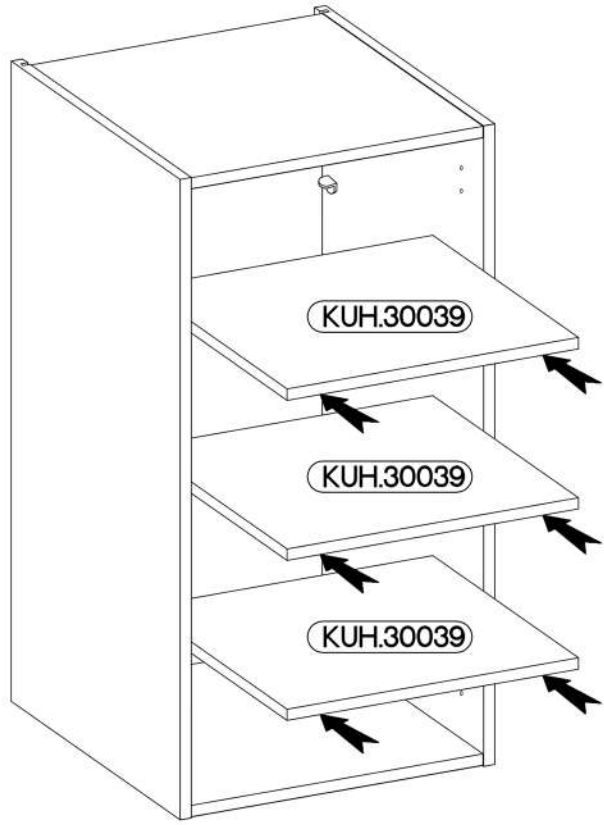
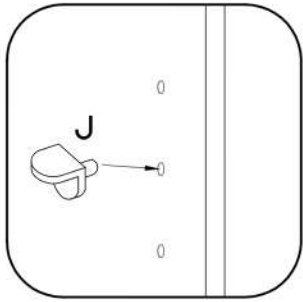

8

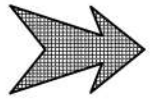
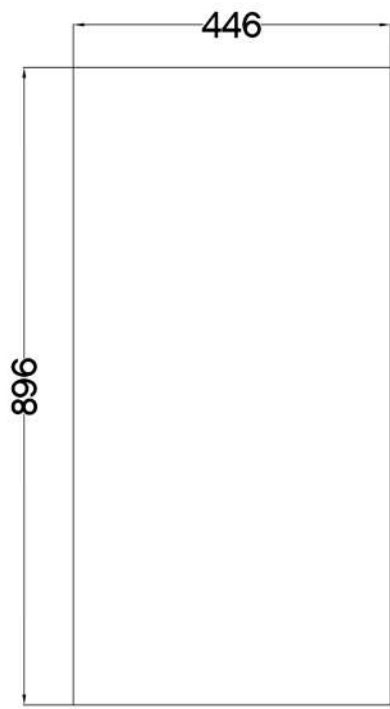

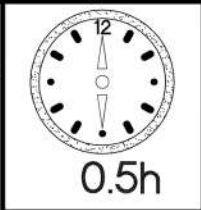
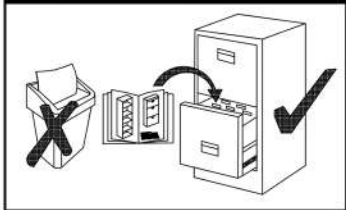
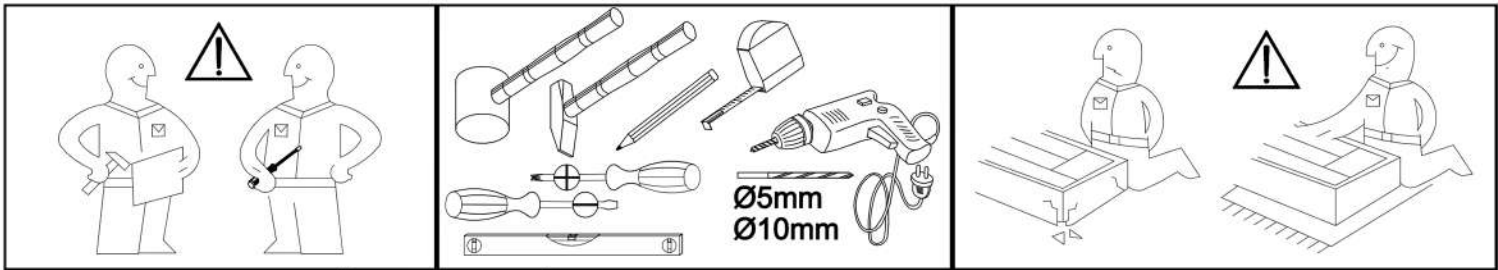

896x446

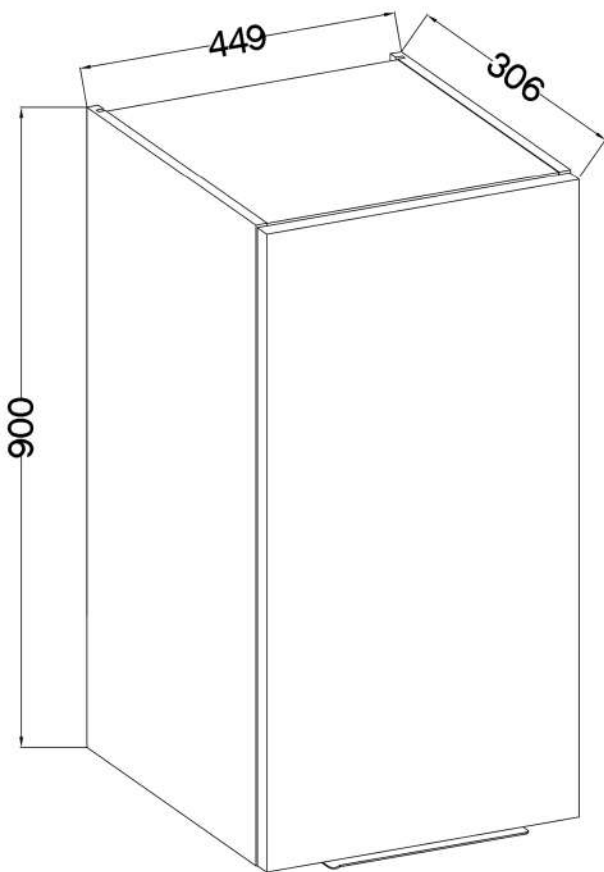
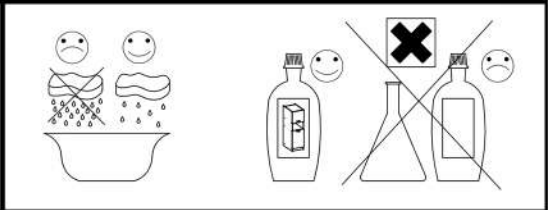

L=256mm	±7/2mm
S	J5
1	2

KUH.71157	896x446x16
-----------	------------

1

$\pm 35/0\text{mm}$ [CD] HG 2	$\pm 3.5 \times 13\text{mm}$ P5 4	$\pm 7/2\text{mm}$ J5 2
-------------------------------------	---	-------------------------------

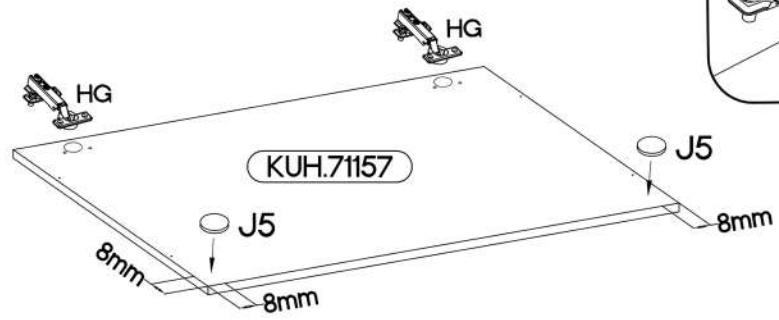
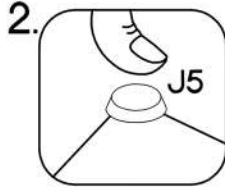
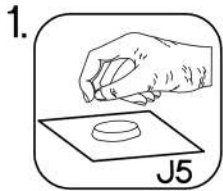
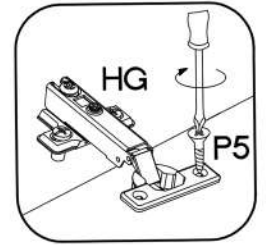

2

L=256mm S 1

